

EXPLORING THE REACTIONS OF SMALL RINGS

**Submitted in partial fulfilment of the
requirements of the
Degree of Doctor of Philosophy**

by

Siobhán Hackett

School of Biological and Chemical Sciences

September 2014

Statement of Originality

I, Siobhán Hackett, confirm that the research included within this thesis is my own work or that where it has been carried out in collaboration with, or supported by others, that this is duly acknowledged below and my contribution indicated. Previously published material is also acknowledged below.

I attest that I have exercised reasonable care to ensure that the work is original, and does not to the best of my knowledge break any UK law, infringe any third party's copyright or other Intellectual Property Right, or contain any confidential material.

I accept that the College has the right to use plagiarism detection software to check the electronic version of the thesis.

I confirm that this thesis has not been previously submitted for the award of a degree by this or any other university.

The copyright of this thesis rests with the author and no quotation from it or information derived from it may be published without the prior written consent of the author.

Signature: Siobhán Hackett

Date: 29/08/2014

Abstract

Small rings are frequently found in natural products as well as incorporated into drugs and agrochemicals in which they impart valuable properties on the biological activity of these compounds. Cyclopropanes are also extremely useful as reagents in organic synthesis, in particular as “umpolung” reagents, allowing access to products which would otherwise be more difficult to synthesise. This thesis will describe forays into the synthesis and further substitution of small rings as well as the iminium-catalysed ring-opening of cyclopropanes.

The introduction will outline the uses and properties of cyclopropanes, and will also describe some of the more common ways for incorporating cyclopropanes into larger structures. This will include the Horner–Wadsworth–Emmons procedure which has previously been developed by the group.

The second chapter describes efforts towards the iminium-catalysed nucleophilic ring-opening of cyclopropanes. This is followed by Chapter 3, in which the Horner–Wadsworth–Emmons methodology for the synthesis of the cyclopropanes used in Chapter 2 is investigated as a procedure for the synthesis of 4-membered heterocycles.

Chapter 4 describes the development of a decarboxylative method for the protodecarboxylation of cyclopropanecarboxylic acids. This was developed as the first step towards decarboxylative cross-coupling of cyclopropanes. Decarboxylative cross-couplings have been extensively developed as environmentally friendly and facile alternatives to the current cross-coupling methods. In Chapter 5 the attempted development of a decarboxylative cross-coupling reaction of cyclopropanes is described.

Conclusions and future work are outlined in Chapter 6, followed by the experimental details in Chapter 7.

Table of Contents

Abstract	3
Table of Contents	4
Acknowledgements	8
List of Abbreviations	9
Chapter 1 Introduction	11
1.1 Early research on cyclopropane	12
1.2 Electronic and bonding properties of small rings	14
1.2.1 Electronic and bonding properties of cyclopropanes	14
1.2.2 Bonding properties of four-membered rings	17
1.2.2.1 Cyclobutane	17
1.2.2.2 Heterocyclic four-membered rings	17
1.3 Synthetic strategies towards small rings	18
1.3.1 Synthetic strategies towards cyclopropanes	18
1.3.1.1 Cyclopropanes from carbenes and carbenoids – concerted mechanism	20
1.3.1.2 Cyclopropanes by a stepwise mechanism	21
1.3.2 Synthetic strategies towards four-membered rings	22
1.4 Uses of small rings	24
1.4.1 Uses of cyclopropanes	24
1.4.2 Uses of four-membered rings	25
1.5 Summary of the PhD	27
1.5.1 Initial intentions (Chapter 2)	27
1.5.2 Four-membered rings (Chapter 3)	27
1.5.3 Decarboxylative cross-coupling (Chapters 4 and 5)	28
Chapter 2 Nucleophilic Ring-Opening of Cyclopropanes	29

2.1 Background I	30
2.1.1 Wadsworth-Emmons synthesis of cyclopropanes	30
2.2 Results and Discussion I	38
2.2.1 Synthesis of cyclopropane substrates	38
2.2.1.1 Synthesis <i>via</i> the cyclopropyl ester	38
2.2.1.2 Synthesis <i>via</i> cyclopropyl nitriles	38
2.2.2 Investigation of the stereoselectivity of the reaction	40
2.2.2.1 Current proposed reaction pathway	41
2.2.2.2 Analysis of the solvent effect	42
2.2.2.3 Effect of the anion stabilising group and sterics	43
2.2.2.4 Effect of the temperature	44
2.3 Conclusions I	45
2.4 Background II	46
2.4.1 Nucleophilic ring-opening of cyclopropanes	46
2.4.2 Iminium ion driven organocatalysis	49
2.4.2.1 The role of water in iminium ion catalysed Michael addition	51
2.4.2.2 The effect of the counterion	52
2.4.2.3 The enantioselectivity of iminium ion catalysed Michael addition	52
2.4.3 Summary of the major points	57
2.5 Results and Discussion II	59
2.5.1 Initial attempts at ring-opening	59
2.5.2 Screening of reaction conditions	61
2.5.2.1 Heteroaromatic nucleophiles	61
2.5.2.2 ¹ H NMR analysis of heteroaromatic nucleophiles	65
2.5.2.3 Screening of anionic nucleophiles	66
2.5.3 Preforming the iminium ion	67
2.5.4 Conclusion of the project	70
2.6 Conclusions II	72
Chapter 3 Synthesis of Four-Membered Heterocycles	73

3.1 Background	74
3.2 Results and Discussion	77
3.2.1 Intermolecular route	77
3.2.1.1 Synthesis of starting materials from diethyl phosphite	77
3.2.1.2 Attempts to synthesise sulfur-containing phosphonates	78
3.2.1.3 Screening of conditions for intermolecular oxetane formation	79
3.2.2 Intramolecular route	81
3.2.2.1 Synthesis of starting material from diazophosphonates	81
3.2.2.2 Attempts to synthesise amine-substituted phosphonates	83
3.2.2.3 Screening of conditions for intramolecular oxetane formation	84
3.3 Conclusions	89
Chapter 4 Protodecarboxylations of Cyclopropanecarboxylic Acids	90
4.1 Background	91
4.1.1 Decarboxylation of cyclopropanecarboxylic acids	91
4.1.2 Thermal decarboxylations of arylcarboxylic acids	93
4.1.3 Copper-mediated decarboxylation of arylcarboxylic acids	93
4.1.3.1 The role and nature of copper in the reaction	93
4.1.3.2 The role of the solvent	95
4.1.3.3 Radical vs non-radical mechanism	95
4.1.3.4 The effect of substituents	96
4.1.4 Summary of major points	97
4.2 Results and Discussion	99
4.2.1 Synthesis of starting materials	99
4.2.2 Optimisation of the protodecarboxylation	101
4.2.3 Scope of the reaction	103
4.2.3.1 Screening of cyclopropanes	103
4.2.3.2 Non-heteroaromatic substrates	104
4.2.3.3 Heteroaromatic substrates	109

4.2.3.4	Influence of the substrate pK _a	111
4.2.3.5	Functionalisable substrates	112
4.2.3.6	Disubstituted cyclopropanes	113
4.2.4	Mechanistic studies	113
4.3	Conclusions and future work	115
Chapter 5	Cross-Couplings of Cyclopropanes via a Decarboxylative Process	116
5.1	Background	117
5.1.1	Decarboxylative cross-coupling reactions	117
5.1.2	Cross-coupling of cyclopropanes	121
5.1.2.1	Cyclopropanes as nucleophilic partners	121
5.1.2.2	Cyclopropanes as electrophilic partners	122
5.2	Results and discussion	126
5.2.1	Attempts at cross-coupling of cyclopropanecarboxylic acids	126
5.2.2	Initial attempts at cross-coupling of bromocyclopropane	126
5.2.3	Synthesis of (<i>trans</i>-2-iodocyclopropyl)benzene	128
5.2.4	Screening of (<i>trans</i>-2-iodocyclopropyl)benzene	129
5.2.5	Synthesis of (<i>E</i>)-(2-iodocyclopropyl)methoxy)methyl)benzene	131
5.2.6	Screening of (<i>E</i>)-(2-iodocyclopropyl)methoxy)methyl)benzene	133
5.3	Conclusions and future work	137
Chapter 6	Summary and Future Work	138
Chapter 7	Experimental Section	142

Acknowledgements

First of all I would like to thank my supervisor, Dr Chris Bray, for his support during my PhD and while I was writing my thesis. I would also like to thank the members of my panel, Prof. Marina Resmini and Dr Igor Larossa, for their help and advice, and QML for funding my PhD.

I have thoroughly enjoyed working with Fabry, Nicky, Harry, Geoff and, for the last few months, Nicolas, who were generous with their time and always ready to help out with any problems. In particular, Fabry was always ready to help and listen both in and out of the lab. Nicky, Geoff and Harry provided plenty of entertainment and Nicolas, although he only joined the group two months before I left, managed to answer a lot of questions while I was writing up, as well as providing good competition for tea-drinking.

I'd also particularly like to mention Eileen for too many reasons to list but, if I have to choose, the cake was always good; Freda, for always being ready to help no matter how much she had on her plate, Phil for all the coffee breaks, Sai for all the rants, Dolça for making demonstrating more bearable and Katrina for being a great housemate and the whole department for 'lending' me chemicals.

It has always been the other people in Joseph Priestley who made it possible to get through the long hours so I'd like to thank everyone in JP, including John H, Jay, Agha, Alan B, Jalal, Harold and Greg C for NMR, and John Cowley for glass repairs – I was responsible for a fair bit of that. Some of the academics also deserve a special mention so thanks also to Greg (the other one), Nathalie and Alice.

Finally, I'd like to thank my family, who have always been there for me since I moved over to London and have put up with long periods of no contact without complaint, although the "are you alive" message always worked. There are obviously too many things to list here so I will just say thanks for all of it – it was hugely appreciated.

List of Abbreviations

ARC	Anion relay chemistry
ASG	Anion-stabilising group
cpr	Cyclopropane/cyclopropyl
DIBALH	Diisobutylaluminium hydride
DMA	Dimethyl acetamide
DME	Ethylene glycol dimethyl ether
DMF	Dimethylformamide
EDG	Electron-donating group
EWG	Electron-withdrawing group
FG	Functional group
HMR	Homologous Michael reaction
HWE	Horner–Wadsworth–Emmons
L	Ligand
LDA	Lithium diisopropylamide
lit.	Literature
mol. sieves	Molecular sieves
NICS	Nucleus-independent chemical shift
NIS	<i>N</i> -Iodosuccinimide
NMP	<i>N</i> -Methyl pyrrolidinone
phen	1,10-Phenanthroline
PMB	<i>p</i> -Methoxybenzyl ether

RT	Room temperature
sat	Saturated
TBAB	Tetrabutylammonium bromide
TBAF	Tetrabutylammonium fluoride
TEMPO	2,2,6,6-Tetramethyl-1-piperidinyloxy
TEPA	Triethyl phosphonoacetate
TFA	Trifluoroacetic acid
THF	Tetrahydrofuran
WEC	Wadsworth–Emmons cyclopropanation

Chapter 1 *Introduction*

This introduction is intended to give a brief outline of the chemistry of small rings, including their unique bonding properties, synthetic strategies for their preparation and their uses in both synthetic chemistry and in a wider arena. This will give some basic information regarding small rings that will be referred to throughout the thesis. Further specific background information will be given at the beginning of each section.

This chapter also contains a summary of all projects and the reasons for the choice of each project.

1.1 Early research on cyclopropane

Given their inherent ring-strain (Fig. 1.1), cyclopropanes and four-membered rings have a unique reactivity. In particular, cyclopropanes react in ways that would be unexpected for alkanes, even when taking their ring-strain into consideration.





					
Bond angle:	109.5°	60°	90°	108°	120°
Ring strain (kcal mol⁻¹)	N/A	27.5	26.5	6.5	0

Fig. 1.1. Bond angles and strain energies in cycloalkanes

Cyclopropane was first synthesised in 1881 by Freund *via* the reaction of 1,3-dibromopropane with sodium (Scheme 1.1).¹ This discovery allowed access to cyclopropane and its derivatives, leading to much research, still ongoing, on this unique species.

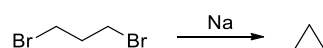

Scheme 1.1. First synthesis of cyclopropane

The three-membered carbocycle was initially named trimethylene but is now named cyclopropane in line with its acyclic analogue. The naming of carbocycles follows this trend (a four-carbon ring is cyclobutane; a five-carbon ring is cyclopentane) and can also be extended to the alkene analogues (cyclopropene,

cyclobutene etc.). The inclusion of a heteroatom gives oxirane (or epoxide) and oxetane, for oxygen-containing rings; aziridine and azetidine, containing nitrogen, with “az-” and “-ine” indicating the nitrogen atom and the amine structure; and thiirane and thietane, where the prefix “thi-” indicates the presence of sulfur (Fig. 1.2).

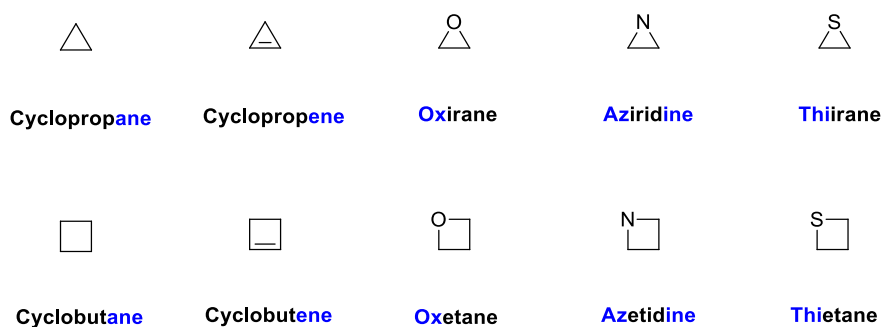

Fig. 1.2. Names of some three- and four- membered rings

Although early researchers widely agreed that the cyclopropane structure was a three-membered ring, they were struck by its alkene-like reactivity. Although it was found to be inert to oxidation by potassium permanganate, cyclopropane underwent other conversions, such as addition reactions and reduction by nickel, in the same way as alkenes. For these reactions to occur it was necessary to cleave the ring and cyclopropane was therefore deemed to be quite unstable. However, further research showed that cyclopropane would only isomerise to propene at 400 °C, unless in the presence of finely divided platinum or zinc chloride, with which it could isomerise at 100 °C and ambient temperatures respectively.^{1b} This, along with the existence of compounds such as U-106305 (Fig. 1.3), an oligocyclopropane, indicates that the cyclopropane ring is, in fact, relatively stable, demonstrating that the bonding and electronic properties of cyclopropanes are more complicated than would have been expected.

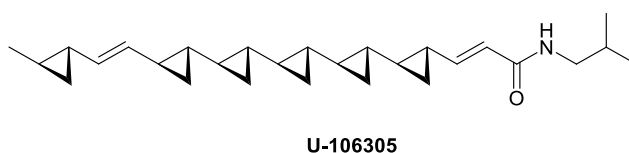

Fig. 1.3. Biologically active oligocyclopropane U-106305

1.2 Electronic and bonding properties of small rings

1.2.1 Electronic and bonding properties of cyclopropanes

The electronic and bonding properties of cyclopropanes have thus generated much interest and research. The bond angle of 60° , 49.5° less than the angle adopted by unconstrained alkanes, imparts a strong Baeyer (angular) strain. There is also some Pitzer (torsional) strain which is caused by the eclipsed arrangement of the C–H bonds. The opening of the ring relieves this strain and provides a thermodynamic driving force for many of the reactions of cyclopropanes.

Strain is not, however, the only factor that contributes to the reactivity of cyclopropanes. Cyclopropanes have a strain energy of $27.5 \text{ kcal mol}^{-1}$, just $1.0 \text{ kcal mol}^{-1}$ more than cyclobutane ($26.5 \text{ kcal mol}^{-1}$), despite the much lower Baeyer strain in the latter compound. However, cyclopropanes and cyclobutanes do not have the same reaction profile, with cyclobutanes undergoing predictable ring-cleavage reactions to give ring-opened, ring-expanded or ring-contracted products. Cyclobutane occasionally acts as an electrophile² but does so less readily than cyclopropanes.

The comparably lower than expected ring-strain, as well as other unusual properties of cyclopropanes, such as the downfield shift of their protons in the ^1H NMR spectra, was largely ignored for many years, as chemists were unable to form a hypothesis to explain it.

There are now several models to describe the bonding in cyclopropane. One of these is the Coulson–Moffitt Model, which describes the CH_2 groups as sp^3 -hybridised moieties (Fig. 1.4).³ This gives a C–C bond which is directed approximately 22° outwards from a straight bond – the bonds are thus “bent” and have 20% less effective overlap than the C–C bond in ethane, which would justify the ring strain. The bent bonds also explain the shorter intercarbon distance in cyclopropanes as, although the arc formed by the overlapping sp^3 orbitals is not shorter, the carbon atoms would be closer in space to one another. Another form of the Coulson–Moffitt model denotes the C–H bonds as $\text{sp}^{2.3}$ and the C–C bonds as sp^5 . In this case, the greater p-character in the C–C bond would rationalise the alkene-like chemistry of cyclopropanes, while the greater s-character of the C–H

bonds would be the reason for their increased strength as s-orbitals are lower in energy and thus the greater s-orbital contribution would impart added stability.

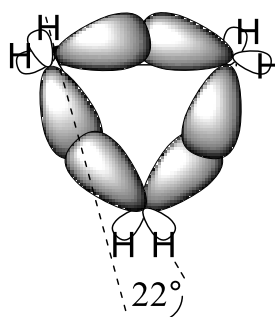

Fig. 1.4. The Coulson–Moffitt Model

A second model is the Walsh Model (Fig. 1.5).⁴ This attributes sp^2 -hybridisation to the CH_2 groups and again concludes that poor orbital overlap is the contributing factor to the reactivity of the cyclopropane ring. In this case the sp^2 orbitals are arranged so that they are pointing into the centre of the cyclopropane ring. There are three bases for this model. Ψ_1 shows low overlap because the orbitals are oriented inwards and Ψ_2 shows a π -like bond that is distorted, giving poor overlap. This π -character would explain the susceptibility of cyclopropanes to electrophilic attack.

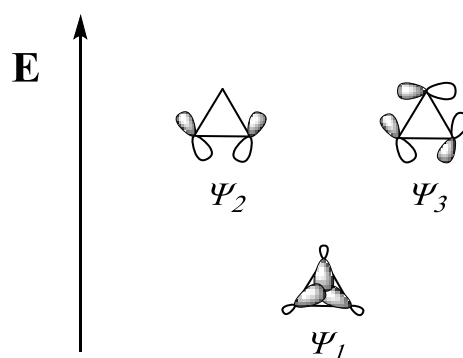

Fig. 1.5. The Walsh Model

Another approach is to view the molecule as σ -aromatic as proposed by Dewar.⁵ This can be deduced from the $4n + 2$ rule of aromaticity, as the three C–C bonds provide a ring of 6 electrons. σ -Aromaticity would explain several properties of cyclopropanes, some of which are outlined below:

- a) The strain energy of cyclopropane is $27.5 \text{ kcal mol}^{-1}$,⁵ which is much lower than the value of $104 \text{ kcal mol}^{-1}$ calculated from the C–C–C bending force constant used in vibration spectroscopy.
- b) The upfield shift of the C–H protons in the $^1\text{H-NMR}$ can be explained by shielding due to ring-current effects (Fig. 1.6).
- c) Cyclopropane C–C distances (1.51 \AA) are shorter than those of straight chain alkanes (1.53 \AA), contrary to the usual effect of ring strain, which weakens and lengthens bonds. This can be explained by aromatic stabilisation, which strengthens these bonds.
- d) During electrophilic attack the aromaticity would be maintained in the transition state which would account for the high reactivity.

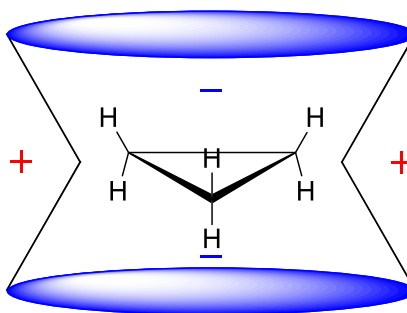

Fig. 1.6. Magnetic field of cyclopropanes

Since this, although the concept of σ -aromaticity is widely accepted and has been extended to other three-membered rings,⁶ its application to cyclopropanes has been a subject of some debate, with wide-ranging values being deduced for the σ -aromatic stabilisation – *e.g.* 3.5 ,⁷ 11.3 ⁸ and 48 ⁹ kcal mol^{-1} . However, the σ -aromatic ring current theory (Fig. 1.6) has been generally accepted and supported by further evidence, including a negative nucleus-independent chemical shift (NICS) of -8.9 ppm . In contrast, the relative instability of cyclobutane is explained by σ -antiaromaticity with an NICS value of $+1.2 \text{ ppm}$. For reference, that of benzene is -10.2 ppm .⁷

While the concept of σ -aromaticity in cyclopropanes is, therefore, somewhat controversial,¹⁰ the bonding models depicted above (*i.e.* the Coulson–Moffitt and Walsh models) are widely accepted and cyclopropane is considered to behave akin to a compound containing sp^2 -hybridised centres, and to have shortened C–C distances with bent bonds.

1.2.2 Bonding properties of four-membered rings

1.2.2.1 Cyclobutane

Due to their unremarkable reactivity, there has not been as much research on the bonding of cyclobutanes and other four-membered rings, except in relation to that of cyclopropanes. As mentioned, cyclobutanes have a similar ring-strain to cyclopropanes and do not appear to benefit from the same stabilising effects that have been described for cyclopropane – *i.e.* although the Baeyer ring-strain in cyclobutanes is similar to that of cyclopropanes, this is not counteracted by other factors. Cyclobutanes and cyclopropanes suffer approximately similar degrees of Pitzer strain due to the inability of the C–H bonds to adopt a less eclipsed conformation. However, in cyclobutanes this strain can be reduced by puckering of the ring. The cyclobutane moiety also contains bent bonds as well as an increased s-character in its C–H bonds.¹¹ Again, the concept of σ -antiaromaticity in cyclobutane, explaining the downfield shift of its ¹H NMR signals, is a subject of some dispute, with some research claiming that antiaromaticity causes the deshielded signals in the ¹H NMR,⁶ while other research claims that there is no evidence that this is the case.¹²

1.2.2.2 Heterocyclic four-membered rings

Cyclobutanes, azetidines and thietanes naturally adopt a puckered conformation, reducing their Pitzer strain, while oxetanes adopt a planar conformation (Fig. 1.7).¹³ A much higher energy is required for inversion of the puckered conformation in most four-membered rings (3.74×10^{-4} kJ mol⁻¹ for cyclobutane; 3.69×10^{-4} kJ mol⁻¹ for azetidine; 2.29×10^{-4} kJ mol⁻¹ for thietane) than is required in oxetane ($1.279 \pm 0.041 \times 10^{-3}$ or 2.926 ± 0.418^{-3} kJ mol⁻¹).¹⁴ It can be presumed that the lower barriers for both thietanes and oxetane are due to the absence of a substituent which would result in eclipsing interactions with the other protons on the ring in the planar form. Sulfur's larger electron distribution into its d-orbitals could explain the larger energy requirement for the inversion of thietane compared to oxetane. The longer C–S bond distance compared to that of C–O would also enlarge the bond angle at the carbon opposite to the sulfur atom for thietane.

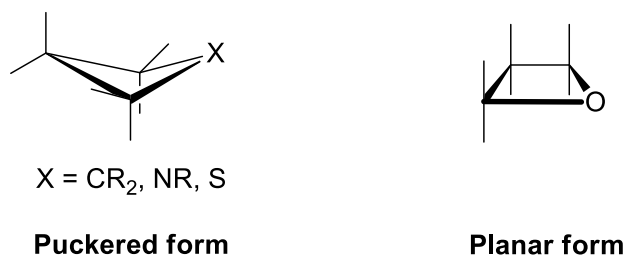

Fig. 1.7. Puckerred and planar four-membered rings

The planar conformation of oxetane is thought to occur as a result of torsional and angular strain. Ring-puckerred can be predicted by taking these factors into account.¹⁴

1.3 Synthetic strategies towards small rings

Due to their inherent ring strain, the formation of small rings is energetically unfavourable in comparison to larger five- and six- membered rings, which are relatively easy to form. However, there are general strategies that can be used for the synthesis of three- and four- membered rings.

1.3.1 Synthetic strategies towards cyclopropanes

Incidentally, Perkin, while working for Baeyer (who initially put forward the theory of ring-strain), synthesised the first cyclopropane derivative in 1884.¹⁵ This was achieved *via* a method that is now named the “Perkin synthesis” (Scheme 1.2).

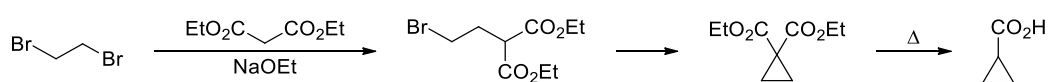

Scheme 1.2. Perkin synthesis of the first cyclopropane derivative

The next major step forward in the synthesis of cyclopropanes was by Doering and Hoffman, who generated dichlorocarbene from chloroform, which then reacted with alkenes for the formation of cyclopropanes.¹⁶ The reaction will also proceed using bromoform and iodoform (Scheme 1.3). This laid the groundwork for what is now one of the most common methods for cyclopropane formation, the Simmons–Smith reaction, developed in 1958,¹⁷ which makes use of a zinc carbenoid intermediate (see Section 1.3.1.1, p. 20).

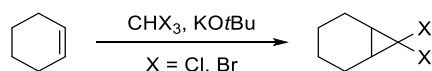

Scheme 1.3. Doering and Hoffmann's carbene synthesis of cyclopropanes

Further headway was made in 1961, when Stork and Ficini developed the first synthesis of cyclopropanes using a diazoalkane and alkenes in the presence of copper bronze, as an alternative to the organozinc required for the Simmons–Smith method (Scheme 1.4).¹⁸

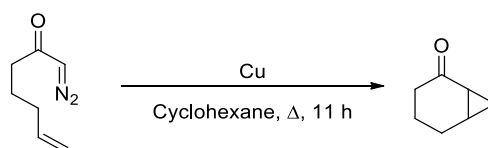

Scheme 1.4. First synthesis of cyclopropane using a diazoalkane

In the same year, the Corey–Chaykovsky synthesis of cyclopropanes, epoxides and aziridines was also published.¹⁹ This makes use of a sulfur ylide and follows a stepwise mechanism for the formation of the cyclopropane (Scheme 1.5).

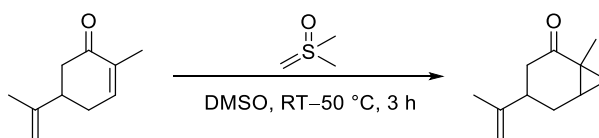

Scheme 1.5. First synthesis of cyclopropanes using a sulfoxonium ylide

These reactions represent the two major strategies to cyclopropanes, which are concerted and stepwise syntheses. Scheme 1.6 shows a representation of the mechanism of each of these reactions.

For concerted cyclopropane formation, the two bonds are formed simultaneously through the use of a donor–acceptor moiety, which is stabilised by an anion-stabilising group (ASG).

The stepwise mechanism requires the generation of a negative charge, again stabilised by an ASG, which nucleophilically attacks the electrophile (in intramolecular cases, this first step has essentially already taken place). This negative charge is displaced into an EWG on the electrophile. The negative charge then moves back through the system to attack the original nucleophile, which loses a leaving group.

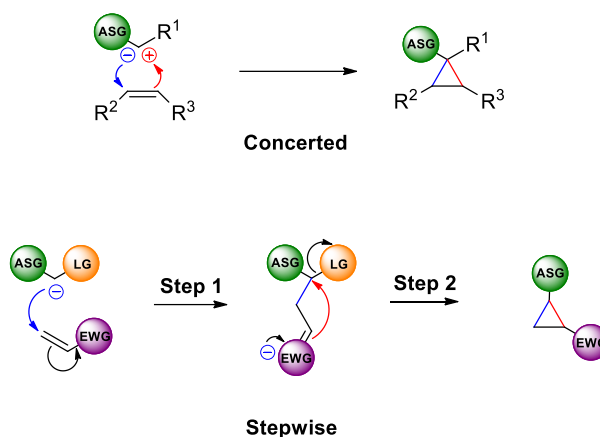

Scheme 1.6. Depiction of strategies for the synthesis of cyclopropanes

Reported examples of each of these strategies are shown below.

1.3.1.1 Cyclopropanes from carbenes and carbenoids – concerted mechanism

As mentioned above, one of the best-known concerted methods for the formation of cyclopropanes is the Simmons–Smith¹⁷ reaction (A,²⁰ Scheme 1.7). This relies on the concerted formation of two carbon bonds from an alkene and a carbenoid molecule, usually generated from diethyl zinc. The reaction tolerates several functional groups and proceeds with retention of stereochemistry due to its concerted mechanism, enabling a stereoselective reaction. This type of reaction was originally achieved using a Zn/Cu couple, but this is an unreliable method due to the variation in the quality of the Zn/Cu couple, which is difficult to generate with consistent reactivity.

Another synthesis that makes use of this type of strategy is the formation of cyclopropanes from diazo compounds, which, upon activation by a metal catalyst, release nitrogen to generate the carbenoid (B,²¹ Scheme 1.7). This can also be achieved in some instances by simple deprotonation to form the nucleophilic carbon, which can then attack the alkene (C,²² Scheme 1.7). These reactions require the presence of EWGs adjacent to the carbenoid in order to allow the reaction to occur and are thus limited in their use. They also have a reduced level of stereoselectivity when compared to the Simmons–Smith method.

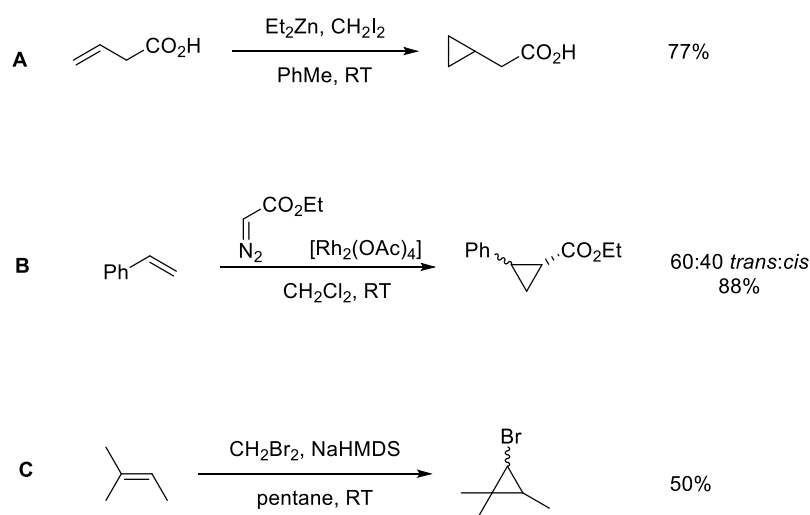

Scheme 1.7. Concerted strategies towards cyclopropanes *via* carbenes and carbenoids

1.3.1.2 Cyclopropanes by a stepwise mechanism

The Corey–Chaykovsky method involves the generation of a carbon nucleophile that is stabilised by the presence of a positively charged sulfur atom in the α -position (*i.e.* a sulfur ylide species is used).¹⁹ The carbon nucleophile adds to an alkene through Michael addition to form the cyclopropane by the stepwise formation of two carbon bonds (A,²³ Scheme 1.8). This reaction requires the presence of a conjugated electron-accepting group on the alkene, limiting its scope.

Another method for the synthesis of cyclopropanes is the Wadsworth–Emmons cyclopropanation reaction, which utilises phosphonates and epoxides and again proceeds through the stepwise formation of the two carbon bonds (B,²⁴ Scheme 1.8).²⁵ This reaction is stereospecific and predominantly *trans*-selective and can give high levels of enantioselectivity. However, it also requires the presence of ASGs on the phosphonate. An in-depth discussion of this reaction will be given later (Section 2.1, p. 30).

One further method is the S_N2 displacement reaction, which involves the stepwise generation of the cyclopropane through a deprotonation–alkylation sequence (C,²⁶ Scheme 1.8). The presence of at least one EWG to reduce the pK_a of the site of deprotonation is required. This reaction gives variable yields and can result in a number of side-products.

These reactions comprise the common strategies to cyclopropanes. An in-depth review on stereoselective cyclopropanation reactions covers the above reactions, excluding the stepwise dialkylation procedure (C, Scheme 1.8), as well as miscellaneous others.²⁷

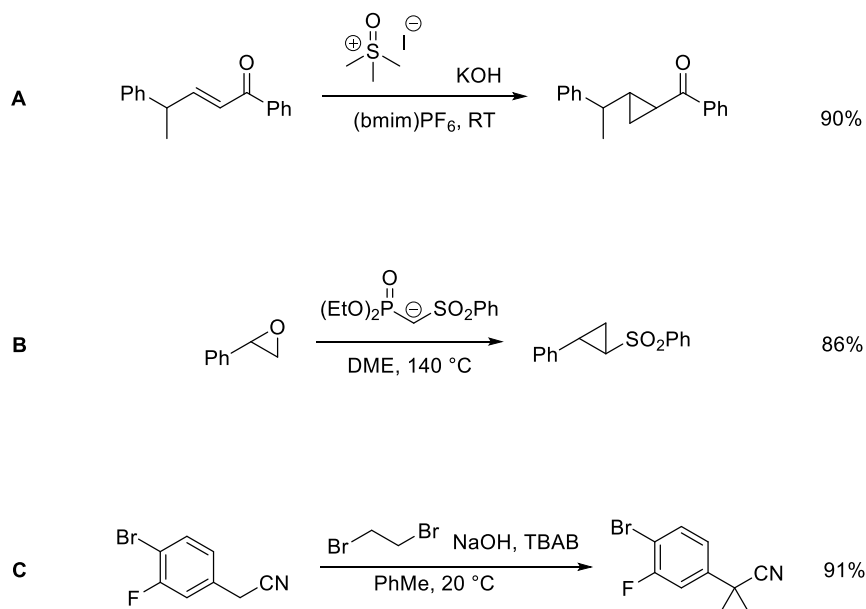

Scheme 1.8. Stepwise strategies to cyclopropanes

1.3.2 Synthetic strategies towards four-membered rings

The most common route towards four-membered rings is cyclisation by nucleophilic displacement, where the nucleophile can be either a carbanion or a heteroatom (A,²⁸ Scheme 1.9), such as loss of a halide leaving group, ring-opening of three-membered rings or loss of a group generated during the reaction.

An example of the latter case is the use of sulfoxonium intermediates (usually dimethyl sulfoxonium) in the same manner as the Corey–Chaykovsky cyclopropanation reaction (B,²⁹ Scheme 1.9). The nucleophilic displacement can also be an intermolecular reaction (C,³⁰ Scheme 1.9). Loss of HX during these reactions leads to a competition between nucleophilic attack on this moiety and nucleophilic attack for cyclisation, the latter of which would be less favoured due to the strained ring being formed. There can also be competition for the formation of three-membered rings if the substrate can be deprotonated at the wrong position.

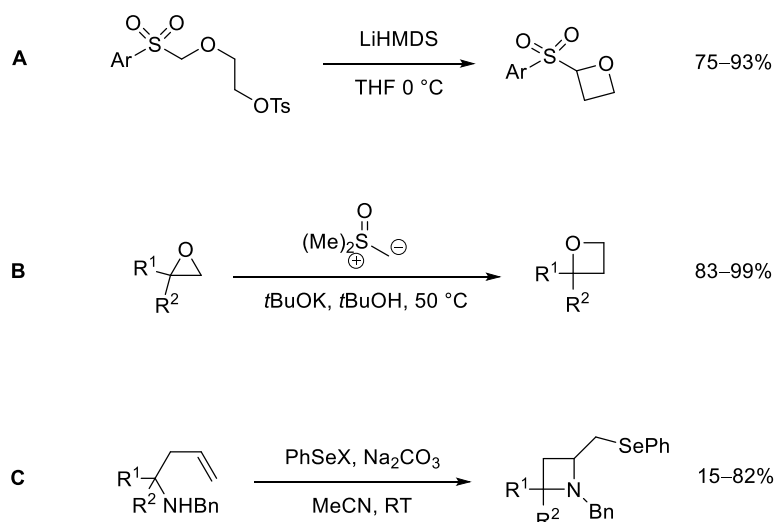

Scheme 1.9. Synthesis of four-membered rings by nucleophilic displacement

Cycloadditions are another common method for the formation of four-membered rings. An example of this is the Paternò–Büchi reaction for the formation of oxetanes (A,³¹ Scheme 1.10). However, in this case, control of facial selectivity is difficult to achieve.

Photochemical cyclisations (Yang cyclisation) can be used (B,³² Scheme 1.10) for C–C bond formation, as can ring contractions (C,³³ Scheme 1.10). However, photochemical cyclisations can suffer from side-reactions in the form of Norrish cleavage.

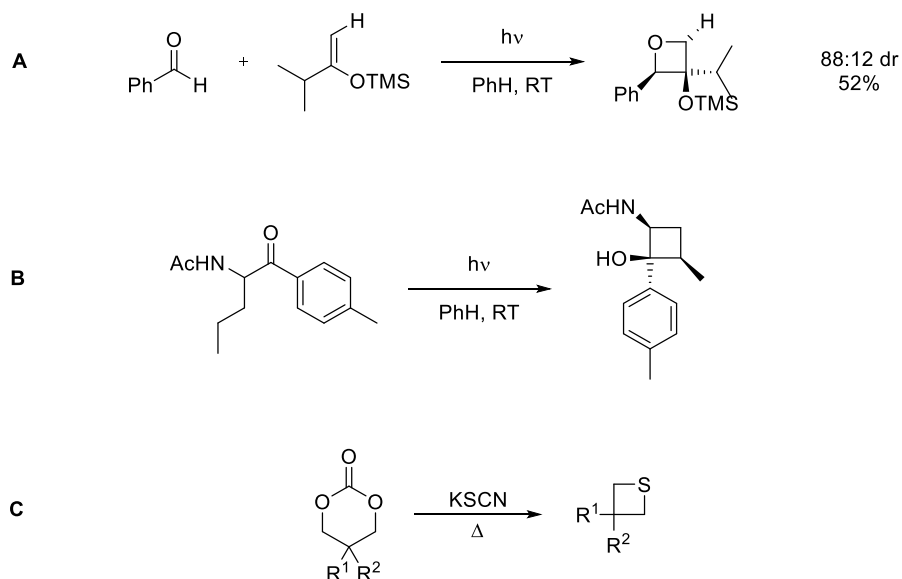

Scheme 1.10. Miscellaneous strategies to four-membered rings

1.4 Uses of small rings

1.4.1 Uses of cyclopropanes

Cyclopropanes are the smallest of the cyclic alkanes, a property that gives them unique characteristics and makes them extremely valuable to chemists. They are frequently found in natural products and in biologically active compounds (Fig. 1.8)³⁴ where they can provide a rigid structure, or take part in specific interactions or the chemical reaction that exerts the biological effect.³⁵

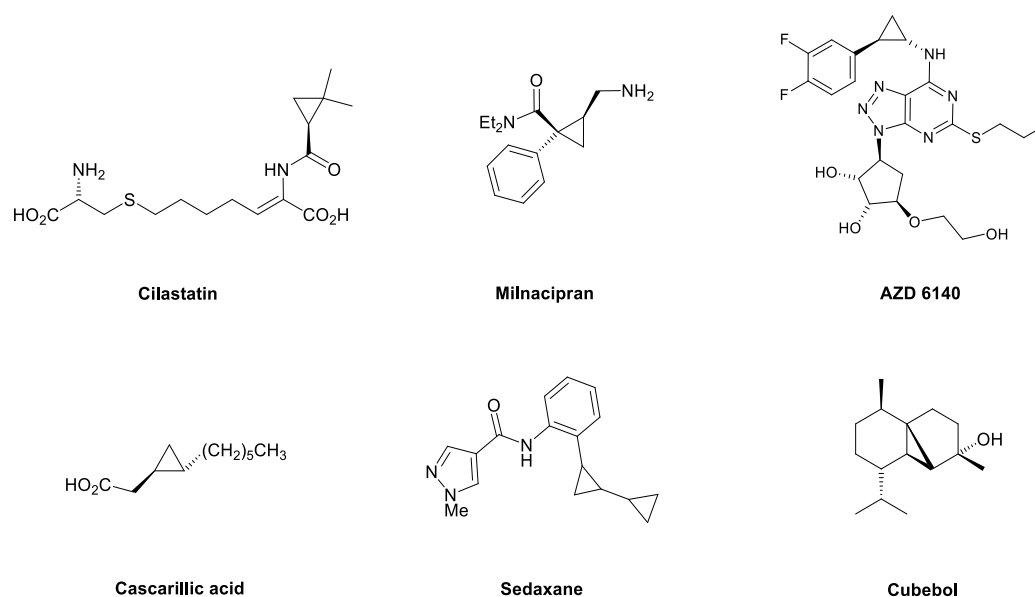
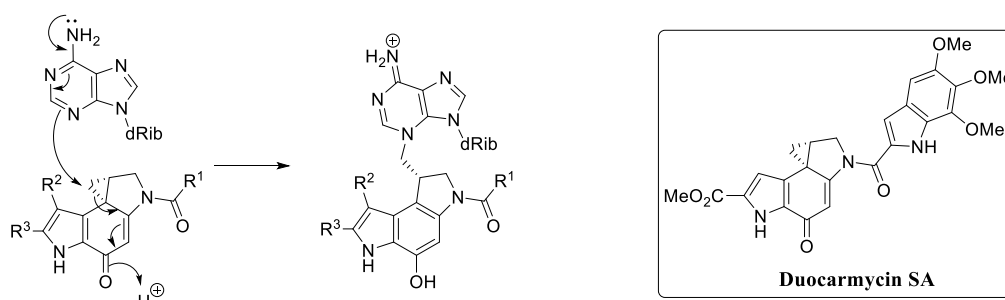

Fig. 1.8. Biologically active compounds containing cyclopropanes

For example, the duocarmycins are a family of natural products with antitumor properties that act by nucleophilic attack of the N9 of adenine on their cyclopropane ring, leading to alkylation on DNA (Scheme 1.11).³⁶



Scheme 1.11. Mode of action of the duocarmycins

This reaction also demonstrates a property of cyclopropanes that is useful to synthetic chemists. Due to their electronics, cyclopropanes react much like alkenes, undergoing oxidation reactions, electrophilic attack and addition reactions. This essentially allows them to be used as “umpolung” reagents in place of alkenes, giving access to products, displaced by one carbon, that might otherwise be difficult to access. For example, the hydrolysis of the alkene would give the conjugated product **1** (Scheme 1.12) while that of the cyclopropane gives the non-conjugated ketoalkene **2**, in which the distribution of charge can be set by further reactions or by substituents on the compound.

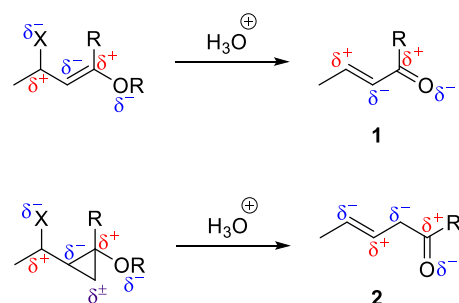

Scheme 1.12. “Umpolung” reactivity of cyclopropanes

Cyclopropanes are also useful in the pharmaceutical industry for the synthesis of drug analogues with added rigidity at the cyclopropane site, for specific interactions in the active site of the target or for probing the active site.³⁷

1.4.2 Uses of four-membered rings

Four-membered rings are also frequently found in natural products and biologically active compounds (Fig. 1.9).³⁸

In addition to cyclobutanes, four-membered heterocycles are extremely valuable in the pharmaceutical industry, in which they can be used in place of their larger-ring counterparts, as *gem*-dimethyl equivalents or as carbon–heteroatom double bond equivalents for the modulation of properties such as the lipophilicity, steric bulk, metabolic stability, solubility, conformation and basicity of drugs (Fig. 1.10).³⁹

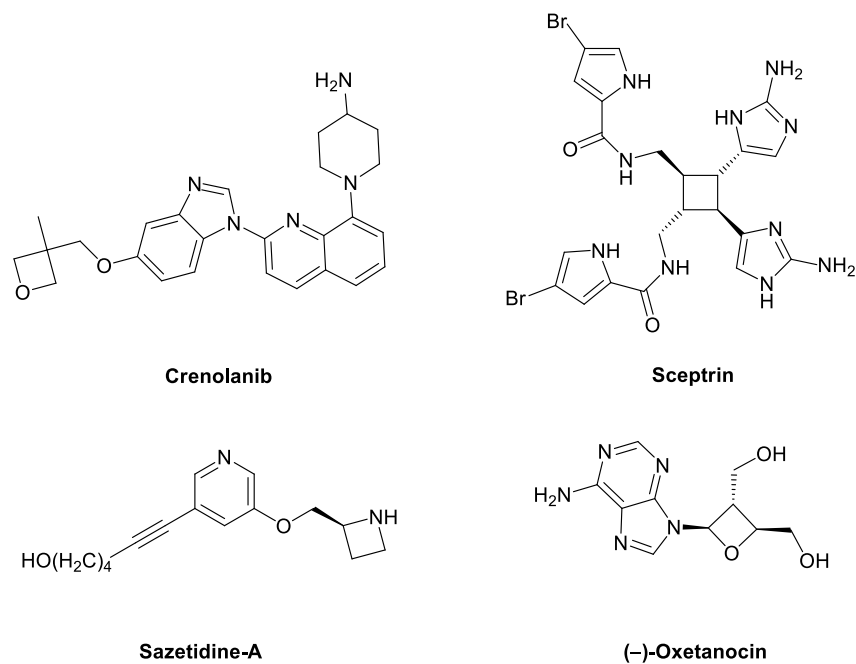

Fig. 1.9. Biologically active compounds containing four-membered rings

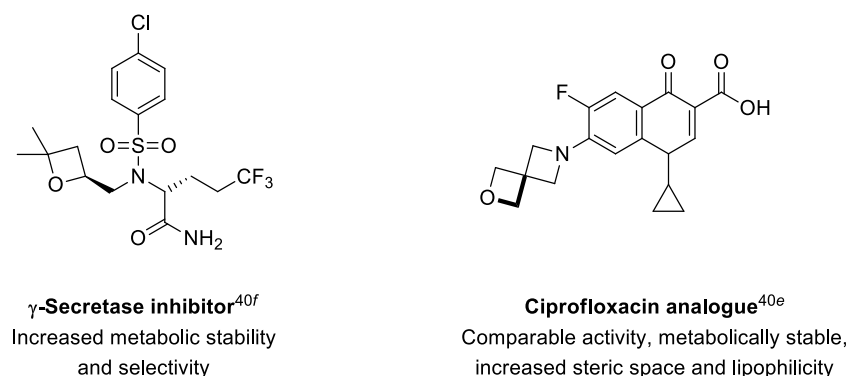
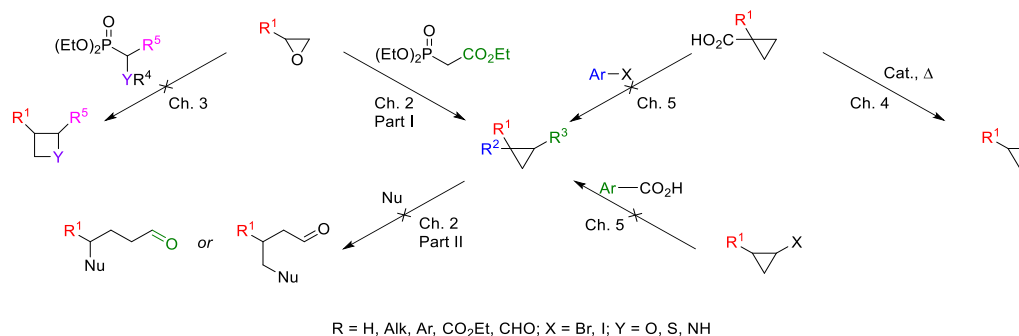

Fig. 1.10. Examples of the effect of four-membered heterocycles in drugs

Four-membered heterocycles are also useful as reactive intermediates in synthetic chemistry.⁴⁰ For example, they can act as analogues of their carbon–heteroatom double bond equivalents, providing products with two extra carbons attached to the heteroatom.

1.5 Summary of the PhD



Scheme 1.13. Depiction of each chapter in the thesis

1.5.1 Initial intentions (Chapter 2)

Scheme 1.13 depicts the areas covered in each chapter of the thesis. Initially, the aim of the PhD was to develop an organocatalysed nucleophilic ring-opening of cyclopropyl aldehydes. This project was based on the concept that the aldehyde would be converted to an iminium ion, which would draw electron density out of the cyclopropane ring, making it more susceptible to nucleophilic attack. Chapter 2 also includes details on the synthesis of the starting materials *via* the Wadsworth–Emmons cyclopropanation and describes a short investigation on the *cis/trans* selectivity of this reaction, as an unexpectedly high proportion *cis*-product being formed for some reactions.

Unfortunately, just under one year into the project, as some initial progress was being made in the development of the ring-opening reaction, the group of Gilmour in ETH published their work in this area, in which they achieved the reaction that we were aiming for.⁴¹ Given that there was little scope for any novel additions to the reaction, we elected to change the project.

1.5.2 Four-membered rings (Chapter 3)

The next project was based on the Wadsworth–Emmons reaction, which had been used for the synthesis of the cyclopropanes. However, we aimed to extend this methodology for the synthesis of four-membered rings by altering the phosphonate group. To do this we appended a heteroatom moiety to the α -carbon, which would potentially result in the formation of oxetanes, azetidines and thietanes. However, after four months of screening, with no promising evidence

found, it was decided that significant progress was unlikely in this area and that we should move on to another area.

1.5.3 Decarboxylative cross-coupling (Chapters 4 and 5)

We next turned our attention to the development of a method that would enable functionalisation of the cyclopropane ring to give more complex products akin to those found in biologically active compounds. Given the significant interest in decarboxylative cross-coupling reactions as environmentally friendly alternatives to the classical cross-coupling methods we hypothesised that cyclopropanes could be suitable substrates for this process, taking into account their sp^2 -character and possible aromatic character. Cyclopropanes have been successfully cross-coupled by various methods which were initially developed for aromatic and alkene substrates (see Section 5.1.2, p. 120), encouraging us to embark down this path.

Initially, we first developed a novel metal-catalysed decarboxylative cross-coupling reaction, which, to our surprise, had not previously been documented (Chapter 4). Following this, initial forays were made into the development of the cross-coupling reaction (Chapter 5).

Chapter 2 *Nucleophilic*
Ring-Opening of Cyclopropanes

The initial hypothesis by Denney and Boskin regarding the mechanism of the homologous Wittig reaction was that the first step was a nucleophilic attack of a phosphorane on styrene oxide to give zwitterion **3**, which is in equilibrium with a five-coordinate cyclic phosphorus species **4** (Scheme 2.1).²⁵

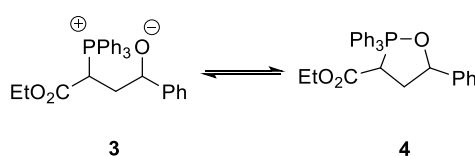

Scheme 2.1. Equilibrium proposed by Denney and Boskin

Following this publication, Wadsworth and Emmons published similar work utilising phosphonates, in which they investigated their reaction with epoxides.⁴³ They were able to convert the epoxides to cyclopropanes with wider scope, increased yield and drastically lowered temperatures (Scheme 2.2; Route a, Denney and Boskin; Route b, Wadsworth and Emmons).

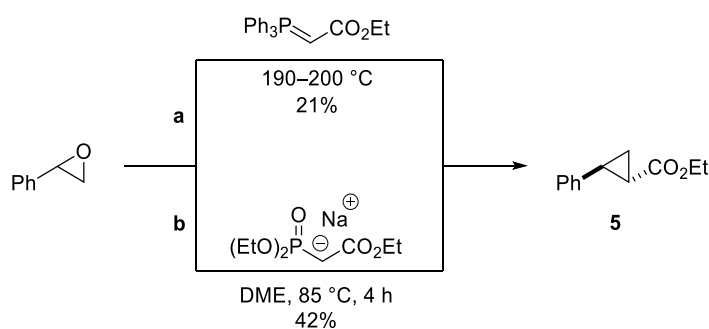

Scheme 2.2. Syntheses of **5** by (a) Denney and Boskin and (b) Wadsworth and Emmons

In this paper, it was deduced that the phosphonate must contain an electron-withdrawing group (EWG) for activation of the phosphonate, as the reaction of diethyl benzylphosphate did not afford a cyclopropane. Their proposed mechanism proceeded through the same type of intermediate **6**, as suggested by Denney and Boskin, followed by P–C bond cleavage to form a second intermediate **7**, whose anion is stabilised by the activating group. Finally 3-*exo-tet* cyclization afforded cyclopropane **5** (Scheme 2.3).

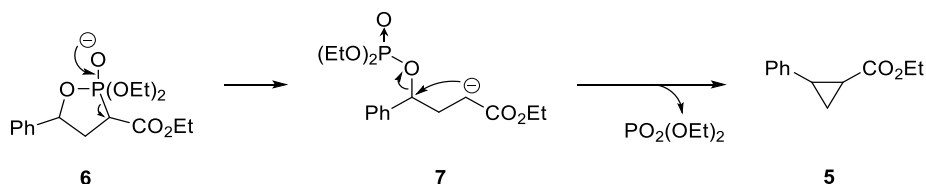

Scheme 2.3. Mechanism proposed by Wadsworth and Emmons for cyclopropane formation

It was also noted by Wadsworth and Emmons⁴³ that the *trans* isomer alone was formed, which was attributed to conversion of the kinetically favoured *cis* product to the thermodynamically favoured *trans* product. However, this was later shown to be inaccurate – *i.e.* the kinetically favoured intermediate leads to the *cis* product, but the betaine is shown to decompose in a stepwise manner, allowing conversion to the thermodynamically favoured *trans* isomer at these intermediate points. This will be discussed below.

Further investigation of the reaction of phosphoranes with epoxides was carried out by Denney *et al.*, providing more insight into the mechanism of the reaction (Scheme 2.4).⁴⁴ In this case they proposed a similar reaction route to Wadsworth and Emmons.

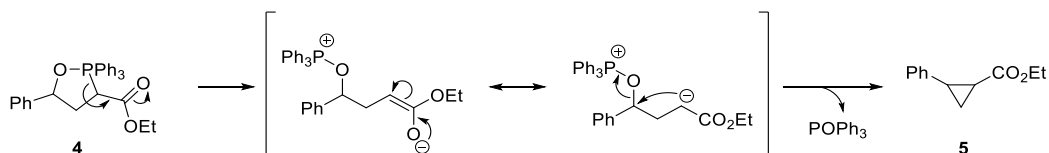

Scheme 2.4. Expanded mechanism proposal by Denney *et al.*

This mechanism predicts conservation of optical activity, which was confirmed by the reaction of (*S*)-(-)-styrene oxide to give optically active ethyl *trans*-2-phenylcyclopropanecarboxylate. It was also found that no reaction occurred when using triphenylbenzoylmethylenephosphorane, which was attributed to the lower nucleophilicity of this phosphorane for initial attack on the epoxide.

The above mechanism was further supported in publications by McEwen *et al.*⁴⁵ In the second of these back-to-back publications,^{45a} the authors used optically active methylethylphenylbenzylphosphonium iodide in reaction with styrene oxide to investigate the stereochemistry of the reaction at the phosphorus atom. Their results showed a 50% net inversion at phosphorus during the reaction to

form phosphine oxide. The authors cite the possible formation of several intermediates which they state coincides with Denney's mechanism.⁴⁴

In the first of these publications,^{45b} McEwen *et al.* examined the reaction of methylethylphenylbenzylidenephosphorane and styrene oxide to form **8** *via* intermediate **9** (Scheme 2.5).

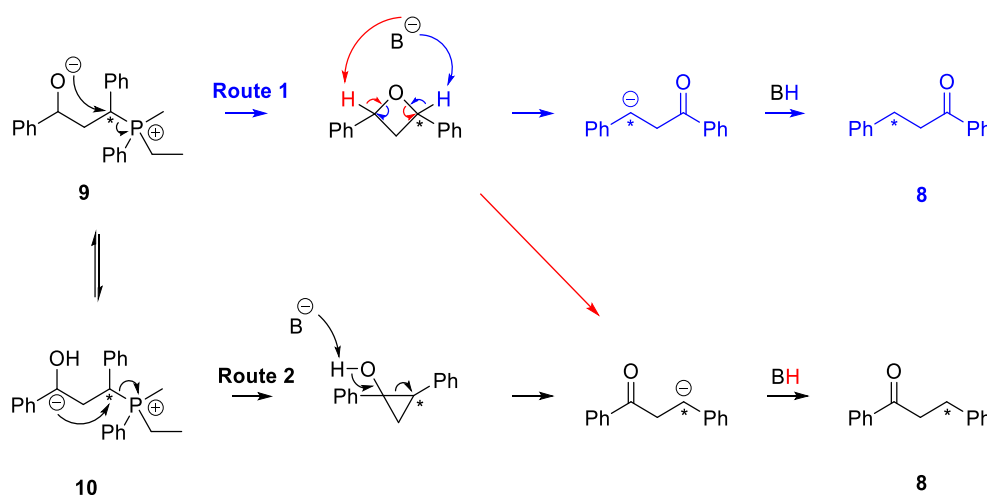

Scheme 2.5. Possible routes to **8**

They proposed two routes after the initial nucleophilic attack on the epoxide, *via* either nucleophilic attack by oxyanion **9** or carbanion **10**. The latter of these routes would proceed *via* the cyclopropanation reaction. To investigate which route was favoured, a ^{14}C label was installed in the α -position to the phosphonium ion, as indicated by the asterisk (Scheme 2.5). The product contained 100% of the ^{14}C label on the benzylic carbon, indicating that Route 2 was the sole route. If the reaction proceeded *via* Route 1 there would also have been some product with a ^{14}C label on the carbonylic carbon. These results corroborate the formation of a carbanion in this type of reaction.

Thus far, the publications discussed all suggest a stepwise decomposition of the cyclic intermediate (*e.g.* **4**, Scheme 2.4, p. 32). However, several authors have also suggested a concerted collapse of the intermediate, or formation of a zwitterionic intermediate (Scheme 2.6).⁴⁶ As can be seen from Scheme 2.6, a concerted collapse would lead to retention of configuration, while the formation of a zwitterionic intermediate could potentially allow rotation around the bonds, leading to a mixture of diastereomers. The formation of these intermediates could

explain the low optical yield obtained in the work performed by Denney⁴⁴ and Inouye *et al.*^{46b} as partial formation of these products would give the opposite optical rotation.

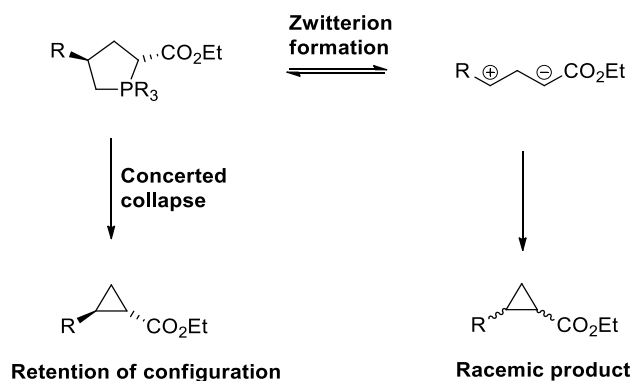

Scheme 2.6. Products from concerted collapse of cyclic intermediate and formation of zwitterion

In order to clarify the mechanism, Izydore and Ghirardelli performed some experiments using triethyl phosphonoacetate in reaction with optically active (+)-(2*R*,3*R*)-**11** and with racemic *cis*-**11** (Scheme 2.7).⁴⁷ Using (+)-(2*R*,3*R*)-**11**, Route 1 would produce the (+)-*trans* product, while Route 2 would produce the *cis,trans* and *cis,cis* products (Fig. 2.1). With (±)-*cis*-**11**, Route 1 would give the *cis,trans* and *cis,cis* products, while Route 2 would lead to the (±)-*trans* product.

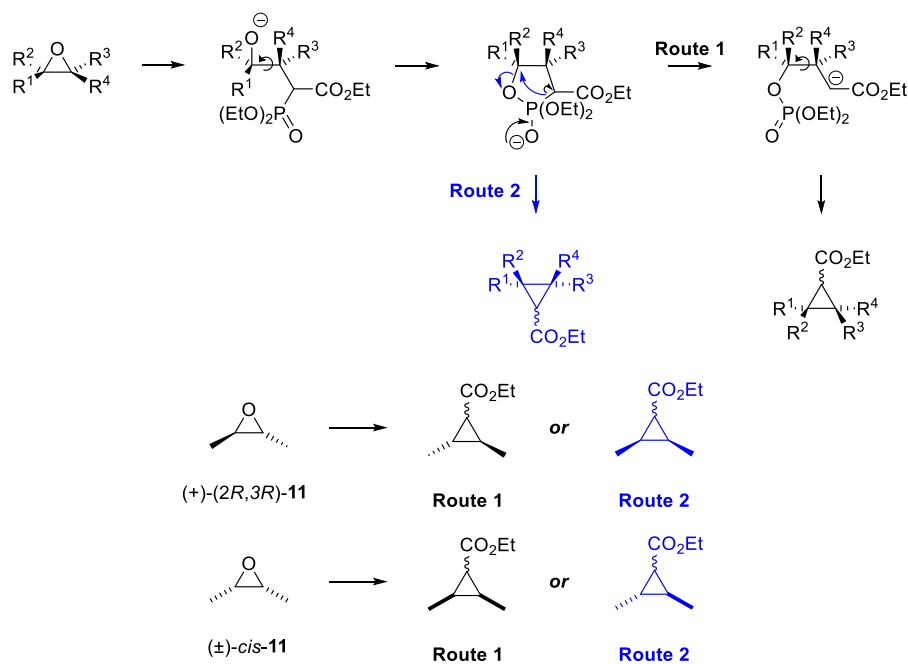

Scheme 2.7. Route investigated by Izydore and Ghirardelli

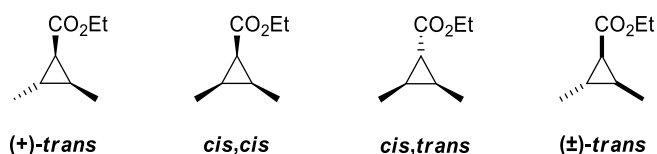
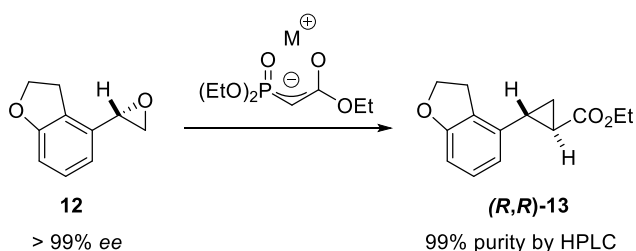

Fig. 2.1. Products of reaction investigated by Izydore and Ghirardelli

The product ratios showed that (+)-(2*R*,3*R*)-**11** gave 93% of the (+)-*trans* product (Route 1) and 6% and 1% respectively of the *cis,cis* and *cis,trans* products (Route 2), while (±)-*cis*-**11** gave 6% and 90% respectively of the *cis,cis* and *cis,trans* products (Route 1) and only 4% of the (±)-*trans* product (Route 2). These results indicate that, although there is some evidence of direct collapse of the cyclic intermediate, the predominant route follows the stepwise decomposition route proposed by Denney and supported by the subsequent work discussed thus far.^{42–47}

The works described thus far all investigated the mechanism by optical rotation. The first demonstration that enantiomerically pure starting material would give effectively complete inversion of stereochemistry at the epoxide centre was shown in reports by Armstrong and Scutt^{42h} and Singh *et al.*^{42g} The former authors demonstrated that enantiomerically pure (*R*)-styrene oxide could be converted to (*S,S*)-*trans*-2-phenylcyclopropanecarboxylate with greater than 95% *ee*. Similar results were found by Singh *et al.* (Scheme 2.8).^{42g} This corroborates a non-concerted mechanism.



Scheme 2.8. Reaction of **12** with triethyl phosphonoacetate anion to form (*R,R*)-**13** in 99% purity

The final examination on the mechanism of the WEC reaction is a study on the *cis*-/*trans*-selectivity of the reaction by Krawczyk *et al.*⁴⁸ In this study the reaction starting from α -phosphono- γ -lactones **14** for the formation of γ -oxyalkylphosphonate anions **15** was examined (Scheme 2.9).

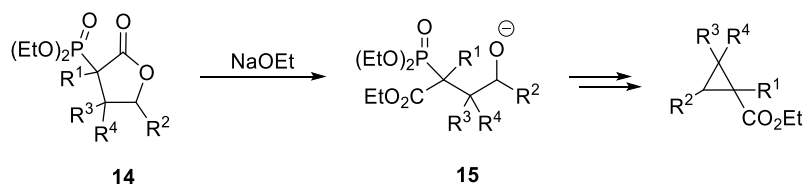

Scheme 2.9. Reaction examined by Krawczyk *et al.*

The intermediate enolate **16** formed in this reaction (Scheme 2.10) is analogous to that proposed by Denney *et al.*⁴⁴ (Scheme 2.1, p. 31). From **16**, chelated to the metal counterion, it can be deduced that Route 1 (Scheme 2.10) is favoured when $\text{R}^1 = \text{H}$, while Route 2 is favoured when R^1 and $\text{R}^2 = \text{alkyl or aryl}$, due to steric hindrance when R^1 and R^2 are both bulky groups.

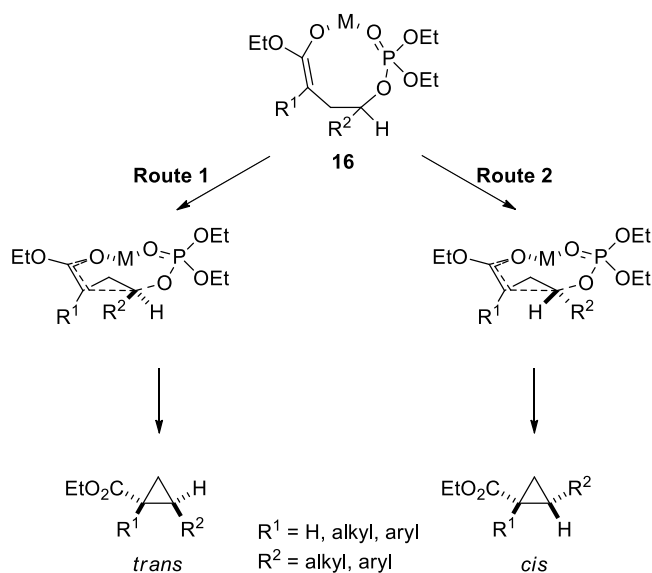

Scheme 2.10. Intermediate chelate structures proposed by Krawczyk *et al.*

The above papers represent the major investigations into the mechanism of the WEC reaction. These reports outline the reasons why the WEC reaction is generally *trans*-selective, with the *trans* diastereomer being thermodynamically favoured while the *cis* diastereomer is kinetically favoured. The general consensus from these investigations is that the WEC proceeds *via* a stepwise decomposition route, allowing equilibration to the *trans* isomer before cyclisation to form the cyclopropane. It is also possible that concerted decomposition can occur to a very minor degree, which could lead to a loss of enantioselectivity.

However, it has been demonstrated for the Horner–Wadsworth–Emmons (HWE) olefination reaction that, with alterations to the reaction conditions, the selectivity can be altered for formation of the *cis* isomer.⁴⁹ Temperature has the largest effect in this regard, with low temperatures giving the *cis* isomer, while the *trans* isomer is formed at higher temperatures that enable isomerisation. The counterion and solvent also slightly affect the reaction, with strongly coordinating counterions favouring the *trans* isomer. Solvents with larger abilities to solvate the intermediate ionic species drive the forward reaction, also favouring the formation of the kinetically favoured *cis* isomer. These factors could also be predicted to affect the stereoselectivity of the WEC.

2.2 Results and Discussion I

2.2.1 Synthesis of cyclopropane substrates

2.2.1.1 Synthesis *via* the cyclopropyl ester

The aim of this project was to develop an iminium ion catalysed nucleophilic ring-opening reaction for cyclopropanes. For this, the cyclopropyl aldehyde starting materials were synthesised *via* the WEC reaction. We decided to focus on two model compounds, ethyl 2-phenylcyclopropanecarboxylate **17** and ethyl 2-((benzyloxy)methyl)cyclopropanecarboxylate **18** (Fig. 2.2). These were chosen to provide both a benzylic and a non-benzylic site respectively for ring-opening of the cyclopropane.

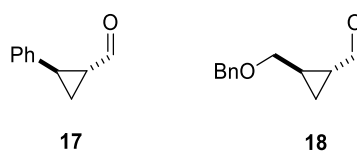
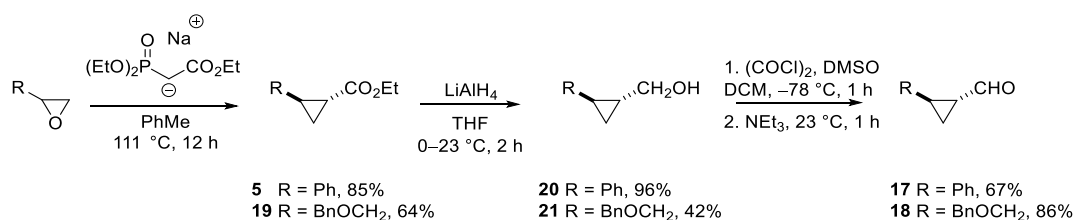

Fig. 2.2. Model compounds for development of the ring-opening reaction

Both compounds were initially synthesised from the corresponding epoxide following a known WEC procedure to form the cyclopropyl esters **5** and **19**.^{42h} This ester was then converted to **17** and **18** by reliable procedures, with reduction to the corresponding alcohols **20** and **21** using LiAlH_4 , followed by Swern oxidation to the aldehyde to give the desired substrates (Scheme 2.11).



Scheme 2.11. Our first synthesis of cyclopropane substrates

2.2.1.2 Synthesis *via* cyclopropyl nitriles

Attempts to reduce the number of steps to **17** and **18** by direct DIBALH reduction of the ester to the aldehyde resulted in a 1:1 mixture of aldehyde and alcohol, as well as some recovered starting material. With optimisation, *e.g.* controlled addition of DIBALH, the sole formation of the aldehyde may have been achieved.

However, we decided instead to proceed by the more facile route *via* the nitrile rather than the ester, requiring less time-consuming optimisation. Diethyl cyanomethylphosphonate is commercially available but was also readily synthesised *via* the Arbuzov reaction of triethyl phosphite and chloroacetonitrile to give diethyl cyanomethylphosphonate (**22**) (Scheme 2.12).

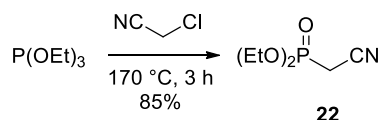

Scheme 2.12. Arbuzov synthesis of diethyl cyanomethylphosphonate **22**

This enabled a straightforward DIBALH reduction of nitriles **23** and **24** to the aldehyde, resulting in a shortened two-step procedure to the desired substrates (Scheme 2.13).

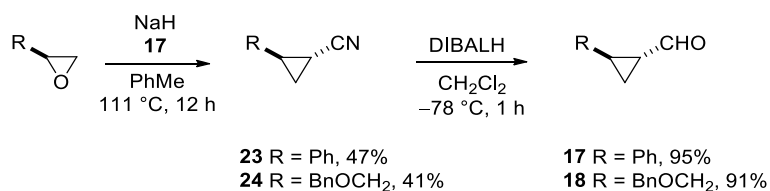

Scheme 2.13. Two-step synthesis of substrates

At this point, the two-step route to **17**, though taking 1.5 rather than 4 days, gave an overall yield of 45% in comparison to 55% for the previous three-step route (Scheme 2.11, p. 38). The second step, using DIBALH, gave a yield of 95%. However, as the cyclopropanation step had decreased from 85% yield for the synthesis of **5** to 47% for **23**, this was the key step to optimise.

Since the reagents were highly insoluble in PhMe it was elected to change the solvent to a more solubilising, polar solvent, DMSO. A yield of 64% had been obtained for ester **19**, but, when the reaction was carried out in refluxing DMSO – *i.e.* at 180 °C – a much improved yield of 92% was obtained for *rac*-**24** (Scheme 2.14), making this reaction more efficient in terms of both time and yield.

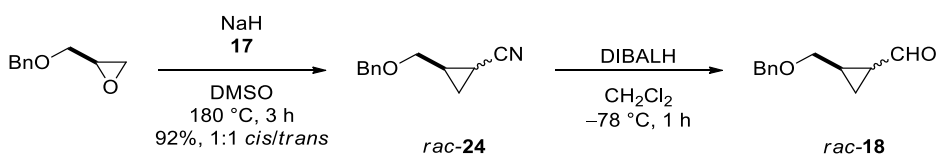

Scheme 2.14. Two-step route to α -cyclopropyl aldehyde **18**

Unexpectedly, this gave a *cis:trans* ratio of 1:1 after column chromatography. To the best of our knowledge, this amount of the *cis*-product had not been observed previously, prompting further investigation of this potentially valuable route to *cis*-substituted cyclopropanes.

When the reaction was previously run in PhMe at 111 °C, a *cis:trans* ratio of 13:87 had been found for cyclopropane **24** after purification by flash column chromatography (Scheme 2.11, p. 38). This reaction is *trans*-selective, with 96:4 dr when using ester stabilising groups,⁵⁰ preventing isolation of the *cis* diastereomer in significant amounts. For the HWE reaction, the *cis-/trans*-selectivity of the reaction can be increased very slightly by factors such as increased steric bulk of the aldehydes, higher reaction temperatures, the phosphonate counterion ($\text{Li}^+ > \text{Na}^+ > \text{K}^+$) and the solvent (DME > THF).⁴⁹ These factors may also contribute to the alterations in selectivity seen for the WEC and were thus taken into account in further investigations (Section 2.2.2). However, this change in selectivity has never been large and never to the degree seen here.

The *cis* and *trans* diastereomers of aldehyde **18** were synthesised from the corresponding diastereomers of nitrile **24** (Scheme 2.14). The reaction of the *trans* diastereomer went to completion under the same conditions as shown in Scheme 2.14. However, the *cis* diastereomer still showed a high proportion, approximately 56%, of starting material as judged by ¹H NMR of the crude material. This indicates that the *cis* diastereomer is much less reactive than the *trans* diastereomer. The bulky diisobutyl group is presumably hindered by the *cis* substituent. The reaction did not go to completion after 20 h, possibly due in part to the degradation of DIBALH over this long period.

2.2.2 Investigation of the stereoselectivity of the reaction

Given the change in stereoselectivity of the cyclopropanation, further investigation of the selectivity was carried out, as discussed below. Unfortunately, the ¹H NMR of the reactions for phenyl-substituted **5**, **23** and the quaternary cyclopropane **25**, analogous to **26** (Fig. 2.3), were not clear enough to accurately determine the *cis/trans* ratio so, as these ratios were determined by ¹H NMR of the crude reaction for the ensuing reactions, the investigation was focussed on the benzyloxy-substituted cyclopropanes alone.

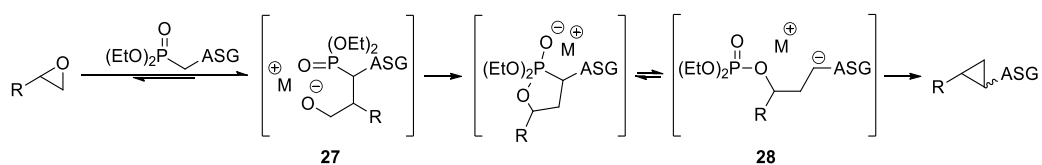

Fig. 2.3. Quaternary cyclopropanes **25** and **26**

Initially, as the temperature had been raised from approximately 110 to 180 °C, the reaction was repeated in DMSO at 110 °C to determine whether the increased temperature alone was causing the observed change. Under these conditions, the *cis:trans* ratio reduced to 1:2, indicating that the temperature had affected the stereoselectivity. However, the abundance of the *cis* diastereomer was still much higher than it had been in PhMe. Therefore, the more polar solvent and/or shorter time of reaction also appeared to be having an effect.

2.2.2.1 Current proposed reaction pathway

In order to rationalise these results, it is necessary to have some idea of the likely reaction pathway. This could potentially proceed as depicted in Scheme 2.15, in a stepwise manner.



Scheme 2.15. Proposed reaction pathway for the formation of cyclopropanes

Intermediates **27** and **28** can be assumed to be more thermodynamically stable when bulky ASG and R groups are *trans* to one another, leading to high levels of diastereoselectivity for the *trans* diastereomer, as proposed by Delhaye *et al.*^{42j} Thus, any alterations that would reduce the steric strain in the *cis* conformation would be expected to lead to a deterioration of the stereoselectivity of the reaction, as this would result in a less significant difference between the thermodynamic stabilities of the two products.

The results of further reactions to delineate this factor are shown in Table 2.1.

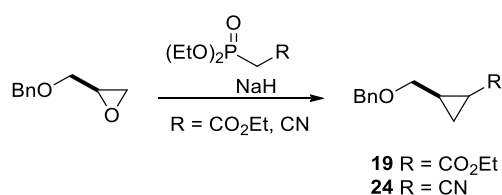
Table 2.1. Screening of conditions for investigation of the stereoselectivity

Entry	Temperature (°C)	Time (h)	<i>cis:trans</i> ratio of product ^a			
			(a) 19 in PhMe	(b) 19 in DMSO	(c) 24 in PhMe	(d) 24 in DMSO
1	110	3	4:96	1:2	14:86	1:2
2	110	12	4:96	1:2	13:87	1:1.2
3	180	3		1:3.2		1:1
4	180	12		1:2.4		1:1.2

^a As judged by the ¹H NMR spectra of the reaction following aqueous work-up

2.2.2.2 Analysis of the solvent effect

It is clear that the solvent has a significant effect on the reaction, with DMSO affording a lower proportion of the *trans* diastereomer (entries 1 and 2, Table 2.1). This could be due to the more polar solvent reducing the coordinating ability of the counterion, resulting in a more reactive, naked anion that would react faster and less selectively. As PhMe is apolar it would allow stronger coordination and a high level of stereoselectivity to be retained.

When the reactions are left for longer times there is little difference seen at 110 °C for the reactions in PhMe (entries 1(a) and 2(a), 1(c) and 2(c)) or for the ester-stabilised product **19** in DMSO (entries 1(b) and 2(b)). However, for nitrile-stabilised **24** in DMSO, the amount of the *cis* diastereomer increases to approximately the same level as the *trans* diastereomer after 12 h (entry 2(d)). The significant difference in the behaviour of the ester- and nitrile-containing compounds under the same conditions demonstrates that the ASG has a significant influence on the *cis:trans* ratio of the reaction.

2.2.2.3 Effect of the anion stabilising group and sterics

It can be reasoned that the size of the ASG would influence the stereoselectivity of the reaction. A larger ASG would increase the stability of the *trans* diastereomer relative to the *cis* diastereomer, giving a high level of *trans*-selectivity. A smaller ASG would decrease the steric hindrance that arises on formation of the cyclopropane and therefore, the difference in the relative stabilities of the *trans* and *cis* diastereomers would decrease. Consequently, the stereoselectivity decreases. This effect is observed in comparing the ratios where only the ASG is changed. A lower proportion of the *trans* diastereomer is formed with the smaller nitrile ASG (entries 1(a) and (c), 2(a) and (c), 2(b) and (d)).

The exception to this is the reactions for 3 h in DMSO (entries 1(b) and (d)), for which both substrates afford the same *cis:trans* ratio. As the isolated yield for **19** in PhMe is 87% after 4 h, it can be presumed that the reactions are largely complete after 3 h. Thus, the significant decrease in the proportion of *trans*-**24** after 12 h indicates that the product itself may be interchanging between the *trans* and *cis* diastereomers *via* epimerisation or a reversible ring-closure or that the *trans* diastereomer degrades more rapidly. The difference in stability between *cis*- and *trans*-**24** under these conditions thus appears to be negligible, with an approximate 1:1 ratio being obtained over time. However, if this is the case, the *trans* conformation of intermediate **28** must be more favoured to afford the initially higher proportion of the *trans* diastereomer. This could be due to chelation of the phosphonate and ASG with the counterion, or other factors such as the optimal alignment of the dipole moment or the influence of π -interactions. Overall, the reaction appears to be non-selective when using the nitrile ASG in DMSO.

For **19** there is no overall change in the ratio. This could be because *trans*-**19** is more stable than *cis*-**19** and/or the bulkier ester group hinders isomerisation.

Further investigation of the effect of sterics was carried out through the synthesis of cyclopropane **26** containing a quaternary carbon (Fig. 2.3, p. 41). At 110 °C in DMSO after 3 and 12 h, a ratio of 1:1.5 *cis:trans* was observed, with no change over time. Again, **26** may not be susceptible to *cis/trans* isomerisation – *i.e.* if the ring-closure is reversible, the additional steric bulk of the methyl group may

hinder the reverse attack of the phosphate group, while any epimerisation at the nitrile centre is eliminated by the absence of a proton on this carbon. However, the larger steric influence of the methyl group (A value of 1.2) over the nitrile group (A value of 0.17) would indicate that *cis*-**26** should be more stable and thus favoured. This is seen to a certain extent, as a higher ratio of *cis*-**26** (*cis:trans* 1:1.5) is afforded at 3 h compared to **19** and **24** (*cis:trans* = 1:2), but the *trans*-selectivity has not fully deteriorated. This emphasises that the level of stereoselectivity is also dependent on other factors. However, the results correlate with a relationship between sterics and the stereoselectivity of the reaction.

2.2.2.4 Effect of the temperature

The temperature has a significant effect on the stereoselectivity of the reaction, with the lowest levels of selectivity being obtained at 180 °C in DMSO for **24** (entry 3(d)). It is expected that a higher temperature would drive the reaction faster and also more readily overcome the thermodynamic barrier for formation of the *cis* diastereomer, leading to a loss of stereoselectivity. There is no significant change observed after 12 h (entry 4(d)), the minor change being attributable to experimental error – *e.g.* in the integration of ¹H NMR signals.

In the case of ester **19** the selectivity for the *trans* diastereomer has increased at 180 °C (entries 3(b) and 4(b)) compared to the equivalent reactions at 110 °C (entries 1(b) and 2(b)). This increase may be due to the steric hindrance of the bulky ester group in conjunction with the higher temperature.

After 12 h the selectivity for the *trans* diastereomer decreased from approximately 75% after 3 h to approximately 70% after 12 h. This could be due to experimental error or isomerisation of the product. Although the *cis/trans* ratio of **19** remained unchanged over time at 110 °C, the higher temperature of 180 °C could drive isomerisation. However, further work is required in order to come to an informed conclusion on these results. Initially, the *cis*- and *trans*-cyclopropanes should be isolated and treated with i) phosphate, ii) NaH and iii) phosphate + NaH under the various reaction conditions to analyse the possibility of a reversible product formation.

2.3 Conclusions I

Although this is by no means an extensive investigation of the stereoselectivity of the WEC, there is clear evidence that a polar solvent decreases the *trans*-selectivity of the reaction, possibly due to competitive chelation of the metal counterion. Decreasing the steric congestion around the cyclopropane also appears to be a factor in eroding the *trans*-selectivity of the reaction. There is a strong possibility that the product itself interchanges between the *cis* and *trans* diastereomers. However, these conclusions have not been satisfactorily proven on the basis of these results alone and there are indications that there are other influencing factors. A thorough examination of a wider range of solvents, ASGs, substrates and temperature is necessary in order to identify a clear trend.

Thus, the initial aim to achieve a *cis*-selective WEC does not appear to be possible by simply utilising a combination of a smaller ASG, higher temperature and more polar solvent, as this has resulted in a deterioration of the stereoselectivity of the reaction rather than an increased selectivity for the *cis*-diastereomer. Other factors such as, for example, a bulkier group on the epoxide could also significantly effect the diastereoselectivity. From this perspective, it would be interesting to examine the effect of further substitution on the epoxide.

2.4 Background II

2.4.1 Nucleophilic ring-opening of cyclopropanes

Cyclopropanes are susceptible to electrophilic attack, are easily oxidised, undergo addition reactions, etc, much like alkenes. This is in part due to the high degree of ring strain which affects their reactivity (for an in-depth discussion see Section 1.2.1, p. 14). However, despite their inherent ring strain, cyclopropanes are relatively resistant to nucleophilic ring-opening reactions, preferring instead to undergo electrophilic attack. This significantly limits their use in organic synthesis.

The homologous (or 1,5-) Michael reaction (HMR), of cyclopropanes, was first discovered by Bone and Perkin in 1895.⁵¹ The potential of this reaction was identified by organic chemists and the reaction has been further developed over the last 119 years. However, as in the case of the first example by Bone and Perkin (Scheme 2.16)⁵¹ the majority of cases demonstrate a requirement for two EWGs (*e.g.* esters, nitriles, imines, phosphinium groups) to activate the ring to simple thermal fission by a nucleophile due to the low susceptibility of the cyclopropane ring to nucleophilic attack.⁵²

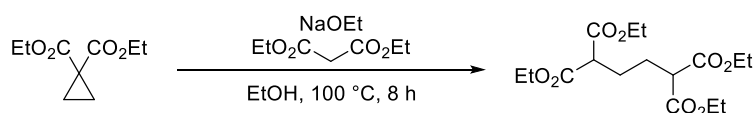

Scheme 2.16. First reported nucleophilic ring-opening of cyclopropanes

Activation of the cyclopropane ring is achieved through the use of an electrophilic partner. This can take the form of an EWG or a Lewis acid⁵³, but can also involve the participation of an external electrophile⁵⁴ (although in these cases it is less clear whether the initial attack is from the nucleophile or the electrophile). As mentioned above, the presence of two EWGs is often sufficient for a relatively mild thermal ring-opening reaction but this requires the incorporation of two groups that may not be desirable in the final product.

Monoactivation of the ring, using only one EWG, is seen more frequently in recent developments. Monoactivated cyclopropanes can react with nucleophiles under forcing conditions – for example, when using strong nucleophiles, such as

Γ^- (A, Scheme 2.17),⁵⁵ morpholine,⁵⁶ thiophenoxide⁵⁷ or phenylselenolates.⁵⁸ They can also be opened by radical methods using, for example, Bu_3SnH ⁵⁹ (B, Scheme 2.17) and cuprates,⁶⁰ or by using metals that can insert into the cyclopropane ring, such as nickel⁶¹ and tellurium⁶² (C, Scheme 2.17).

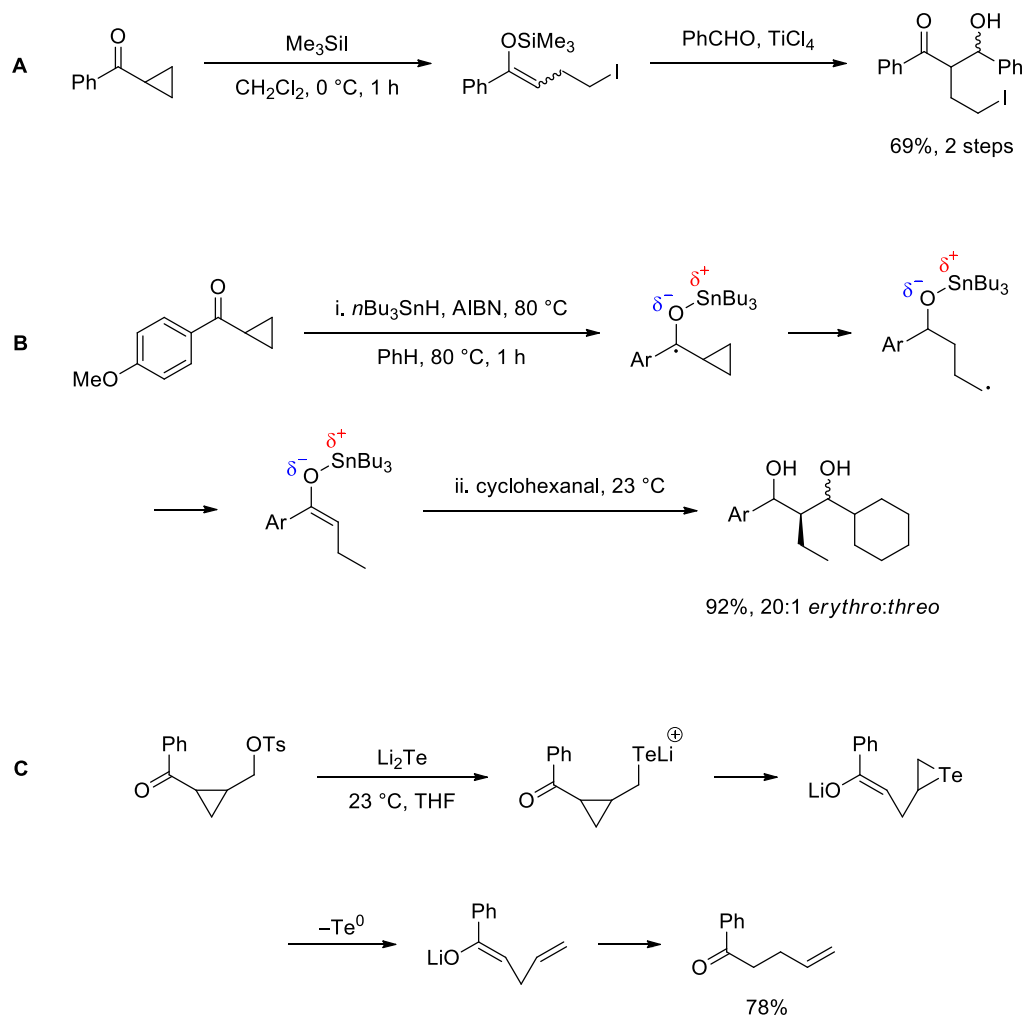

Scheme 2.17. Nucleophilic ring-opening of mono-activated cyclopropanes

Other methods often seen in the literature involve the use of a donor–acceptor system⁵⁴ (which again could potentially be initiated by electrophilic – *i.e.* the acceptor – rather than nucleophilic ring-cleavage), or by further constraint of the cyclopropane in a bi- or tricyclic system.⁶³ In the latter case, the ring that is fused to the cyclopropane is forced into a strained conformation which can be released if the cyclopropane ring is opened. Intramolecular reactions have therefore been shown to proceed under milder conditions than the equivalent intermolecular reactions.^{52e}

However, strictly speaking, excepting those cases where a very strong nucleophile is used, these methods are still examples of dual activation as the presence of another species, in the form of a Lewis acid or another electrophile, is still required.

At the beginning of this project, true monoactivation of the ring had been demonstrated through the use of iminium substituents. The first report of this type of activation was from Boeckman *et al.* in 1985 (Scheme 2.18) in which cyclopropyl aldehyde **29** reacted with pyrrolidine to form an iminium ion **30** via cyanoaminal **31**.⁶⁴ The cyclopropane ring could then be cleaved by both Cl^- and Br^- to give **32** and **33**, respectively. Subsequent hydrolysis gave the aldehyde **34** when using LiCl (Route a). However, use of LiBr led to cyclisation of the intermediate **33** to form **35** as Br^- is a better leaving group than Cl^- (Route b), demonstrating the need to tune the nucleophile in terms of its activity and its leaving group ability.

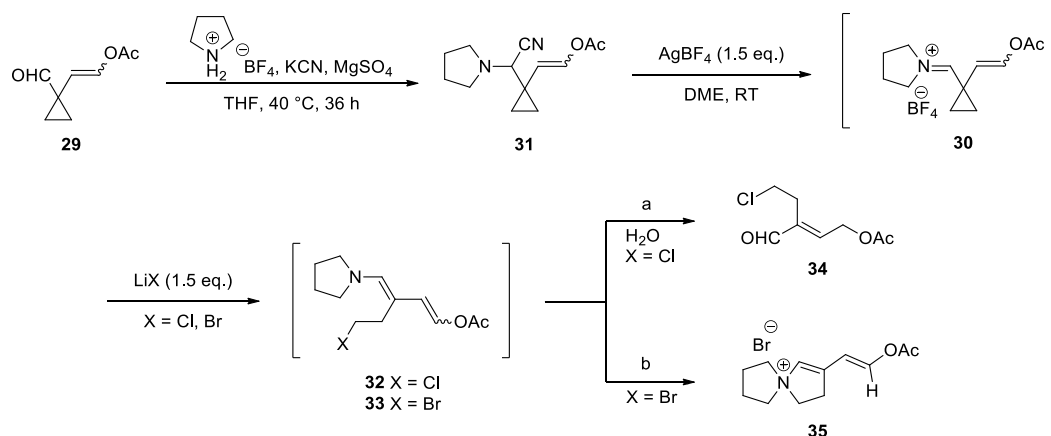

Scheme 2.18. First reported iminium ion driven nucleophilic ring-opening of cyclopropanes

This allows the use of a single EWG, which can be readily converted to an alternative functional group, without the use of expensive or toxic metals or the restriction of the requirement for other substituents – *i.e.* another ring or donor-group on the cyclopropane ring. This represents a huge step forward in the use of cyclopropanes as alkene equivalents.

Despite the apparent promise of this method, there were no reports of iminium ion driven ring-opening of cyclopropanes until 2009 when Li *et al.* described a

similar reaction in which cyclopropyl aldehyde **17** reacted with benzenethiols for the synthesis of benzo[*b*]thiepines (Scheme 2.19).⁶⁵ The aromatic group on the cyclopropane could be replaced by 4-methoxyphenyl, 4-fluorophenyl or a proton.

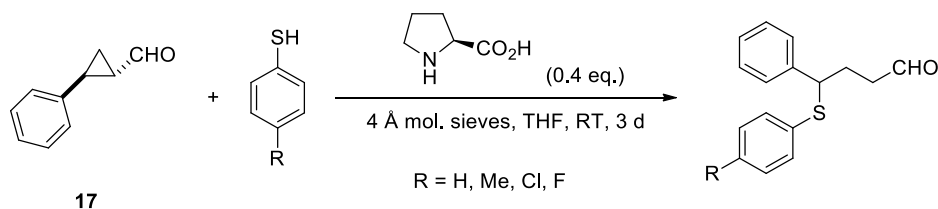

Scheme 2.19. Iminium ion driven nucleophilic ring-opening of **17**

This semi-catalytic reaction developed by Li *et al.* demonstrates the possibility of using organocatalytic methods for this reaction, providing a non-toxic and environmentally friendly alternative to the current abundance of Lewis acid mediated methods. However, the reaction has clear drawbacks – *i.e.* the extremely long reaction time of 3 days for a maximum yield of 55%. Additionally, the requirement for 4 Å mol. sieves seems counterintuitive as it has been shown that water is beneficial for the equivalent reactions with alkenes.⁶⁶ Finally, the scope in terms of the nucleophilic species was restricted to sulfur nucleophiles and with little scope demonstrated in terms of the cyclopropane. These are obvious areas for improvement but the reaction would provide a good starting point for further optimisation. Unfortunately however, we did not find this work until the project was brought to a close and, therefore, we began our studies from a different angle.

2.4.2 Iminium ion driven organocatalysis

The concept of iminium ion catalysis was first developed in 2000 when, along with the development of enamine organocatalysis by List *et al.*,⁶⁷ the MacMillan group published the first example of iminium ion catalysis, using imidazolidinone catalysts for enantioselective Diels–Alder reactions (Scheme 2.20).⁶⁸ This publication was the first of many in which iminium ions are used for the catalysis of a broad range of reactions, such as alkylations, hydrogenations, cycloadditions and Michael additions.⁶⁹ These developments by List and MacMillan initiated a surge of interest in organocatalysis.

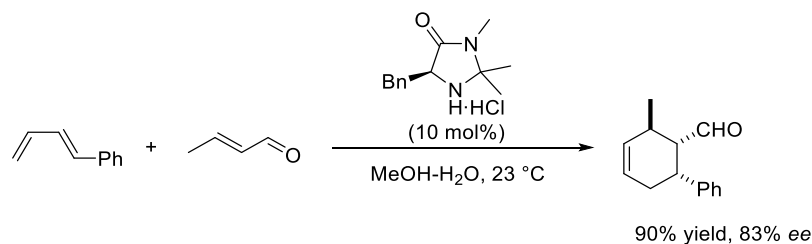

Scheme 2.20. First iminium-ion catalysed reaction procedure reported by the MacMillan group

The catalytic cycles of enamine and iminium ion catalysis are shown in Scheme 2.21. While enamine catalysis proceeds by raising the energy of the HOMO (and effectively shifting the equilibrium of keto–enol tautomerism towards the enol form), iminium ion catalysis proceeds by LUMO activation, by which the energy of the LUMO is lowered to become closer to that of the HOMO.

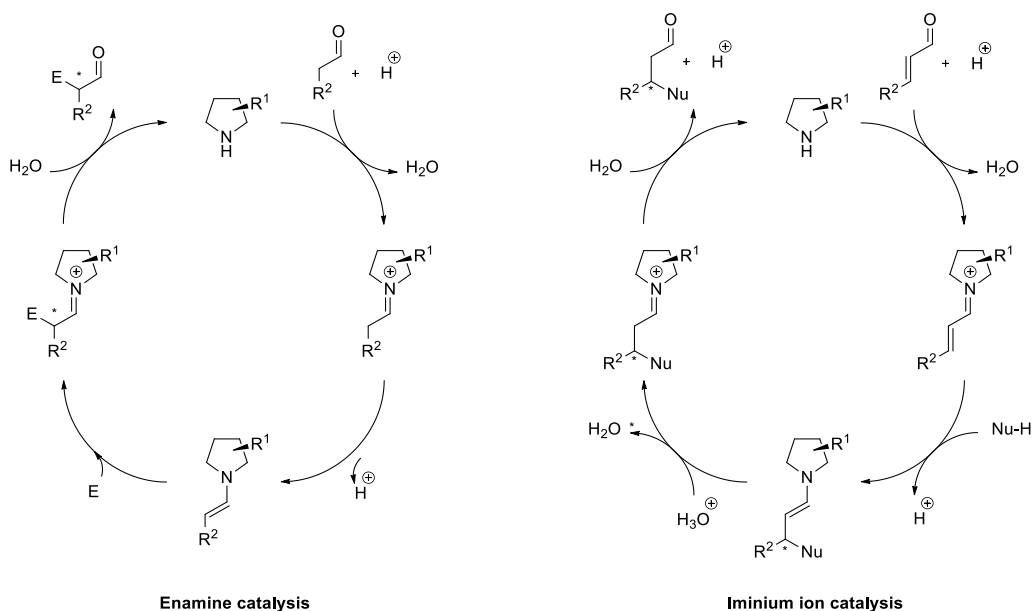

Scheme 2.21. Mechanisms of enamine and iminium ion catalysis

With the burgeoning interest in iminium ion organocatalysis, there have now been numerous experimental and theoretical studies on the reaction, including DFT, solid state and solution state studies, several of which focus on Michael addition reactions, which would proceed by an analogous mechanism to the nucleophilic ring-opening of cyclopropanes. The accuracy of these studies has been shown to be within acceptable limits, with solid, liquid and gas state results obtained from X-ray crystallography, NMR and DFT studies correlating extremely well with one another.⁷⁰

bonding with the water/acid complex. The subsequent formation of the iminium ion **40** proceeds in the same manner for both routes, with loss of two water molecules and generation of the chloride counterion.

Energy calculations for both routes were calculated and the first route was predicted to be favoured as, although the total energy of the final product is lower by Route 2, the energy required for each step is much lower in Route 1. The third step is a reversal of the first step with hydrolysis favoured on the *Si* face due to steric hindrance.

2.4.2.2 The effect of the counterion

The nature of the counterion can also have an impact on the reaction rate. For example, Fleischer and Pfaltz found conjugate addition to *trans*-cinnamaldehyde with dibenzylmalonate was inhibited by strong acids such as triflic acid, while weak acids such as benzoic acid give a strong rate enhancement.⁷² Lakhdar and Mayr also investigated the role of the counterion on the rate of reactions of electrophilic aromatic substitution on pyrroles (Scheme 2.23).⁷³

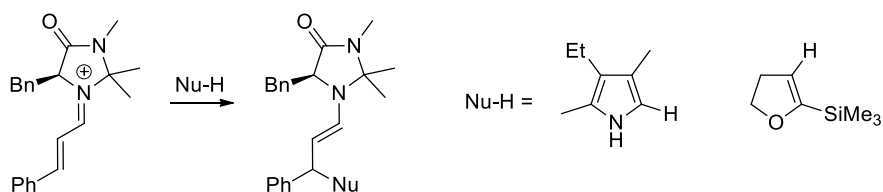

Scheme 2.23. Reaction studied by Lakhdar and Mayr

They found that substitution on pyrrole was affected by the counterion – with reactions with the CF_3CO_2^- ion proceeding twenty six times faster than those with TfO^- , indicating, in this case, that stronger bases give faster reactions. However, reactions with ketene acetals were little affected by the nature of the counterion. These publications show that a strong conjugate base will give a faster rate of reaction.

2.4.2.3 The enantioselectivity of iminium ion catalysed Michael addition

The enantioselectivity of iminium ion catalysed reactions is extremely high. There are many theories as to the reasons behind this and it appears to be a combination of steric and energetic requirements.

The position of the benzyl group of the catalyst in the iminium intermediate has been studied extensively by X-ray crystallography, NMR and DFT studies, as it is the major contributor to the enantioselectivity. Initial computational studies by the MacMillan group found the phenyl ring was positioned above the π -system and this was cited as the source of the enantioselectivity, with attack at the *Re* face blocked (Fig. 2.4).⁷⁴

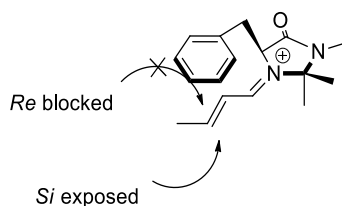

Fig. 2.4. Model proposed by the MacMillan group for iminium ion intermediate

However, since then the general consensus has been that the benzyl group is, in fact, in its most stable conformation when the phenyl group is positioned above the heterocyclic ring of the catalyst (Fig. 2.5). The first group to put forward this theory was that of Houk, who found this conformation by computational studies on the intermediate **41** in the reaction of the *gem*-dimethyl substituted catalyst **cat 1** and (*E*)-crotonaldehyde (Scheme 2.24).⁷⁵

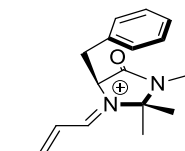
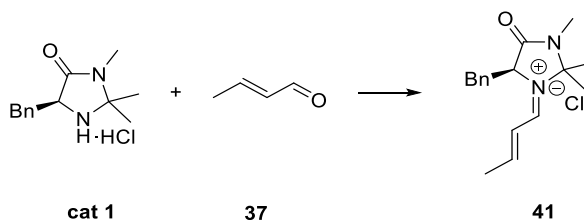

Fig. 2.5. Model proposed by Houk for iminium ion intermediate



Scheme 2.24. Reaction of catalyst **cat 1** with (*E*)-crotonaldehyde (**37**)

This was corroborated by the Tomkinson group through solid and solution state studies.⁷⁶ X-ray crystallographic studies of **cat 1** show that the benzyl group is extended when the catalyst has not reacted but is in the conformation described

by Houk when the iminium intermediate **41** is formed. Solution state NMR studies show that the relative positions of the two methyl groups reverse upon reaction, with the β -methyl signals shifted upfield in both the ^1H and ^{13}C NMRs. This indicates that the β -methyl group is shielded by the phenyl ring, again corroborating Houk's model. To confirm this, intermediate **42** (Fig. 2.6) was subjected to the same experiments. In the absence of the shielding effect of the phenyl ring, there was little alteration to the relative positions of the two methyl groups. The Seebach group also saw similar effects through NMR studies and concluded that there must be a certain population of the molecules in which the phenyl group faces the *cis*-methyl group.⁷⁷ Lakhdar *et al.* also corroborated Houk's model through NOE experiments.⁷⁸

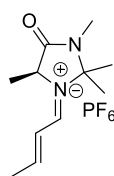

42

Fig. 2.6. Non-benzylated imidazolidinone **42**

The Tomkinson group also demonstrated that the thermodynamically favoured conformation was that described by Houk's group as the upfield shift is more pronounced at lower temperatures.⁷⁶ This was supported by computational studies. They cite this model as the reason for the poor *ees* observed using the *gem*-dimethyl catalyst **cat 1** when compared to the *tert*-butyl-substituted catalyst **cat 2** (Fig. 2.7), as the bulky *tert*-butyl group would force the benzyl group into a position above the π -system, as was initially proposed by the MacMillan group, and thus the benzyl group shields the *Re*-face.⁷⁴

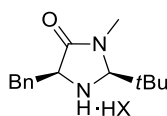

cat 2

Fig. 2.7. *tert*-Butyl substituted catalyst **cat 2**

This model is again complicated by reports from Seebach *et al.* where another conformation of the intermediate, with the benzyl group pointing away from both

the π -system and the heterocycle (Fig. 2.8) was found through X-ray crystallographic studies.⁷⁹ In this investigation the PF₆ salts of 5-benzyl-1-isopropylidene- and 5-benzyl-1-cinnamylidene-3-methylimidazolidin-4-ones with various substituents in the 2-position were studied.

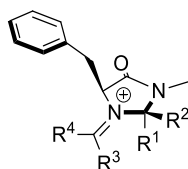

Fig. 2.8. Third model for structure of iminium ion intermediate

It was found that, out of fourteen crystal structures, nine place the phenyl ring above the heterocycle (A), three place it above the π -system (B) and two place it pointing away from both (C) in a close to eclipsed conformation (Fig. 2.9).

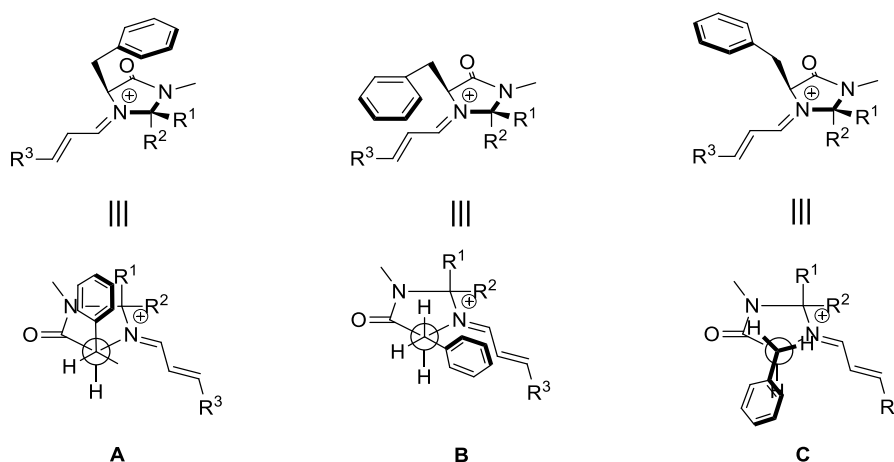

Fig. 2.9. Conformers found by Seebach *et al.* in X-ray crystallographic analysis

These conformations were also reported as energy minima in Houk's work, which was described above.⁷⁵ Seebach *et al.* proposed that the benzyl group is "in a constant state-of-emergency" due to unfavourable interactions in each conformation.⁷⁹ The theoretical and experimental results indicate that the benzyl group freely rotates in a "windshield-wiper" effect as a result of the small energy differences and low rotational barriers between conformers at ambient temperatures. This provides the desired enantioselectivity.

Another important aspect of the enantioselectivity of these reactions is the (*E*)/(*Z*) conformation of the iminium ion intermediates. The Seebach group performed X-

ray crystallography, NMR and DFT studies on the iminium intermediates formed from diarylprolinol or imidazolidinone derivatives and α,β -unsaturated aldehydes.⁷⁷ They found that almost all of these iminium salts exist in solution as diastereomeric mixtures, with (*E*)/(*Z*) ratios ranging from 88:12 to 98:2, and also observed (*E*)/(*Z*) interconversions. They concluded that the (*E*)-isomer must react with nucleophiles faster than the (*Z*)-isomer in order to explain the high *ees* observed for these reactions, which they attribute to the greater steric stress that would be generated upon nucleophilic attack on the (*Z*)-isomer.

Sparr and Gilmour performed conformational studies on preformed fluorinated intermediates **43** and **44** which correspond to conformers **45** and **46** respectively (Fig. 2.10).⁸⁰ They found that the (*E*)/(*Z*) ratios for both were similar, but that the ratio for **43** was consistently lower than that of **44**. This is consistent with the opposing steric strain of the *gem*-dimethyl group and the freely rotating benzyl group over the reactive centre. They conclude that the conformation of **44** contributes to efficient catalysis by minimising $A^{1,3}$ strain and thus improving geometric control.

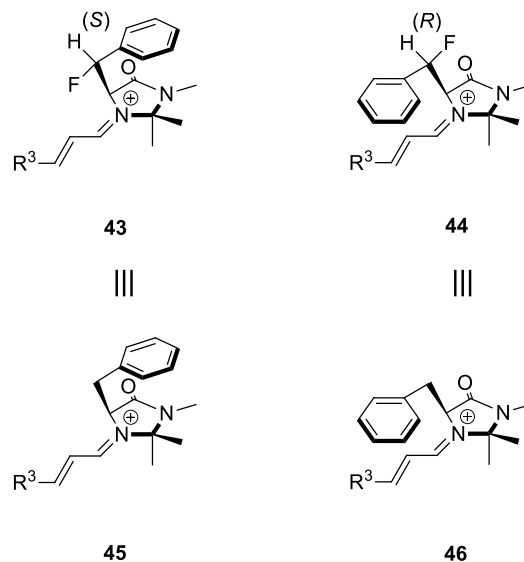
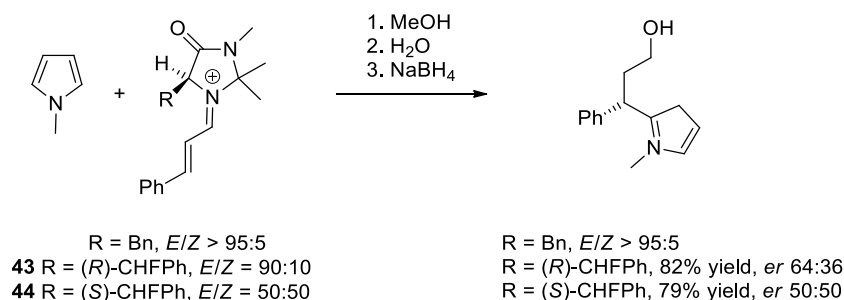

Fig. 2.10. Fluorinated compounds studied by Sparr and Gilmour

Sparr and Gilmour also compared the reactions of **43** and **44**, as well as the non-fluorinated equivalent, with *N*-methylpyrrole (Scheme 2.25).⁸⁰ They found that **43** gives an *er* of 64:36, **44** gives 50:50 and the non-fluorinated compound gives an *er* of 89:11. This indicates that, while **44** provides geometric control, **43** gives

high levels of enantioinduction, while for the non-fluorinated compound the (*E*)/(*Z*)-ratio is inconsequential as the bond rotation from **43** to **44** is much faster.



Scheme 2.25. Reaction studied by Sparr and Gilmour

These studies show that, while there is an (*E*)/(*Z*) mixture in these reactions, the steric influence of the benzyl group and the other substituents on the ring have a much greater influence and, therefore, the presence of the (*Z*)-isomer has little effect on the enantioselectivity of the reaction.

2.4.3 Summary of the major points

At the beginning of the project, the nucleophilic ring-opening of cyclopropanes had been achieved in three ways:

1. The cyclopropane ring is activated by the presence of two EWGs, which must therefore be present in the straight-chain product. This reduces the scope of the reaction.
2. The cyclopropane ring can be activated by one EWG if metals are used during the ring-opening process as, for example, catalysts or radical donors.
3. An organocatalytic process for cyclopropanes had been achieved but performs poorly and could therefore be greatly improved.

The use of iminium ions as organocatalysts would provide an alternative route to those using heavy metals. The MacMillan-type organocatalysts can be used for Michael addition on alkenes, providing high yields and high levels of enantioselectivity. This enantioselectivity is due to the ability of the benzyl substituent on the imidazolidinone structure to shield one face of the alkene. The benzyl group is in its most stable conformation when it is positioned above the imidazolidinone core, but with bulky substituents on the imidazolidinone, it can be forced out of this position, resulting in a “windshield-wiper” effect which

shields the upper face of the alkene and gives facial selectivity. The iminium ion intermediate is largely in the (*E*)-conformation, affording further enantioselectivity.

The presence of water helps to drive this reaction forward through a proton-shuttle role and the reaction, therefore, does not require anhydrous conditions or solvents. The cocatalyst coordinates with the aldehyde group to lower the activation barrier for nucleophilic attack from the imidazolidinone catalyst. The nature of this cocatalyst affects the reaction rate, although its effect appears to be specific to each reaction – *i.e.* in some cases, weaker acids are suitable, while in others stronger acids are better.

2.5 Results and Discussion II

2.5.1 Initial attempts at ring-opening

With the starting materials in hand, attention turned to the development of the ring-opening reaction. Initially we attempted the stoichiometric formation of a cyanoaminal, as reported by Boeckman for the subsequent formation of a tetrafluoroborate iminium salt which would then be ring-opened with either LiCl or LiBr.⁶⁴ We applied these reported reaction conditions to substrates **17** and **18** (Scheme 2.26).

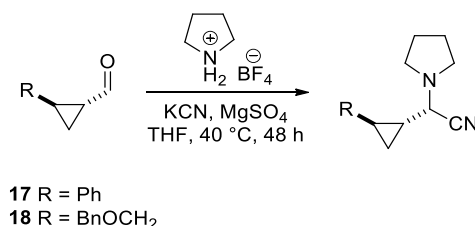

Scheme 2.26. Conditions for formation of cyanoaminal

Due to the nature of these compounds it seemed likely that they could degrade on purification so all analysis was carried out on crude material. This resulted in a highly contaminated, difficult to read ¹H NMR but IR analysis showed no signal for the nitrile group in the expected region.

As an excess of aldehyde had been used, according to the original conditions, it was decided to repeat the reaction with 1 equiv. of the pyrrolidinium salt. There was a noticeable difference by TLC analysis and the ¹H NMR data showed a singlet at δ 4.70 ppm, which is within the range found in the literature for a cyanoaminal proton (3.03–5.05 ppm).⁸¹ However, this signal would be expected to be a doublet rather than a singlet so this evidence was inconclusive.

Comparison of the aryl and aldehyde signals showed that the aldehyde signal was diminishing proportionally, indicating that a reaction had taken place to some extent. Given that the formation of the cyanoaminal was not certain, and because some aldehyde still remained, it was decided to alter the reaction conditions in order to completely consume the aldehyde and form either the aminal **47** and **48** or the iminium ion **49** and **50** (Fig. 2.11).

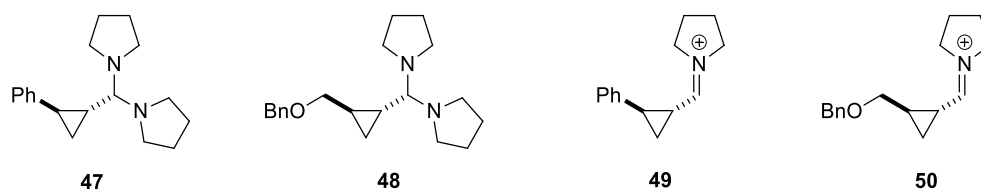
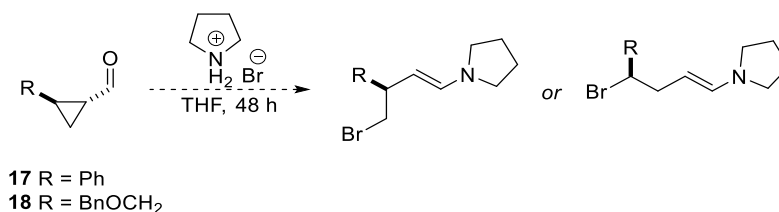

Fig. 2.11. Iminium and aminor products

As there was no evidence of a nitrile signal in the IR spectra of the initial reactions and since it would, in any case, be removed in the second step of the reaction, it was also decided to run future reactions without KCN. Several reactions were run using the pyrrolidinium salt in excesses of 1.5, 2.0, 5.0 and 10.0 equiv. in an attempt to push the reaction forward. All other conditions remained as previously.

The aldehyde signal was still evident and showed little change in intensity, even when using 10.0 equiv. of the salt. However, as the formation of the aminor or iminium ion is reversible and it was possible that the aldehyde was regenerated on aqueous work-up, it was decided not to attempt to isolate the intermediate and to continue with the ring-opening step. This would assist in determining whether the intended reaction was taking place as the proposed iminium ion intermediate is necessary to drive the ring-opening reaction forward.

A one-pot reaction was employed based on the next step of Boeckman's work, in which ring-opening of the cyclopropane occurs *via* attack by a bromide ion.⁶⁴ To carry this out in one pot, the pyrrolidinium tetrafluoroborate salt was replaced by pyrrolidinium bromide. This would combine both the nucleophilic ring-opening of the cyclopropane and the amination in one step using one reagent, which would be highly advantageous if successful (Scheme 2.27).



Scheme 2.27. Proposed one-pot procedure for nucleophilic ring-opening of the cyclopropane

The reaction was performed at 40 and 77 °C in the absence of MgSO₄ as it has been shown in the literature that ambient water can help to drive both nucleophilic ring-opening^{53e} and iminium-ion catalysed reactions.^{64a,82}

¹H NMR analysis of experiments using 2.0 equiv. and 10.0 equiv. of pyrrolidinium bromide showed a minor signal in the expected range for a bromomethylene proton (δ 3–4 ppm)⁸³ which was promising, although inconclusive.

With no conclusive results having been achieved using this route, attention turned to screening of nucleophiles using MacMillan's imidazolidinone catalysts, which can be expected to form an iminium ion intermediate with the cyclopropyl aldehydes due to the similar reaction profile of cyclopropanes and alkenes.

2.5.2 Screening of reaction conditions

2.5.2.1 Heteroaromatic nucleophiles

Initially it was decided to screen N₃⁻ and 1-methylindole as nucleophiles. These were chosen to provide both a hard and a soft centre of attack respectively. N₃⁻ is also a strong nucleophile ($N = 20.53$) according to the Mayr database of nucleophilicity⁸⁴ while 1-methylindole has been used successfully in MacMillan's work in the area.^{83b} Strong nucleophiles such as Br⁻ and I⁻ were not used as they have can potentially give cyclised product **51** since they are also good leaving groups (Fig. 2.12).

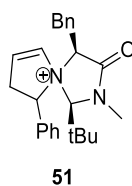
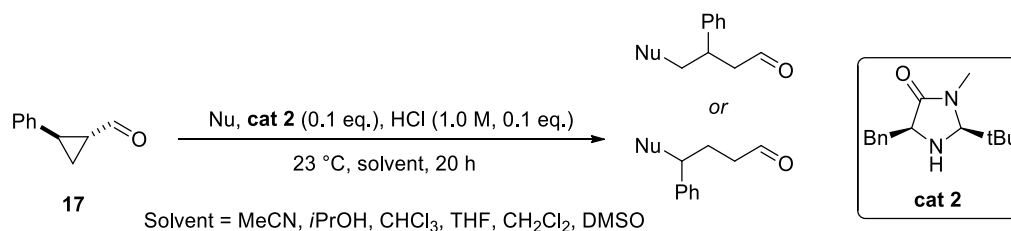

Fig. 2.12. Potential ring-closed product when using Br⁻ or I⁻ as nucleophile

1-Methylindole and NaN₃ were screened against **17** initially (Scheme 2.28, Nu = nucleophile). The aldehyde (1.0 equiv), **cat 2** (0.1 equiv), a solution of HCl (0.1 equiv, 1.0 M in the appropriate solvent) and the nucleophile (2.0 equiv) were stirred at 23 °C for 12 h in solvent (MeCN, *i*PrOH, CHCl₃, THF, CH₂Cl₂ and DMSO). **Cat 2** is only available as the free amine and therefore addition of acid

as a cocatalyst was required. The reactions were monitored by TLC for consumption of **17** and formation of product.



Scheme 2.28. Nucleophilic ring-opening reaction conditions using **cat 2**

NaN₃ gave no reaction. However, 1-methylindole showed complete consumption of starting material in MeCN and partial reaction in *i*PrOH and CHCl₃ but no desired product formation was evident for these reactions.

The solvent was removed *in vacuo* from the reaction mixture and a crude ¹H NMR was obtained. Neither the characteristic cyclopropane signals of the starting material nor an aldehyde signal were evident in this NMR. However, as the starting material had been consumed, some control reactions were run against **17** in order to ascertain with what it was reacting (Table 2.2).

Table 2.2. Control reactions of 1-methylindole reaction with **17** (1.0 equiv) using **cat 2**^a

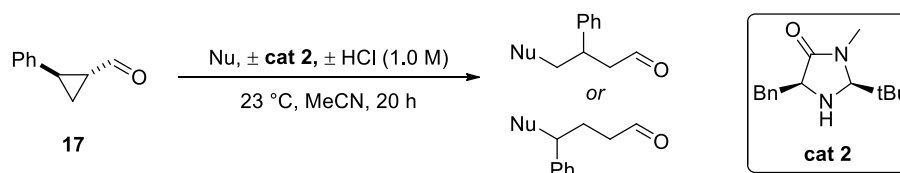

Entry	Equiv. 1-methylindole	Equiv. cat 2 ^b	Result
1	2.0	0.0	No reaction
2	0.0	0.1	No reaction
3	0.5	0.1	Reaction

^a Reactions were monitored by TLC analysis. ^b An equal amount of HCl (1.0 M) was added.

In the presence of both **cat 2** and 0.5 equiv. of 1-methylindole there was complete consumption of nucleophile with 40% consumption of **17** as judged by ¹H NMR analysis (entry 3, Table 2.2), providing evidence that the reaction was occurring between **17** and 1-methylindole. The reaction in the absence of **cat 2** did not proceed (entry 1) showing that the reaction requires the presence of **cat 2** to

proceed. Additionally, there is no product formation without 1-methylindole (entry 2), which removes the possibility of aldehyde **17** reacting with another molecule of **17**.

With this evidence of a catalyst-dependent reaction between the nucleophile and the cyclopropane in hand, it was decided to screen a library of nucleophiles in order to get a broader picture of the process with different types of nucleophiles. Heterocyclic nucleophiles were favoured as these were shown to react readily in this type of reaction by the MacMillan group.^{82a} Reference was also made to Mayr's database⁸⁴ with a range of N values between that of Cl^- ($N = 17.20$ in MeCN) and Br^- ($N = 11.70$ in H_2O) being preferred, as Boeckman had shown previously that both can attack the cyclopropane ring in these iminium ion driven processes.^{64a} Nucleophiles were sourced from chemicals that were already in the group's inventory, leading to a somewhat random selection (Fig. 2.13). Each nucleophile was screened against **17** with **cat 2** in MeCN, CHCl_3 and THF. N values are given as either approximate values based on similar structures found in the Mayr database, or as known values in MeCN.

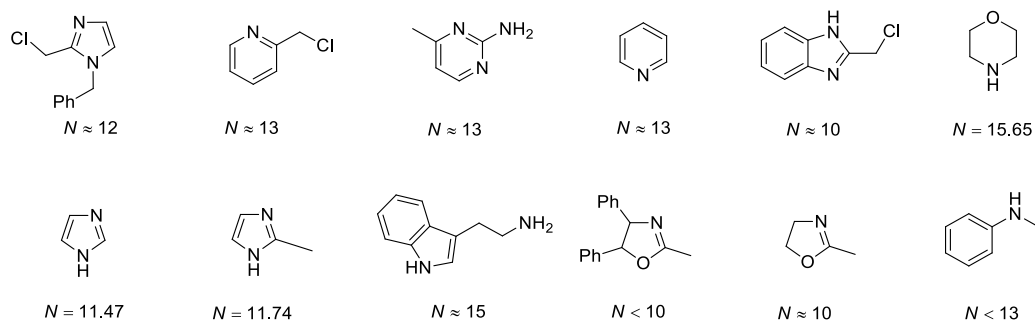
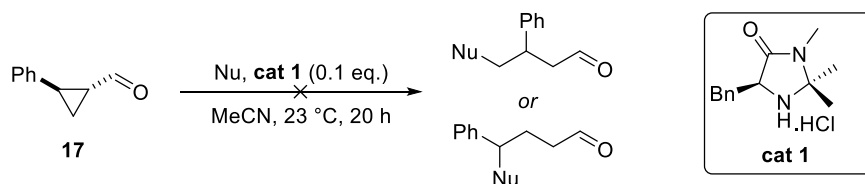

Fig. 2.13. Nucleophiles screened against **17** using **cat 2**

The reactions were monitored by TLC and complete consumption of **17** was seen for *N*-methylaniline in MeCN, whose N value was judged to be less than 12.64, which is the value for aniline in MeCN. In this case, ^1H NMR of the crude reaction mixture showed a signal at δ 9.80 ppm, which could correspond to the aldehydic proton of the desired product. None of the other potential nucleophiles showed any activity.

Following this, the reactions of 1-methylindole and *N*-methylaniline were repeated using **cat 1** (Scheme 2.29). This catalyst was only available as the acid

salt so no acid was added to these reactions. However, using this catalyst no reaction took place with either nucleophile, as judged by TLC.



Scheme 2.29. Cat 1 mediated reactions of 1-methylindole and *N*-methylaniline with **17**

With this unexpected result it was thought that the addition of free acid to the reaction mixture was the driving force for the previous reactions, as the substitution of the *tert*-butyl group for the *gem*-dimethyl group may slow the reaction down but it was not expected that it would shut down completely. This theory was reinforced when the reactions were run using L-proline and HCl (1.0 M) as the catalyst system, which showed complete consumption of **17** overnight for both nucleophiles. It may be that a small excess of acid was added due to the small scale of these reactions and that this was driving faster attack at the aldehyde group.

Other possibilities considered were: (i) that the acid itself was breaking the cyclopropane ring and (ii) that Cl^- was acting as a nucleophile in the reaction. It is known that acid can cleave cyclopropane rings but this seemed unlikely as *trans*-2-phenylcyclopropanecarboxylic acid had previously been exposed to 98% H_2SO_4 at 78 °C (in order to perform a Fischer esterification) and this had not cleaved the ring, implying that these compounds are stable to acidic conditions. The control reactions of **17** with **cat 2** (entry 2, Table 2.2, p. 62) and with 1-methylindole (entry 1, Table 2.2) also show that the ring is only cleaved in the presence of both 1-methylindole and **cat 2**, which also indicates that Cl^- is not acting as a nucleophile.

In order to investigate the second possibility, the aldehyde was subjected to various concentrations of HCl (1.0 M, 5.0 M and 11.6 M) under the same conditions as previously, excluding alternative nucleophiles. This resulted in no degradation of **17** so Cl^- does not appear to be acting as a nucleophile in these reactions.

As CF_3CO_2^- is less nucleophilic than Cl^- , it was then decided to preform a salt of **cat 2** using trifluoroacetic acid (TFA) (**cat 2.TFA**). From the evidence listed above, it was expected that this catalyst would also result in no reaction, as there would be no excess acid in the reaction mixture. However, using this catalyst the reaction also went to completion, leading to the conclusion that the catalyst, rather than the acid, did in fact cause the reaction to shut down.

2.5.2.2 ^1H NMR analysis of heteroaromatic nucleophiles

The reactions were repeated using both **cat 1** and **cat 2** (along with control reactions) and crude reaction mixtures were this time examined by ^1H NMR. Control reactions of both nucleophiles with either catalyst and with the aldehyde showed no activity. However, control reactions of **17** with both **cat 1** and **cat 2** gave a signal at δ 9.74 ppm in a ratio of 0.07:1 and 0.08:1 to the aldehyde, respectively. This indicates approximately 7% conversion, to what was presumably the iminium intermediate, with respect to the aldehyde. This was a positive indication that the first step was proceeding as expected with both catalysts.

The reactions of 1-methylindole and *N*-methylaniline with **17** in the presence of **cat 2** both showed the same results as previously. However, when **cat 1** was used, there was no evidence of reaction using either nucleophile, confirming that **cat 1** was not effective in these reactions. It could also be deduced that it is the second step in which the reactivity is affected as the aldehyde appeared to react with both catalysts in the same way.

The final screening of heterocyclic nucleophiles was carried out on both **17** and **18**, with 1-methylpyrrole, 1,2-dimethylaniline (as well as 1-methylindole and *N*-methylaniline in the case of **18**). Both **cat 2.TFA** and **cat 1** were screened. The usual control reactions of: (a) aldehyde + catalyst, (b) aldehyde + nucleophile and (c) catalyst + nucleophile were carried out and showed no activity for (b) and (c). In this case, (a) gave a signal at δ 9.74 ppm for both aldehydes, which was again approximately 7% with respect to the aldehyde. This chemical shift is in the correct range for an iminium proton⁷⁸ so this was very positive.

In the case of **17**, there was no reaction with either of the new nucleophiles. **18** also showed no reaction with 1-methylpyrrole, 1-methylindole and *N*-

methylaniline. However, **18** did react with 1,2-dimethylindole but, although this showed consumption of the aldehyde, the cyclopropane itself had not been cleaved. This showed that, although a catalytic reaction was taking place with these heterocyclic compounds, it was not the reaction that had been hoped for and instead appeared to be a direct attack on the aldehyde or the iminium ion. One possible product, which was deduced from the coupling of a doublet at δ 4.10 ppm with a cyclopropyl CH signal, is shown in Fig. 2.14. Therefore, although the indole nucleophile is soft, it may be reacting at the harder electrophilic centre.

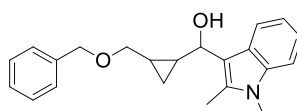

Fig. 2.14. Possible product of the reaction of **18** with 1,2-dimethylindole

This is unexpected due to the soft nature of the nucleophile, which could be expected to attack through a Michael-type addition rather than directly on the carbonyl or imine carbon. However, these nucleophiles may not be sufficiently strong to open the cyclopropane ring.

2.5.2.3 Screening of anionic nucleophiles

All attempts at purification of the reactions described in the previous section were unsuccessful and there was, therefore, little else that could be learned if this line of investigation was continued. It was decided to return to screening of anionic nucleophiles, which had been shown by Boeckman to cleave the cyclopropane ring⁶⁴ and should, therefore, attack at the desired position.

Aldehydes **17** and **18** were screened against LiCl, LiBr, TBAB and a mixture of NaN₃ and TBAB. These reactions were monitored by TLC and by ¹H NMR. The only positive sign in this screening was the reaction of **17** with Br⁻ at room temperature and with TBAB at 50–60 °C for 48 h (Scheme 2.30) using both **cat 1** and **cat 2**. The ¹H NMR for this reaction showed some minor signals (integrating at approx. 0.25:1 with respect to the aldehydic proton) in the region of 4.5–6 ppm. The multiplicities and integrals of these signals did not correspond to those that would be expected for the potential products. **18** did not show any activity in these reactions.

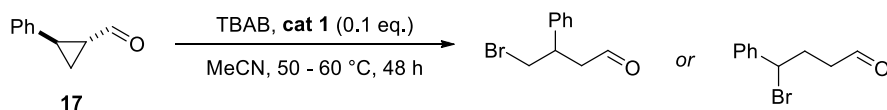

Scheme 2.30. Reaction of **17** with TBAB using **cat 2**

Given these disappointing results, the next step was to examine the formation of each intermediate individually.

2.5.3 Preforming the iminium ion

The desired reaction proceeds *via* the iminium intermediate (Scheme 2.31).

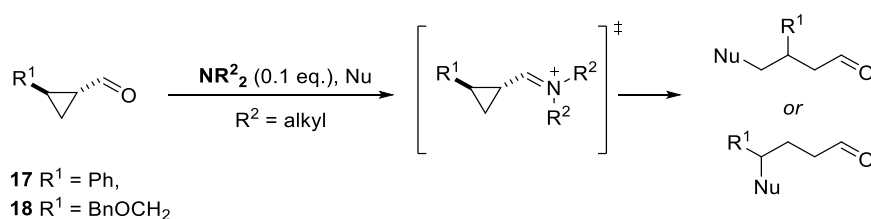

Scheme 2.31. Desired reaction route

To establish that the formation of the iminium ion was possible with the chosen substrates, the benzyl substituted imine **52** was formed by the reaction of **15** with benzylamine in the presence of K₂CO₃ (Scheme 2.32). This was achieved in both CDCl₃ and CD₃CN.

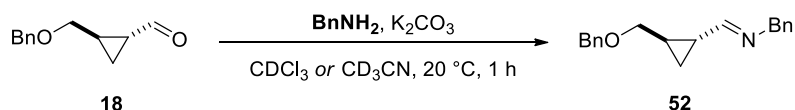

Scheme 2.32. Formation of imine derivative **52**

This imine was characterised by the disappearance of the aldehyde signal in the ¹H NMR as well as a shift in the cyclopropyl region. The COSY also showed coupling between a signal in the aromatic region and one of the cyclopropane signals, which indicated that the imine CH signal was masked by the aromatic signals. This sample was used directly in the next step and a fresh sample was prepared for each experiment.

Following the synthesis of the imine, the formation of the iminium ion was examined by the addition of an alkyl source. Initially BnBr and BnCl were used and the products of these reactions were analysed by ¹H NMR. In the case of

BnCl, there was little, if any, reaction evident. However, BnBr showed several new signals in the region of δ 10.02–7.58 ppm as well as a signal at 6.52. There was also some regeneration of the aldehyde (δ 8.95 ppm), presumably due to the presence of water that formed during the formation of the imine as well as ambient water. The aldehyde was the major product of this reaction.

Given the appearance of several products from this reaction, none of which were being formed to a large extent, an alternative, much stronger alkyl source, Me_3OBF_4 , was used in order to drive complete formation of the iminium species. This showed cleaner formation of what appeared to be both the (*E*)- and (*Z*)-isomers of the iminium ion, with signals at δ 7.85, 7.71 and 7.39 ppm (lower spectrum, Fig. 2.15). Again, there was also regeneration of the aldehyde.

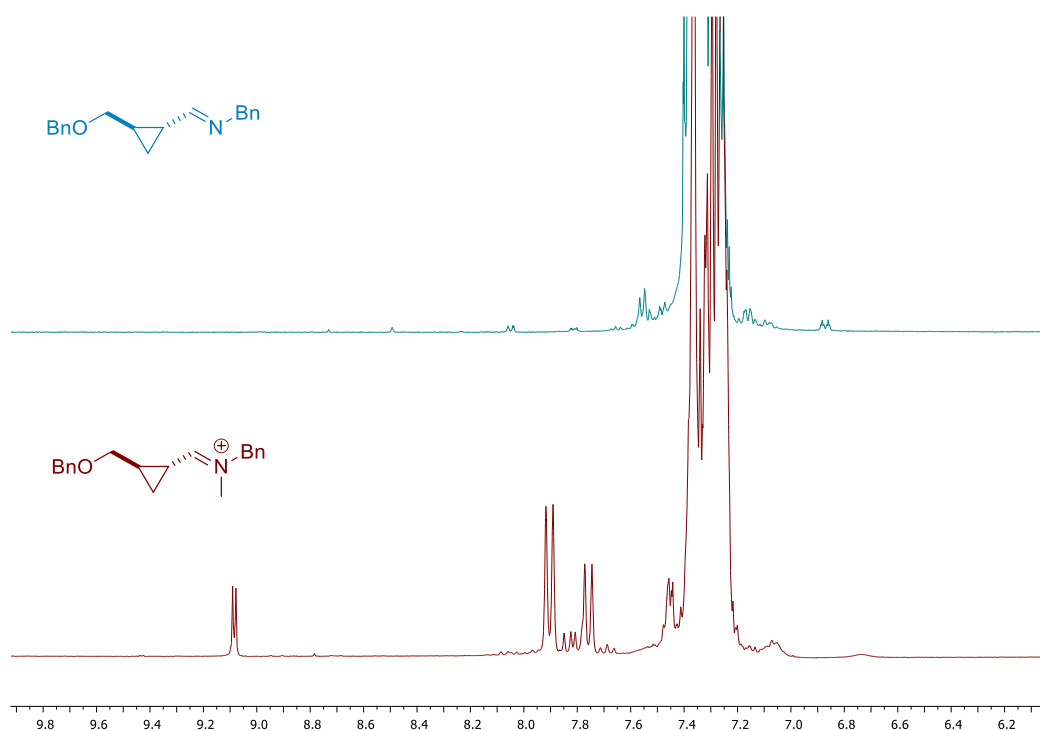

Fig. 2.15. Stacked spectrum of iminium region of benzylmethyliminium compound (red) and its parent imine (blue)

COSY analysis of this NMR showed coupling between the signals at δ 7.85 and 7.71 ppm (which appear to be isomers of the product) and a cyclopropane signal, indicating the formation of an iminium ion. Comparison with known iminium intermediates showed that this is the expected region for an iminium signal.⁷⁸

As there was a clearer sign of iminium formation in this case, the product of this reaction was directly used in the next step. It was treated with LiCl at 20 °C, over several hours, with ^1H NMR analysis every hour. Following this the reaction was heated to 60 °C and a ^1H NMR was taken after 1 and 2.5 h. These reactions all showed the same product, with little change after 1 h (upper spectrum, Fig. 2.16).

The signals at δ 7.85, 7.71 and 7.39 ppm decreased and the formation of a product was seen by the appearance of signals at δ 8.42, 8.24 and 7.54 ppm (upper spectrum, Fig. 2.16). However, there did not appear to be any coupling with these signals that would correspond to either of the desired products.

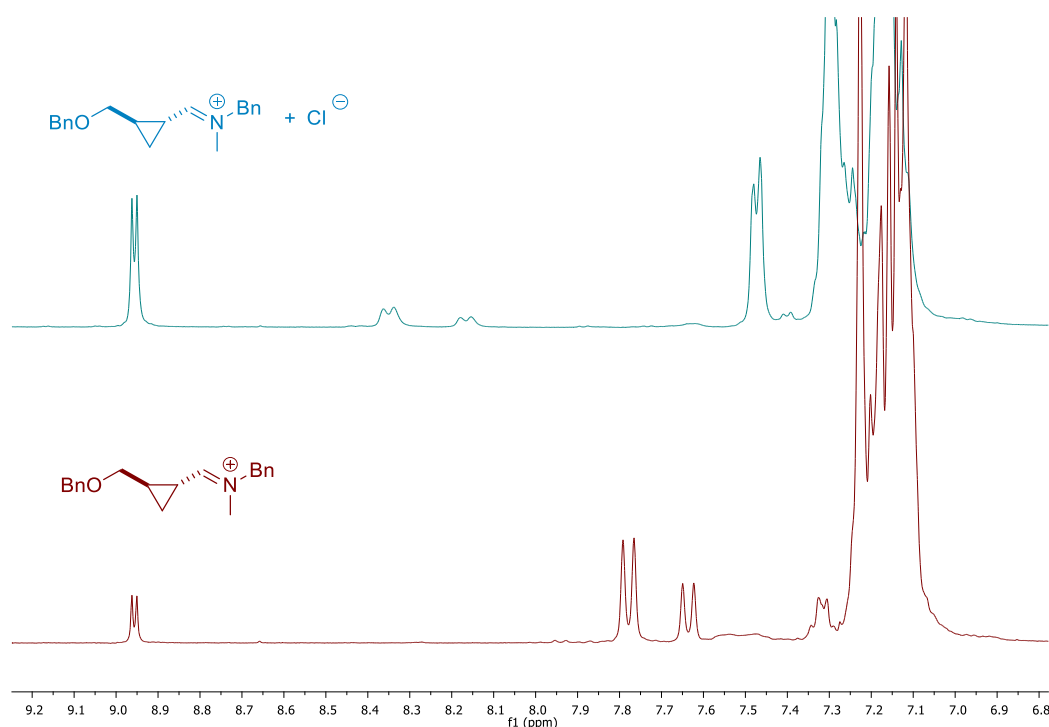

Fig. 2.16. Stacked spectrum of iminium region of benzylmethyliminium compound (red) and its reaction with Cl^- (blue)

Following this, the formation of the iminium ion of **18** using both **cat 1** and **cat 2** was investigated by treatment of **18** with 1 equiv. of each of these catalysts. The appearance of signals at δ 9.64, 9.63, 5.95 and 5.88 ppm in the case of **cat 2** (again these appeared to be isomers) and at δ 9.62 and 9.33 ppm in the case of **cat 1** indicated partial formation of iminium ions. There was again some regeneration of the aldehyde in both cases. These iminium salts were treated directly with various halide sources – benzyltriethylammonium chloride, LiCl, TBAB and

AlCl₃. Of these, the only evidence of reaction on ¹H NMR analysis was that between the iminium salt of **cat 1** and AlCl₃. However, this did not appear to be the desired product yet again by COSY analysis.

2.5.4 Conclusion of the project

At this point, a paper was published in which the desired ring-opening reaction was achieved using symmetrically disubstituted cyclopropylaldehydes with MacMillan-type catalysts and pyridinium chloride as a source of nucleophile (Scheme 2.33).⁶⁵ In this paper they obtained a crystal structure to show the formation of the iminium ion intermediate and provided several examples of the ring-opening reaction in which they subsequently dichlorinated the aldehyde using a source of Cl⁺.

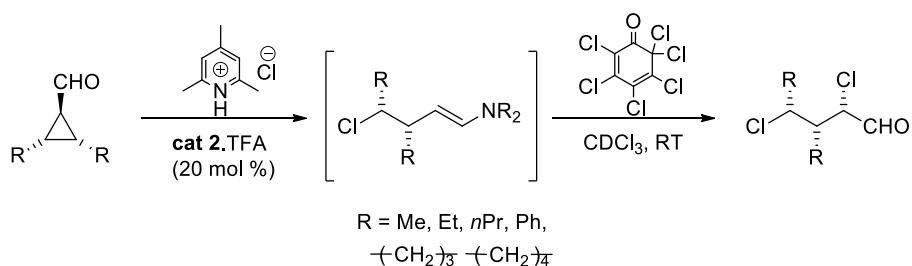

Scheme 2.33. Nucleophilic ring-opening reaction of cyclopropyl aldehydes

The key differences between the conditions we had tried and those in Scheme 2.33 are that the catalyst is at a higher loading, the electrophile is more soluble and that the cyclopropanes are symmetrically disubstituted. Following this publication, the reaction was attempted using our substrate **17** under identical conditions and resulted in recovery of starting material only. Unfortunately this shows that the substrate itself was resistant to this type of reaction and we had unwittingly chosen a poor substrate on which to base our initial screen.

Although several products were observed by TLC throughout this screening, it appears that **17** was resistant to nucleophilic ring-opening as performed by Sparr and Gilmour.⁴¹ This indicates that the aldehyde itself was degrading at some point in the reaction.

¹H NMR experiments showed formation of the iminium ion but the desired product was not found on addition of the nucleophiles. It is therefore possible that the substrate is less stable than those screened by Sparr and Gilmour. In addition,

the chloride source in the paper is more soluble than those chosen for our screening.

The work by Li *et al.* in 2009⁶⁵ shows that **17** reacts much slower than those screened by Sparr and Gilmour.⁴¹ which would explain the recovery of starting material. This could be because disubstitution of the successful substrates could perhaps force the groups around the ring into a more favourable position for attack of the nucleophile, while also increasing its stability. There is a possibility that **17** degrades in the presence of water, which would explain the counterintuitive requirement of 4 Å mol. sieves in the system developed by Li *et al.*⁶⁵ These could also possibly have provided a large surface area on which the reaction could take place and have allowed a substrate with low reactivity to show some activity.

Given that there would be little to add to this avenue of research if we continued, since any added value would be incremental rather than of true novelty, it was decided to conclude this project at 11 months and continue research in another area.

2.6 Conclusions II

Given the progress made in the generation of the iminium ion, and its subsequent reaction on addition of a nucleophile, the project was on track for more success. However, the nature of the substrate, in conjunction with the initial nucleophile choice, hindered progress at an early stage. Later choices of nucleophiles, with more soluble forms of halides being chosen towards the end, showed that, had the work not been published, the reaction was likely to be successful in the near future.

The current protocol by Sparr and Gilmour gives little room for significant novel improvements.⁴¹ However, work could be performed for improvements in terms of: the scope of the reaction, which could be expanded to a wider range of nucleophiles and unsymmetrical cyclopropanes; the *er* and *dr* values are good but could be improved and; the catalyst loading of 20% could be reduced further.

It is noteworthy that, although the authors intended to follow up on the synthetic utility of this reaction, they have not published any additional material on this subject, indicating that perhaps there are limitations in its scope.

Chapter 3 *Synthesis of Four- Membered Heterocycles*

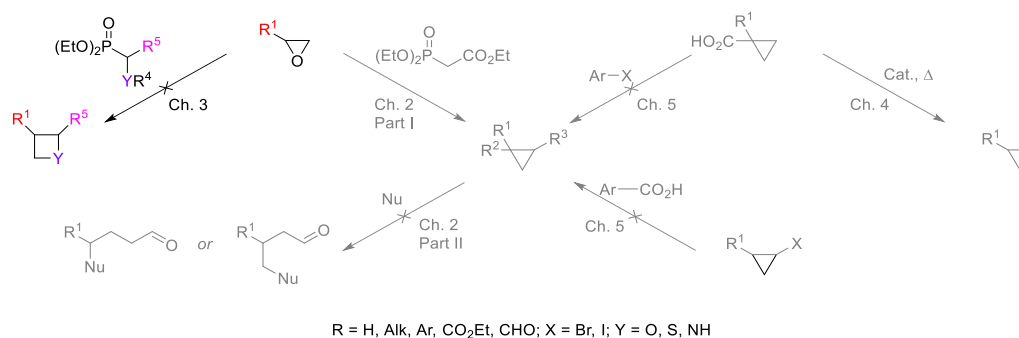

This chapter is a discussion on the extension of the Wadsworth–Emmons cyclopropanation (WEC) reaction, used to synthesise the substrates for Chapter 2, to the synthesis of four-membered rings, which are extremely valuable in the pharmaceutical industry for altering the pharmacokinetic properties of drugs.

3.1 Background

With experience in the group for the synthesis of three-membered rings by the WEC, it was thought that it may be possible to extend this methodology to the synthesis of four-membered heterocyclic rings such as oxetanes, azetidines and thietanes by extension of the chain length on the phosphonate. This would lead to the generation of phosphonate intermediates of the type **53** and **54** containing a heteroatom and with an increased chain length (Scheme 3.1), resulting in cyclisation to a four-membered ring.

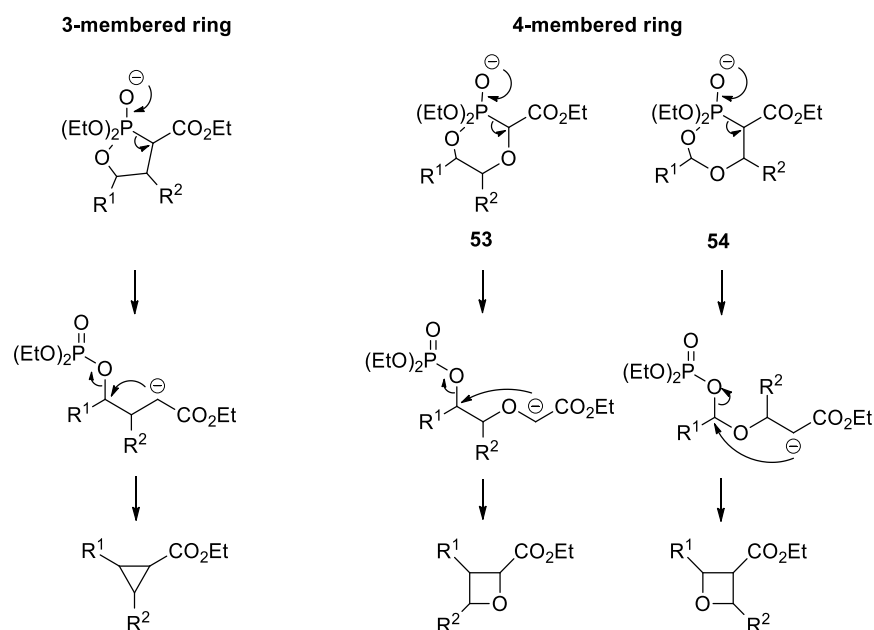

Scheme 3.1. Phosphonate intermediates for three- and four-membered ring synthesis

To generate this type of intermediate, it was decided to modify the phosphonate by incorporation of the heteroatom on the α -carbon. This would not allow the formation of intermediates such as **54** (Scheme 3.1, p. 74), but these could be investigated after optimisation of the reaction with readily available phosphonates (Scheme 3.2).

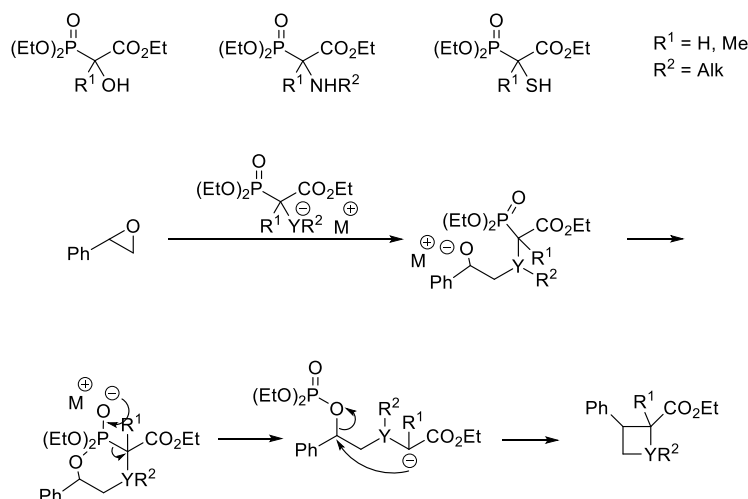

Scheme 3.2. Predicted mechanism for the extended Wadsworth–Emmons reaction

This would be an example of type I Anion Relay Chemistry (ARC), where the nucleophilic species contains the “linchpin”, which in this case is the phosphonate group.

These phosphonates could then be deprotonated for reaction with either epoxides or alkyl halides containing a protected alcohol (*e.g.* Fig. 3.1)

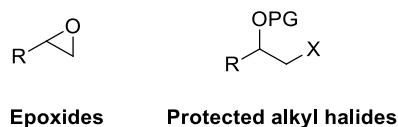
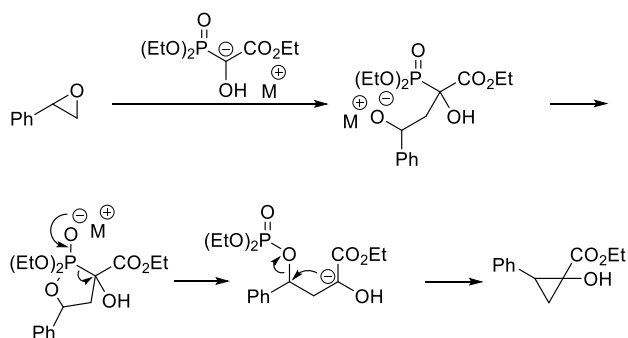

Fig. 3.1. Potential alkylating agents for reaction with phosphonates

It was desirable to screen phosphonates containing both a quaternary and a tertiary centre on the α -carbon due to potential problems that could be foreseen with either. Phosphonates containing a tertiary carbon centre could be deprotonated on the α -carbon rather than on the heteroatom, as the proton on this carbon would be extremely acidic due to the presence of the two adjacent electron-withdrawing groups (EWGs) (Scheme 3.3). Phosphonates containing a

quaternary centre would prevent this side-reaction but could be too sterically hindered or constrained for the formation of the four-membered ring.



Scheme 3.3. Possible side-reaction using tertiary phosphonates

The amine-substituted phosphonates should also contain a secondary amine to prevent similar side-reactions from further deprotonation of the amine rather than the alcohol.

3.2 Results and Discussion

3.2.1 Intermolecular route

3.2.1.1 Synthesis of starting materials from diethyl phosphite

The phosphonate starting materials **55** and **56** were formed *via* a straightforward reaction between diethyl phosphite and the appropriate aldehyde or ketone (Scheme 3.4).⁸⁵ These were purified by flash column chromatography.

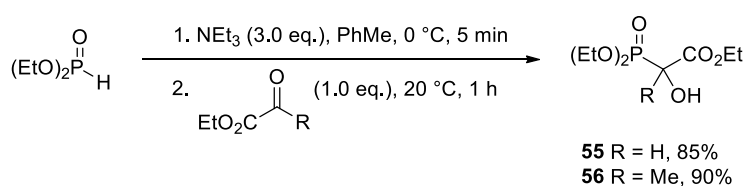

Scheme 3.4. Synthesis of phosphonates from diethyl ether

Attempts were also made to synthesise amine-substituted phosphonates that were equivalent to the alcohol-substituted phosphonates **55** and **56**. Initially the imines **57** and **58** were synthesised from ethyl glyoxalate and ethyl pyruvate respectively (Scheme 3.5).

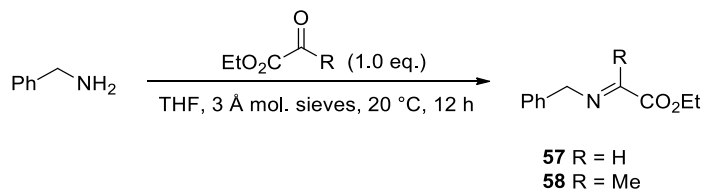

Scheme 3.5. Synthesis of benzylimines **57** and **58**

Unfortunately, all attempts to purify these compounds by flash column chromatography or distillation resulted in degradation of the product, as would be expected for a reactive imine. The crude product was therefore used directly in reaction with diethyl phosphite in the same manner as shown in Scheme 3.4. However, this did not give the desired product.

The reaction was then attempted again using a Lewis acid in order to drive it forward. In this case, the reagents were all added at once rather than performing the imine (Scheme 3.6). It was hoped that this would reduce the number of side-products and degradation products that were seen previously in the formation of the imine and would thus lead to a cleaner reaction. Again, however, this reaction

did not proceed. These types of phosphonates were therefore disregarded until a later stage in order to move the project forward as quickly as possible.

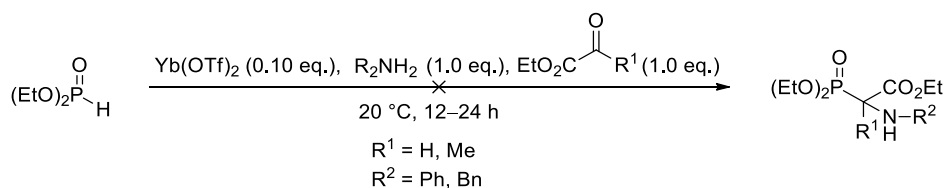

Scheme 3.6. Attempted synthesis of amine-substituted phosphonates using a Lewis acid

3.2.1.2 Attempts to synthesise sulfur-containing phosphonates

With a view to forming thietanes, the synthesis of phosphonate **59** was attempted by the method of Mikołajczyk *et al.* for the addition of elemental sulfur to phosphonate carbanions (Scheme 3.7).⁸⁶

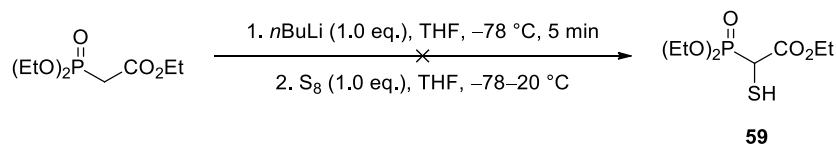

Scheme 3.7. Attempted synthesis of thiol phosphonate **59**

This reaction did not proceed using triethyl phosphonoacetate (TEPA). Mikołajczyk *et al.* showed it to work with Ph or Me substitution or an unsubstituted α -carbon but no attempt was made using an ester as the anion stabilising group (ASG).⁸⁶ It has also since been shown to work with a range of aryl-substituted phosphonates (none of which contained an EWG).⁸⁷ It appears that the ester group is too strongly electron-withdrawing for the reaction.

Following this, an alternative route was explored in which compound **60**, which has been reported as an unisolated intermediate,⁸⁸ would be synthesised from **61**⁸⁹ (Scheme 3.8). Again, however, isolation of the intermediate **60** was unsuccessful, with the reaction continuing to completion to yield PPh_3S instead.

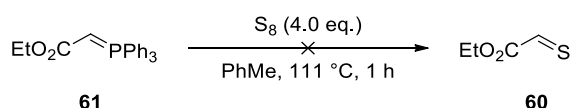

Scheme 3.8. Attempted formation of **60**

With few other literature examples of the synthesis of sulfur-containing phosphonates, it was decided to focus instead on the oxygen-containing phosphonates **55** and **56**.

3.2.1.3 Screening of conditions for intermolecular oxetane formation

With two phosphonate starting materials in hand which could potentially be used for oxetane synthesis, attention was now focussed on the desired reaction. If the reaction proceeds along the proposed route there are four potential products for each phosphonate (Scheme 3.9). Products **62** and **63** will be formed if the oxyanion attacks, as expected, at the least hindered site of the epoxide ring, followed by attack of the resulting oxyanion on the phosphonate group (Route 2a, Scheme 3.9). Alternatively attack at the more hindered benzylic site of styrene oxide would give products **64** and **65** (Route 1a, Scheme 3.9). If the oxyanion generated from the initial nucleophilic attack reacts with the ester rather than the phosphonate, resulting in loss of EtOH, the dioxane products **66–69** will be formed (Routes 2b and 1b, Scheme 3.9). In the absence of any electronic interactions which constrain rotation around bonds, Routes 1b and 2b can be predicted to be less favourable than Routes 1a and 2a, due to the stronger P–O bonds being formed *via* Routes 1a and 2a.

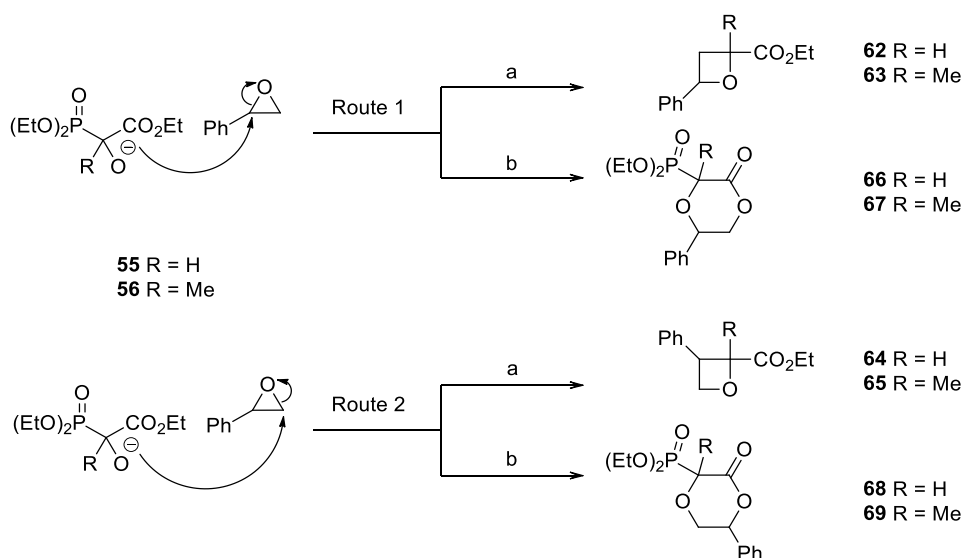

Scheme 3.9. Potential products of intermolecular reaction

Both phosphonates **55** and **56** were screened against a range of bases (Table 3.1).

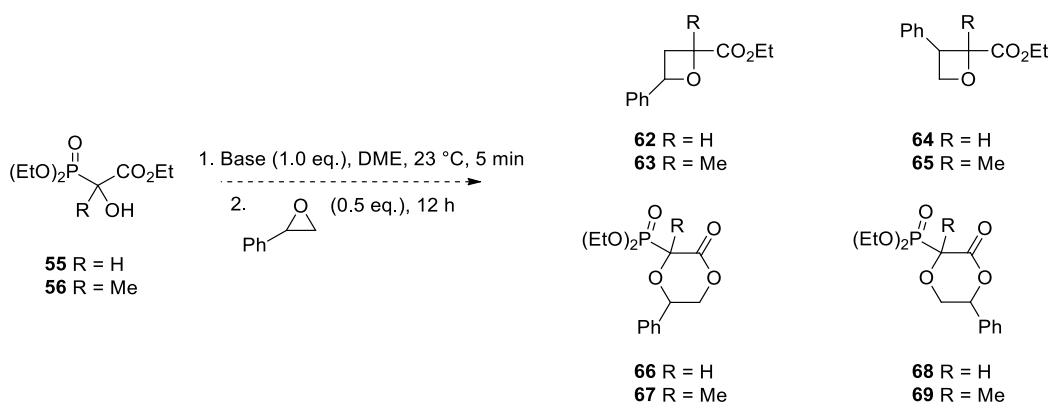
Table 3.1. Screening of bases on phosphonates **55** and **56**

Entry	R	Base	Temperature (°C)
1	H	<i>n</i> BuLi	70
2	H	<i>n</i> BuLi	130
3	H	NaH	130
4	H	MeMgBr	130
5	Me	<i>n</i> BuLi	70
6	Me	<i>n</i> BuLi	130
7	Me	NaH	130
8	Me	MeMgBr	130

The reactions were worked up and the crude reaction mixtures were analysed by ^1H , COSY and ^{31}P NMR experiments in CDCl_3 . A literature search of similar oxetanes gave an estimated range for the protons on the oxetane ring of between 4.5–6.0 ppm for **64** and **65** and between 4.5–6.5 ppm for **62** and **63**.⁹⁰ The only promising signals from this screening were seen in the reaction with MeMgBr and **56** (Entry 8, Table 3.1), which showed multiplets at 4.80 and 3.50 ppm. However, partial purification showed that this compound did not contain either a methyl group or an ethyl group nor any signals above 5.0 ppm, indicating that this was not the oxetane.

Following this, both **55** and **56** were treated with each base at 130 °C in ethylene glycol dimethyl ether (DME) and were analysed by ^1H NMR in d_6 -DMSO for the formation of the oxyanion. This was evident for each as judged by a shift in the ^1H NMR signals and there was no degradation observed.

With the intention of reducing the number of potential side-products and alternative routes, it was decided to preform the intermediate phosphonates **70** and **71** and to perform the reaction along an intramolecular route (Fig. 3.2).

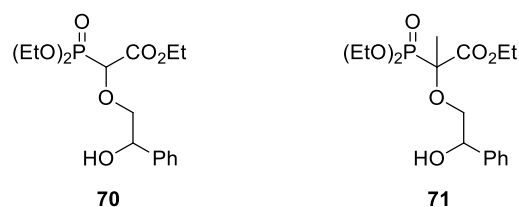
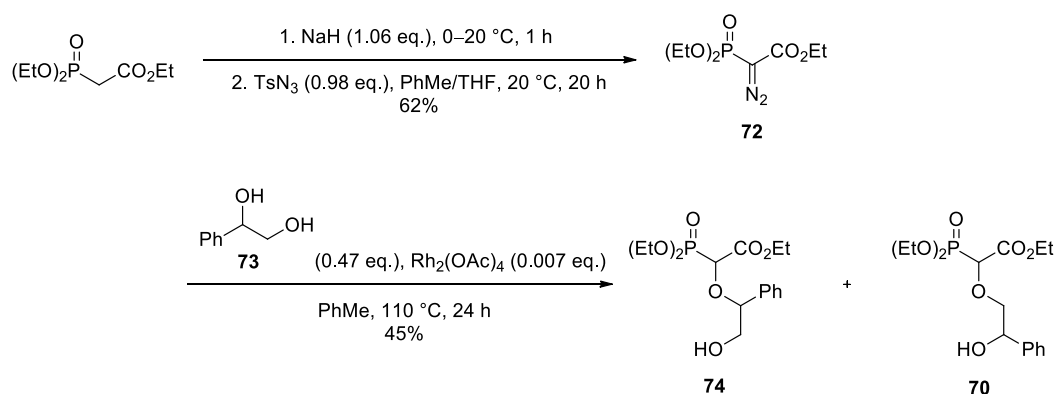

Fig. 3.2. Intermediate phosphonates **70** and **71**

3.2.2 Intramolecular route

3.2.2.1 Synthesis of starting material from diazophosphonates

Initial attempts to synthesise phosphonate **70** involved a simple alkylation reaction by deprotonation of phosphonate **55** with NaH. However, this returned unreacted starting materials. Following this, **70** was successfully formed by a strategy based on the reported $\text{Rh}_2(\text{OAc})_4$ mediated reactions of diazo compounds with alcohols to form an ether.⁹¹ These proceed *via* formation of a carbenoid with the extrusion of N_2 . Using ethyl 2-diazo-2-(diethoxyphosphoryl)acetate (**72**), the reaction was initially attempted using unprotected diol **73**⁹² (Scheme 3.10). However, this resulted in an inseparable mixture of products **74** and **70**.



Scheme 3.10. Attempted synthesis of phosphonate **70**

Following this, the monoprotected diol **75** was synthesised *via* **76**. This allowed the isolation of the TBS-protected phosphonate **77** (Scheme 3.11), which could subsequently be deprotected to give **70**.

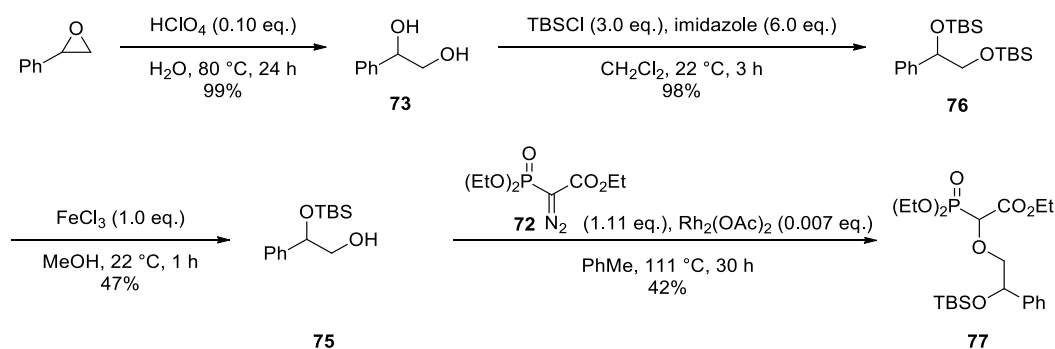

Scheme 3.11. Synthesis of TBS-protected phosphonate **77**

The deprotection of **76** was initially attempted with a TFA/H₂O mix but this did not proceed. It was found that FeCl₃ allowed selective deprotection of the primary alcohol, although, when left for longer than 1 h, deprotection of the secondary alcohol was also evident. It was therefore necessary to stop the reaction after 1 h with a low yield of 47%.

Deprotection of the secondary alcohol of **77** was first attempted using TBAF at 0 °C. It was thought that deprotection in this way could allow the formation of either the deprotected alcohol **70** or the oxetane **64** (Scheme 3.12).

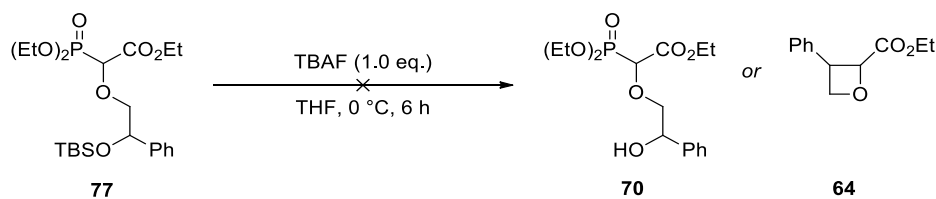

Scheme 3.12. Our first attempted deprotection of **77**

This reaction showed no evidence of reaction by TLC after 6 h so the reaction was allowed to warm to room temperature and was stirred for 7 days (following by TLC). This again showed no reaction and analysis of the crude ¹H NMR showed that neither product was formed in detectable amounts.

Following this, the deprotection was carried out using FeCl₃ as before. This allowed access to the product, albeit in a low yield of 26%. This yield was greatly improved on by the *in situ* formation of HF, which gave the deprotected product **70** in a high yield of 97% (Scheme 3.13).

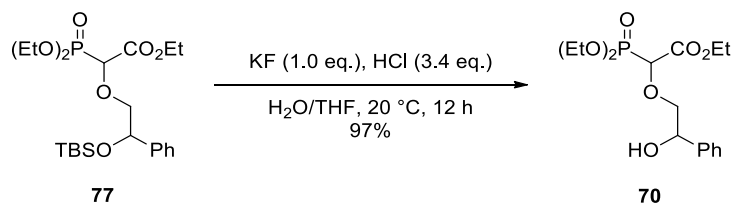

Scheme 3.13. Optimised deprotection of **77**

Unfortunately, as the synthesis of this phosphonate was achieved from **72**, the possibility of forming the quaternary phosphonate **71** was removed by this route. The alternative of starting from phosphonate **56** and alkylating was also explored, but again this returned only starting materials.

The synthesis of amine-substituted phosphonate **78** (Fig. 3.3) was also attempted from **72** with benzylamine under the same conditions. However, no reaction occurred in this case.

3.2.2.2 Attempts to synthesise amine-substituted phosphonates

An alternative method was therefore employed in which the phosphonate **79** (Fig. 3.3) was synthesised from diethyl phosphite according to the literature procedure.⁹³

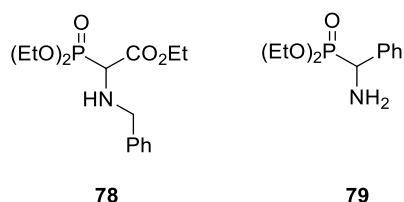
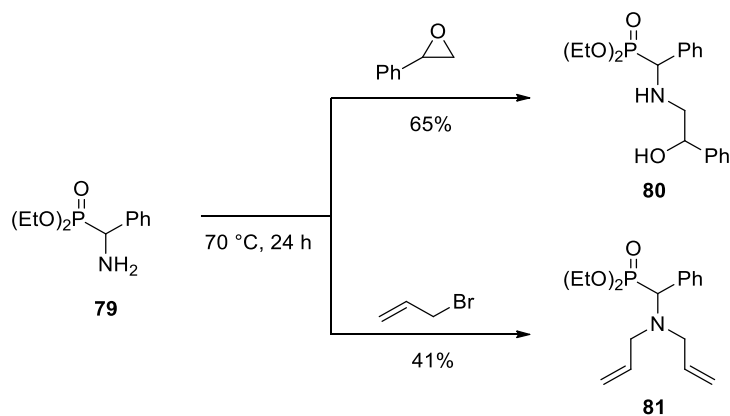

Fig. 3.3. Amine-substituted phosphonates **78** and **79**

The amine phosphonate **79** was further functionalised by reaction with either an alkyl halide or an epoxide (Scheme 3.14). The reaction of **79** with styrene oxide allowed access to the desired phosphonate **80**.⁹³ However, reaction of **79** with allyl bromide gave the dialkylated product **81** rather than the monoalkylated product.



Scheme 3.14. Alkylation of amino phosphonate

Attempts to further alkylate phosphonate **81** to form the desired phosphonate **82** (Fig. 3.4) were unsuccessful and returned only starting materials, presumably due to steric hindrance from the bulky substituents on nitrogen.

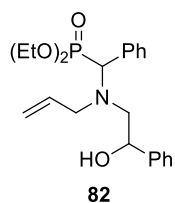
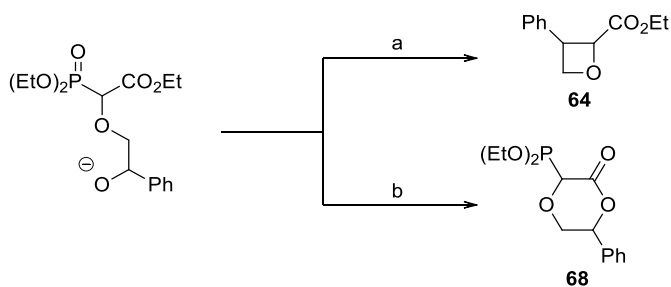

Fig. 3.4. Desired amine-substituted phosphonate **82**

3.2.2.3 Screening of conditions for intramolecular oxetane formation

With phosphonate **70** in hand there are only two potential products if the reaction proceeds along the desired route (Scheme 3.15).



Scheme 3.15. Potential products of intramolecular reaction

70 was screened over a range of reaction conditions, varying base, temperature, solvent and time (Table 3.2). These experiments were analysed by ^1H , COSY, and ^{31}P NMR in CDCl_3 .

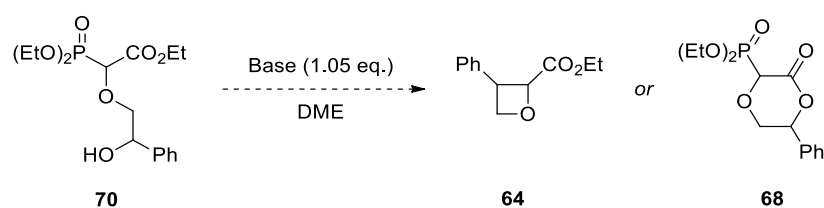
Table 3.2. Screening of intramolecular reaction

Entry	Base	Temperature (°C)	Solvent	Time (h)
1	NaH	20	DME	24
2	NaH	80	DME	12
3	NaH	-78-20	DME	24
4	NaHMDS	-78-20	DME	24
5	NaH	20	DME	2
6	<i>n</i> BuLi	20	DME	2
7	MeMgBr	20	DME	2
8	NEt ₃	20	DME	2
9	NaHMDS	20	DME	16
10	<i>n</i> BuLi	20	DME	16
11	LDA	20	DME	16
12	NaHMDS	20	THF	16
13	<i>n</i> BuLi	20	THF	16
14	LDA	20	THF	16

The majority of these reactions showed formation of a small amount of another phosphonate with multiplets at 5.70 and 5.50 ppm ($J_{\text{PH}} = 19.8$ and 18.9 Hz for both diastereomers) which were coupled to signals at 4.26 and 3.64 ppm (entries 1, 3-7, 9, 11-14, Table 3.2) (Fig. 3.5). Those reactions run in THF and/or with NaHMDS all gave this product. The reaction with NaH, in which the temperature was brought up to 80 °C (entry 2) resulted in an extremely unclear ¹H NMR which could not be read satisfactorily. However, all other NaH reactions gave this product also.

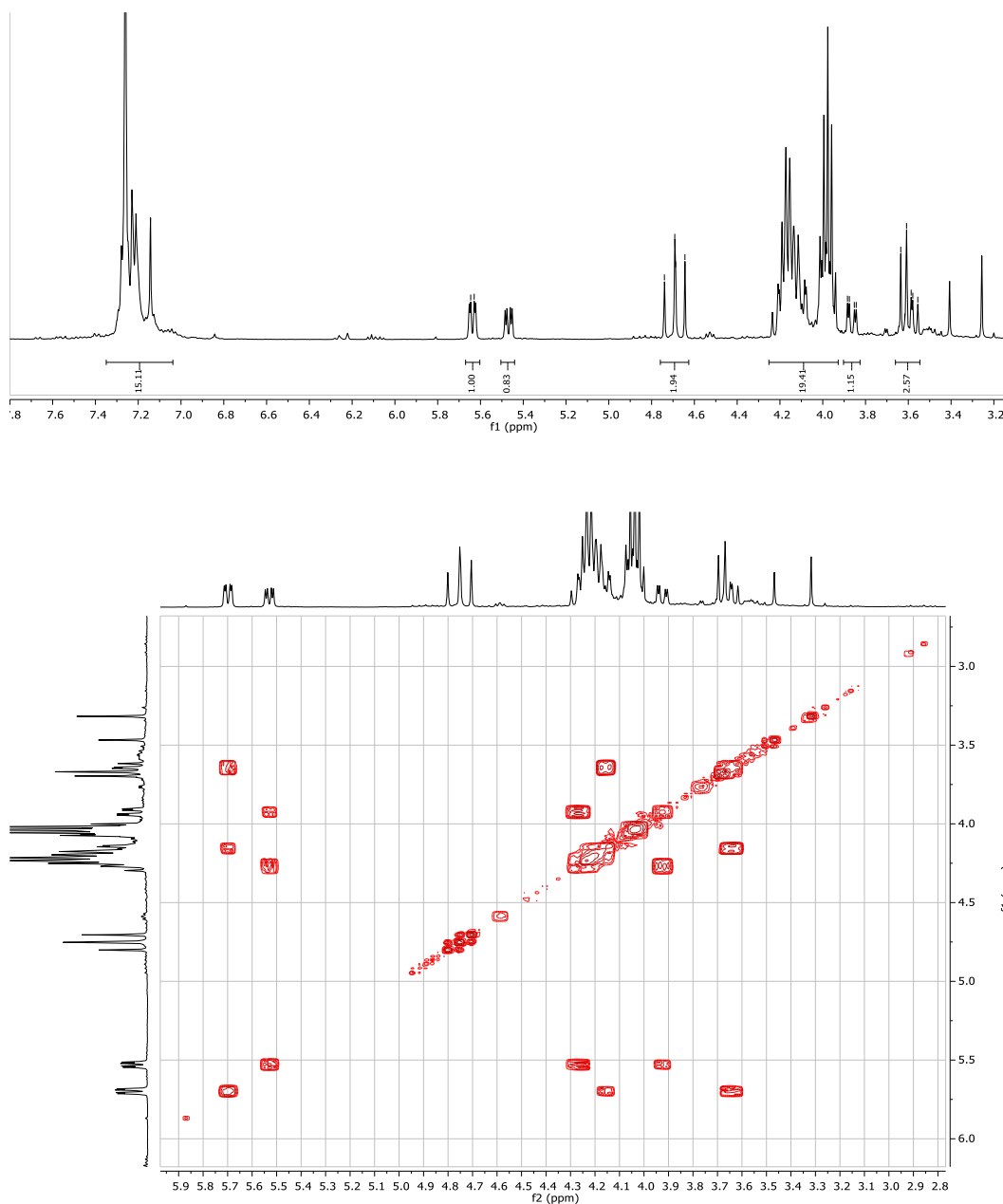

Fig. 3.5. Reaction of **70** with base

The reaction with MeMgBr (entry 7) showed another promising product with multiplets at 5.88, 5.00 and 2.24 ppm, which coupled to one another (Fig. 3.6). The signal at 2.24 ppm would appear to be too low for the oxetane ring and partial purification of this product showed that the aromatic region did not correspond to what would be expected, instead containing six distinct proton signals. There was no phosphorus present according to ^{31}P NMR. Therefore, the large coupling constants of 17.2 for the ddq at δ 5.00 ppm are likely, along with the high chemical shift, to indicate the presence of an alkene.

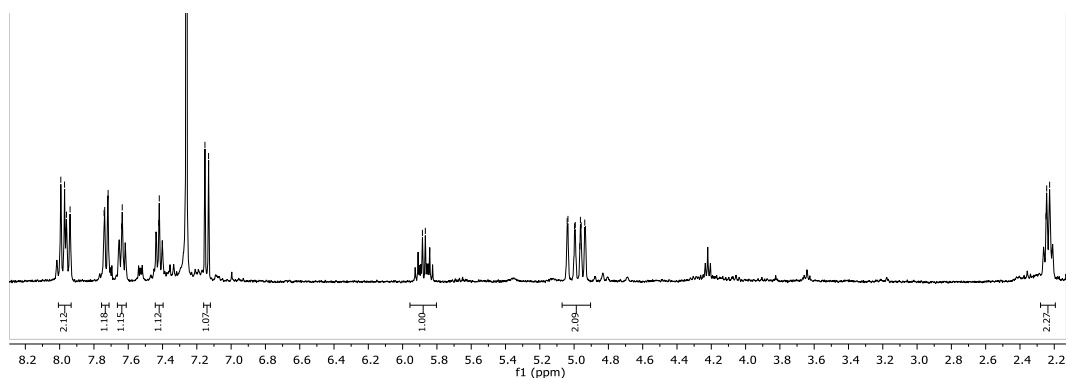

Fig. 3.6. Reaction of **70** with MeMgBr

This reaction also showed formation of another phosphonate (multiplet at 5.40 ppm) which was also seen in the reaction with NaH run between -78 – 20 °C (entry 3).

Reaction with *n*BuLi (entry 10) and NaH in DME for 2 h (entry 5) also gave a small amount of another product which showed multiplets at 6.30 and 6.15 ppm (Fig. 3.7). However, these coupled to a signal at 2.12 ppm which would be very far out of the predicted range for the oxetane ring.

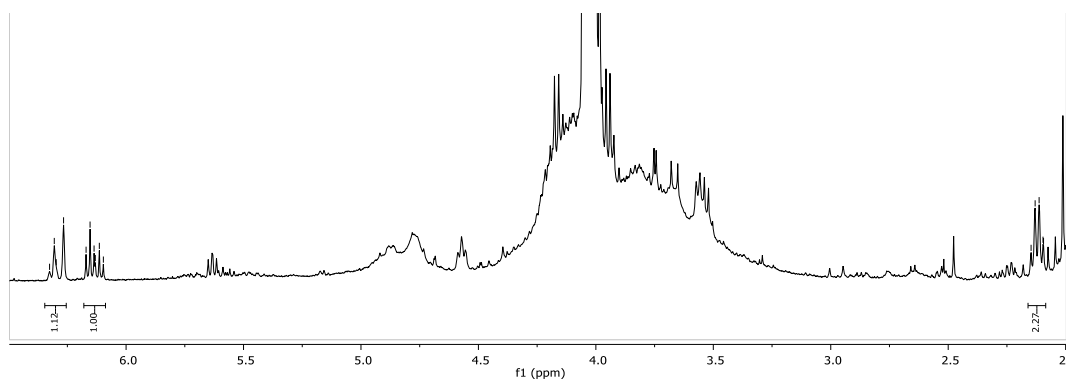

Fig. 3.7. Reaction of **70** with *n*BuLi

The reaction with NEt_3 returned starting material only (entry 8).

At this point, with no evidence of the reaction proceeding in the desired direction or with a high yield of any of the products (all reactions returned starting material as the major component), as well as the difficulties encountered in the synthesis of nitrogen- and sulfur-containing phosphonates, it was decided that this project

was unlikely to generate positive results and that it would be advisable to begin a new project.

3.3 Conclusions

Although this reaction appeared to have potential for the synthesis of valuable four-membered heterocycles, the lack of success indicates that there is a fundamental issue with this reaction. In terms of the intermolecular reactions, this could have been a simple issue with optimal dispersion of the reagents. However, this seems unlikely and, given that phosphonate **70** also failed to form the oxetane, it does not appear to be the case. Although ^1H NMR experiments showed formation of the alkoxide, the necessity to preform **70** through a carbene reaction with **72**, rather than alkylation using styrene oxide or an alkyl halide does indicate that there are issues with the nucleophilicity of this alkoxide.

The evidence of formation of other phosphonates in some reactions indicates that the base is deprotonating at some position on the phosphonate. This could be the alcoholic proton, the benzylic proton or the α -proton. More nucleophilic bases, such as $n\text{BuLi}$ or MeMgBr , could have added into the phosphonate or ester rather than acting as a base, which could explain the unique products formed from these reactions. Once deprotonated, it seems highly likely that the oxyanion would attack on phosphorus and it is also possible that one of the phosphonates is the cyclised intermediate but that there has been no collapse of this intermediate into the desired oxetane ring. Perhaps the larger ring-size does not allow this collapse to occur.

With more work and time, it could be possible to push this reaction forward. One way in which to examine the viability of the collapse of the six-membered ring would be to preform a cyclic intermediate in the same manner as has been done for WEC reactions⁴⁸ (Scheme 3.16). This could then be treated with NaOEt to ensure formation of the desired alkoxide and thus to determine the point at which the reaction is being shut down – *i.e.* at deprotonation or at the six-membered ring.

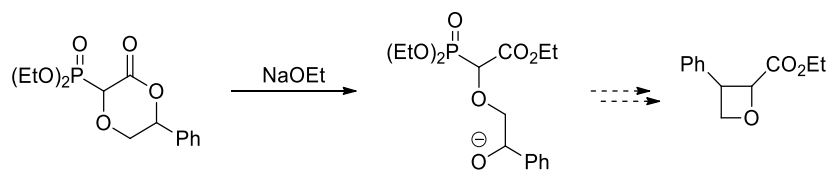

Scheme 3.16. Potential route for investigation of oxetane formation

Chapter 4 *Protodecarboxylations of Cyclopropanecarboxylic Acids*

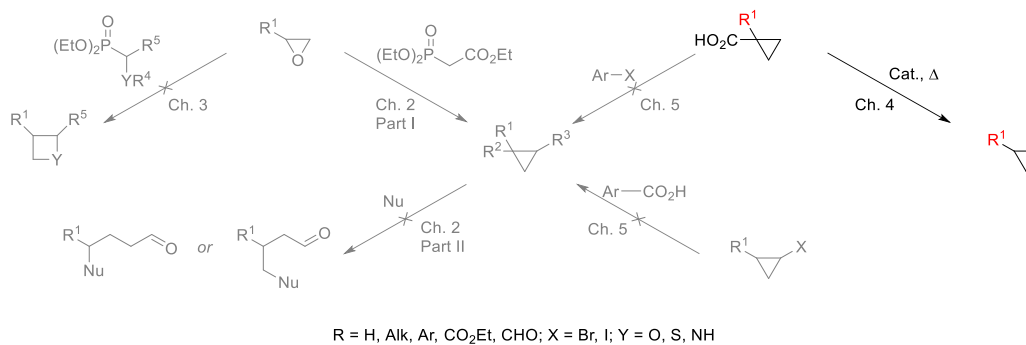

This chapter describes the development of a metal catalysed protodecarboxylation of cyclopropanes, with the aim of incorporating this method into a cross-coupling procedure. As cyclopropanes have sp^2 -like character and have been said to possess aromatic-like properties, the known methods for decarboxylation of benzoic acids were used as a starting point for the development of the reaction.

4.1 Background

4.1.1 Decarboxylation of cyclopropanecarboxylic acids

In order to develop a cross-coupling reaction, it was necessary to first achieve the protodecarboxylation of cyclopropanecarboxylic acids. A search of the literature revealed that there was no reported metal catalysed decarboxylation of cyclopropanecarboxylic acids. There are three major decarboxylative methods used currently – thermal decarboxylation, the Hunsdiecker reaction⁹⁴ and the Barton decarboxylation reaction.⁹⁵

Thermal decarboxylation of cyclopropanes was first reported by Perkin in 1884.^{15,96} There have since been several reports of thermal decarboxylation of cyclopropanecarboxylic acids.⁹⁷ However, these reactions generally require temperatures in excess of 200 °C in addition to the presence of activating groups. This is comparable to the thermal decarboxylation of benzoic acids. O'Bannon and Dailey achieved the decarboxylation of sodium salts of cyclopropanecarboxylic acids^{97f} generated *via* hydrolysis of the corresponding ester, at 80 °C. This temperature is abnormally low due to the presence of an electron-withdrawing nitro substituent geminal to the carboxylic acid and the preformed anion. However, the triphenylated compound **83** (Fig. 4.1) did not decarboxylate until 290 °C,^{97d} while 1-phenylcyclopropanecarboxylic acid **84** (Fig. 4.1) required a temperature of 350 °C, along with a pressure of 40 mmHg.^{97c}

Thermal decarboxylation alone would therefore be unsuitable for a cross-coupling procedure as the temperatures required are generally too high.

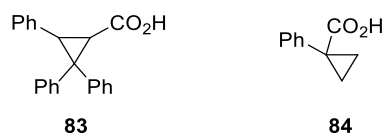
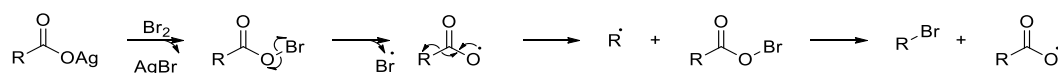

Fig. 4.1. Cyclopropanecarboxylic acids **83** and **84**

The radical-mediated decarboxylation of silver salts of carboxylic acids is commonly referred to as the Hunsdiecker reaction. The first example of this type of reaction was reported by Borodine in 1861.⁹⁸ However, due to the greater contribution of Hunsdiecker and Hunsdiecker to the development of the reaction, it is generally named for them. The reaction requires the formation of a metal salt, usually silver or mercury, which forms an acyloxyhalide that decomposes with loss of CO₂ *via* a radical-mediated process, followed by reaction with a halogen donor to afford the alkylhalide (Scheme 4.1).



Scheme 4.1. Mechanism for Hunsdiecker decarboxylative halogenations reaction

This type of reaction has been used for the decarboxylation of cyclopropanecarboxylic acids.⁹⁹ However, the reaction affords a cyclopropylhalide, has been reported to be explosive^{99a} and is generally believed to proceed *via* a radical mechanism, meaning it is not ideal for the development of a cross-coupling reaction.

Finally, the Barton decarboxylation reaction has also been frequently used for the decarboxylation of cyclopropanecarboxylic acids.¹⁰⁰ This also proceeds *via* a radical-mediated mechanism (Scheme 4.2), generates large amounts of tin waste and requires expensive prefunctionalisation of the acid. Again, these are not suitable conditions for the development of the cross-coupling reaction.

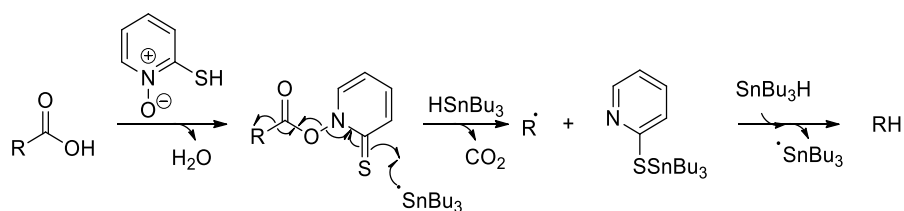

Scheme 4.2. Mechanism for the Barton decarboxylation reaction

Excepting these three methods, there is little precedent in the literature for the decarboxylation of cyclopropanecarboxylic acids. It was therefore evident that, before embarking on the cross-coupling, a metal catalysed protodecarboxylative process for cyclopropanes must be developed that would be applicable to a variety of cyclopropanes with relatively mild reaction temperatures, analogous to that known for benzoic acids (Section 4.1.3).

Given the similarities between cyclopropanes and aromatics (Section 1.2.1, p. 14), it was elected to begin the investigation by a similar process to that used for arylcarboxylic acid protodecarboxylation, on which there have been many studies.

4.1.2 Thermal decarboxylations of arylcarboxylic acids

The mechanism of simple thermal decarboxylation of arylcarboxylic acids has been investigated as early as the 1930s. Initial investigations were focussed on the decarboxylation of quinolines in a series of publications named “Mechanism of Decarboxylation”.¹⁰¹ The authors initially examined the reactions of quinaldinic and *iso*quinaldinic acids and proposed the formation of a zwitterion intermediate (Fig. 4.2), which was also favoured by Doering *et al.*¹⁰²

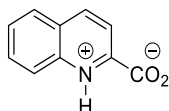

Fig. 4.2. Quinaldinic acid zwitterion intermediate

4.1.3 Copper-mediated decarboxylation of arylcarboxylic acids

4.1.3.1 The role and nature of copper in the reaction

The first studies dedicated to the copper mediated decarboxylation of arylcarboxylic acids were performed by Nilsson in 1966.¹⁰³ He likened the

process to the Ullmann reaction and hypothesised that it would therefore proceed by a stepwise mechanism. His group continued to work on these reactions, using 0.5–1.0 equiv. of copper(I) oxide in quinoline in the presence of aryl iodides, and observed low yields of the coupled products, with the major product being the protodecarboxylated arene.¹⁰⁴ From his results he postulated the formation of an Ar–Cu σ -bond, which was corroborated by Cairncross *et al.* by the isolation of **89**¹⁰⁵ (Scheme 4.3).

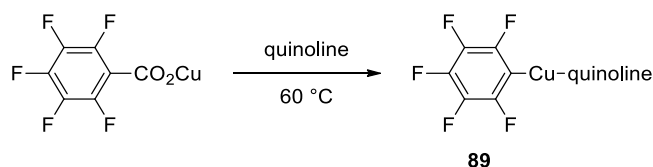

Scheme 4.3. Decarboxylation of copper pentafluorobenzoate

Cohen *et al.* also favoured the formation of an arylcopper intermediate and suggested the role of copper in the reaction to be similar to that which it plays in the Ullmann biaryl coupling and in the exchange reaction of aryl and vinyl halides with copper(I) salt anions, due to the close relationship between the three reactions.¹⁰⁶ This would imply that the reaction would proceed by oxidative addition with insertion of copper into the C–C bond (Scheme 4.4), in a similar manner to the current widely accepted mechanism shown in Section 4.1.3.4 (p. 96).

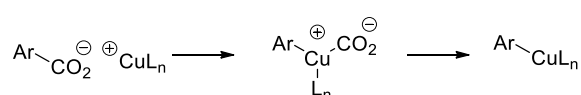

Scheme 4.4. Proposed mechanism for decarboxylation of aryl carboxylic acids

Thus, the charge is not delocalised into the π -system, but the decrease in oxidation number of the carbon atom that is bearing the carboxylate can be stabilised.

Nilsson screened a range of copper sources for the decarboxylation of 2-nitrobenzoic acid.^{104c} These showed that the copper source had little effect on the reaction. This was rationalised by Cohen *et al.*, who observed that copper(I) and copper(II) salts catalytically effected the decarboxylation faster than copper metal, with excellent yields when the reactions were performed under a nitrogen

atmosphere.¹⁰⁷ It was found that the active copper catalyst was copper(I). The ability of copper(II) to catalyse the reaction equally well was explained by its rapid reduction to copper(I), as observed by ESR. A nitrogen atmosphere was thus necessary to prevent oxidation of active copper(I) to copper(II).

4.1.3.2 The role of the solvent

Basic solvents were found to be best for the reaction, with quinoline and pyridine performing most effectively of those screened.^{104c} Pyridine was found to be more effective than quinoline as solvent, possibly due to reduced steric hindrance for complexation of copper(I).¹⁰⁶

Nilsson noted that there were still large amounts of ArH obtained under anhydrous conditions, which implied the presence of another proton source – *i.e.* the solvent or the carboxylic acid.^{104c} Cohen *et al.* confirmed this by running the reaction in quinoline-d₂. A reduced yield was obtained, indicating that the proton source under anhydrous conditions could come from the solvent.¹⁰⁶ The availability of other protons on the ring of quinoline-d₂ would still allow some product to be formed.

Chelating agents such as 2,2'-bipyridyl and 1,10-phenanthroline considerably increased the rate of reaction and also allowed the reaction to proceed in non-coordinating solvents.¹⁰⁷ This was the first time this effect had been reported and it has since been confirmed in more recent publications.¹⁰⁸

4.1.3.3 Radical vs non-radical mechanism

Cohen *et al.* also examined the kinetics of the decarboxylation of activated (*i.e.* containing EWGs) and non-activated copper benzoates.¹⁰⁶ They confirmed that the reaction was unlikely to proceed *via* a radical mechanism as decarboxylation of **90** gave the simple protodecarboxylated product **91** rather than the radical product **92** which had been observed previously (Scheme 4.5).

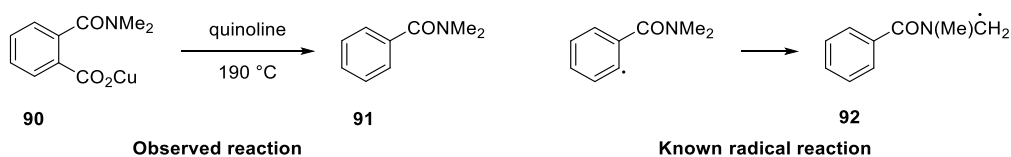

Scheme 4.5. Known radical reaction and non-radical reaction observed by Cohen *et al.*

Gooßen *et al.* have shown that the addition of 2,2,6,6-tetramethyl-1-piperidinyloxy (TEMPO) to the reactions had no effect, providing more evidence for a non-radical mechanism.¹⁰⁹

4.1.3.4 The effect of substituents

Gooßen *et al.* have extensively developed the copper catalysed decarboxylation reaction since 2006, when they published the first synthetically useful procedure for the decarboxylative cross-coupling of benzoic acids, with the decarboxylation step mediated by Cu₂O and the subsequent coupling step mediated by Pd(acac)₂.¹¹⁰ It has been observed that the presence of an EWG, or another group that can stabilise the developing negative charge, in the *ortho*-position – dubbed the ‘*ortho* effect’ – is necessary for the decarboxylation to proceed at reasonable temperatures. Gooßen *et al.* have shown that copper can also be used to catalyse *meta*- and *para*-substituted benzoic acids.¹⁰⁹ They found that inductively electron-withdrawing groups that could stabilise the charge along the σ -backbone had a much larger effect than long-range mesomeric effects.

Benzoic acids with electronegative *ortho*-substituents had an early transition state, with short Ar–C bonds and long Ar–Cu bonds, while all others had a late transition state, with long Ar–C bonds and short Ar–Cu bonds, and were therefore endothermic. By DFT measurements on the decarboxylation of 2-fluorobenzoic acid, copper was found to be in a distorted tetrahedral environment in the transition state (Scheme 4.6).

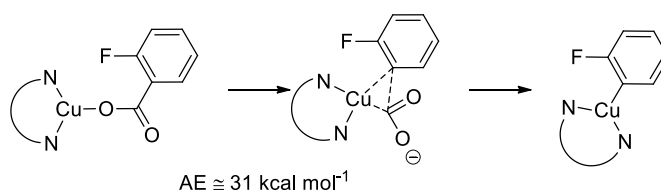

Scheme 4.6. Mechanism for copper-catalysed decarboxylation of 2-fluorobenzoic acid

Silver was found to catalyse the decarboxylation of *ortho*-substituted benzoic acids very efficiently, with a 50 °C reduction in temperature.¹¹¹ However, this system gave none of the desired product for *para*- or *meta*-substituted benzoic acids, making it less generally useful than copper. Silver-catalysed

decarboxylative cross-couplings were also published around the same time by the Larrosa group.¹¹²

The *ortho* effect was also investigated by Xue *et al.* by DFT measurements on copper- and silver-catalysed decarboxylations of benzoic acids.¹¹³ They were interested in the difference between palladium-catalysed decarboxylations, which are driven by electron-rich substituents that, in contrast, can retard copper- and silver-catalysed reactions. DFT measurements led them to conclude that, in general terms, substituents that destabilise the starting complex due to steric interactions, such as NO₂, halide or OMe groups, push the reaction forward, as do substituents that can stabilise the transition state – *e.g.* NO₂ can coordinate to the metal. Conversely, substituents that stabilise the starting complex hinder the reaction. In their proposed mechanism the proton source is a second benzoic acid molecule that re-enters the catalytic cycle (Scheme 4.7).

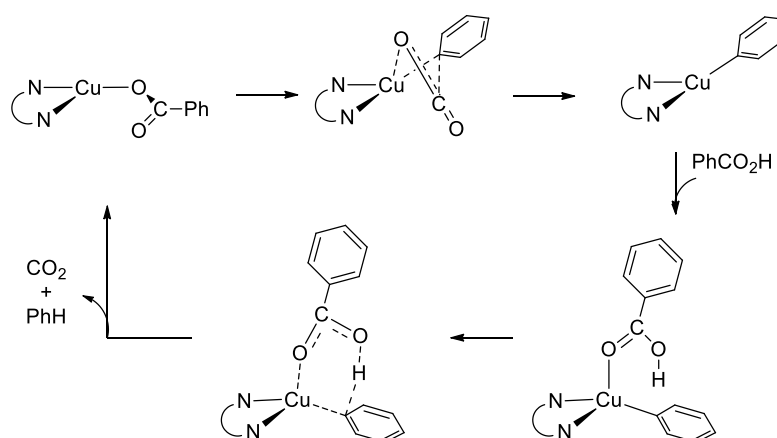

Scheme 4.7. Catalytic cycle proposed by Xue *et al.*

4.1.4 Summary of major points

Regarding the decarboxylation of cyclopropanecarboxylic acids, it is noteworthy that there is currently no metal-catalysed decarboxylative method reported and that the current methods require conditions that are incompatible with cross-coupling methodology.

The ‘*ortho*-effect’, by which the reaction is facilitated by substituents in the *ortho* position, is well-documented. For thermal decarboxylations, the presence of a

nitrogen atom in the 2-position has also been reported to drive the reaction through the formation of a zwitterion.

Basic solvents such as quinoline are effective and quinoline has also been shown to act as a proton source. The presence of coordinating agents, such as 1,10-phenanthroline and 2,2'-bipyridyl are shown to increase the efficacy of the copper catalyst.

Both EWGs and EDGs can accelerate the copper catalysed decarboxylation reaction. The charge generated during the reaction is thought not to distribute into the π -system, with substituents that can stabilise the negative charge along the σ -backbone driving the reaction forward. This effect is also seen with substituents that can stabilise the transition state and/or can destabilise the starting material.

As copper appears to be the most general metal for the catalysis of aromatic carboxylic acid decarboxylations, it was deemed appropriate to begin the investigation using copper as the catalyst. For copper catalysed decarboxylations of benzoic acids, the copper species that drives the reaction is Cu(I). There is evidence that an Ar-Cu σ -bond is formed.

4.2 Results and Discussion

4.2.1 Synthesis of starting materials

In order to maximise the effect of the aromatic substituents on the site of decarboxylation, 1,1-disubstituted rather than 1,2-disubstituted heteroaryl- and arylcyclopropanecarboxylic acids were used. For this reason the WEC reaction could not be used to synthesise the starting materials. Alkylation of the appropriate acetate or acetonitrile **93** afforded cyclopropanecarboxylates or cyclopropanecarbonitriles **94** *via* a Perkin synthesis.¹⁵ These were then hydrolysed to the cyclopropanecarboxylic acids **95** (Scheme 4.8).

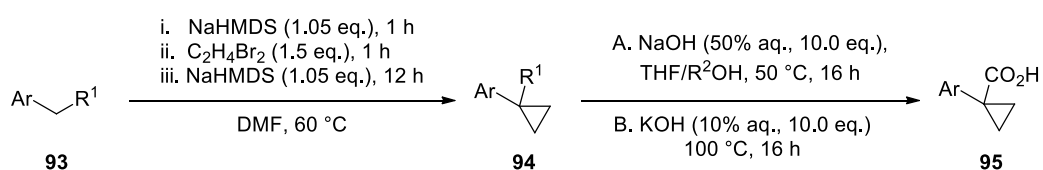

Ar = aryl, heteroaryl; R¹ = CO₂Me, CO₂Et, CN; R² = Me, Et

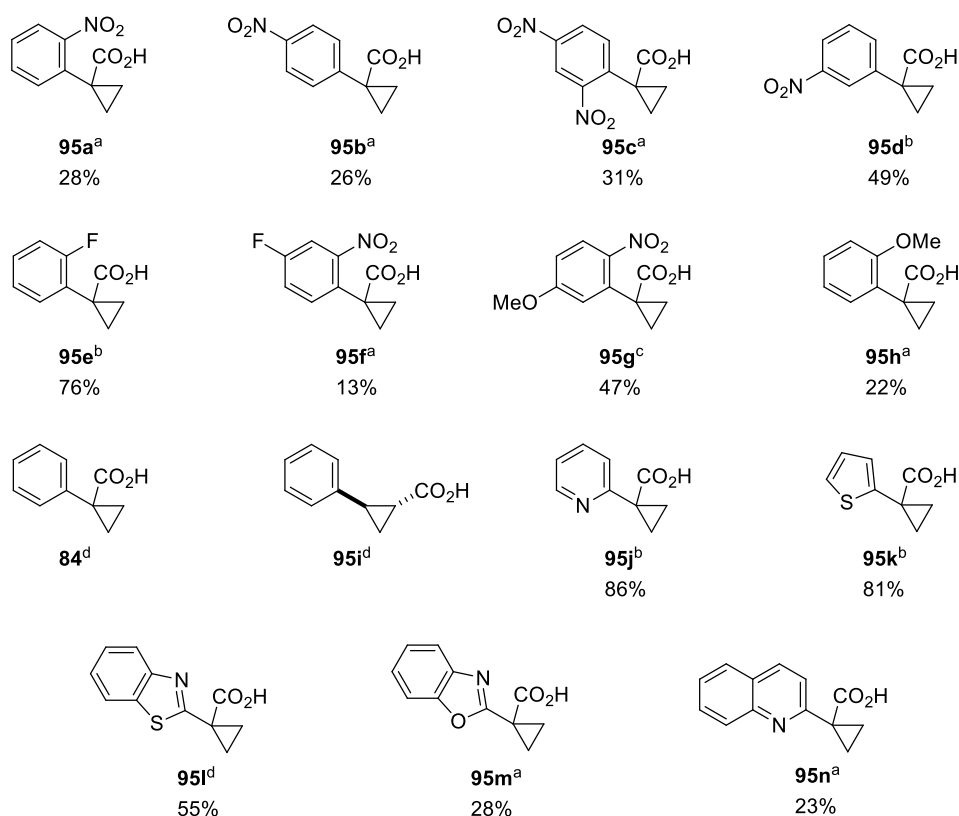

^a From methyl ester: method A; ^b From nitrile: method B; ^c From methyl 1-(3-fluoro-6-nitrophenyl)cyclopropanecarboxylate; ^d Commercially available; ^e From ethyl ester: method A; ^f Yields are over two steps

Scheme 4.8. Conditions for synthesis of cyclopropane substrates **95^f**

The starting materials for the nitriles were commercially available. Methyl 2-(4-fluoro-6-nitrophenyl)acetate (**93f**) and methyl 2-(3-fluoro-6-nitrophenyl) acetate (**93g**) were synthesised by the literature procedures from 2,5-difluoronitrobenzene and 1-(3-fluorophenyl)acetic acid respectively.¹¹⁴ Ethyl 2-(benzothiazol-2-yl) acetate (**93l**) and methyl 2-(benzoxazol-2-yl) acetate (**93m**) were synthesised by the literature procedure from 2-aminophenol¹¹⁵ and 2-aminothiophenol¹¹⁶ respectively. All the remaining esters were synthesised *via* a Fischer esterification from the corresponding carboxylic acid.

In general, cyclopropanation of the arylacetonitriles gave better yields than the arylacetates. This was attributed to a lower pK_a at the benzylic site. The nitriles were also more easily separated by column chromatography. The yields were usually in the range of 30–40% for this step, with some in the range of 60–90%. The best yield was found for methyl 1-(2-fluorophenyl)cyclopropane-1-carboxylate (**94e**) with a yield of 87%.

Initially a range of bases were used for deprotonation, depending on the relative pK_a at the benzylic position. For example, stronger bases such as lithium diisopropylamide (LDA) were used for methyl 2-(2-methoxyphenyl)acetate (**93h**) while weak bases, such as K₂CO₃ could be used for more electron deficient substrates such as methyl 2-(2,4-dinitrophenyl)acetate (**93c**).

However, NaHMDS was found to be effective for all screened substrates and was thus used in the general procedure. Strong but nucleophilic bases such as *n*BuLi could not be used as these could react with the ester or nitrile. In fact, use of KO^{*t*}Bu with methyl 2-(2-methoxyphenyl)acetate (**93h**) resulted in partial transesterification rather than the desired cyclopropanation, although it was effective for other substrates such as methyl 2-(quinol-2-yl)acetate (**93n**). Presumably the more acidic CH₂ centre of **93n** allowed easier attack at this position than at the ester. NaH could also be used as it was sufficiently non-nucleophilic even at higher temperatures.

The reaction was performed in one pot. The reagents could be added all at once but this gave a higher occurrence of side products so the stepwise addition procedure was then adopted. The amount of 1,2-dibromoethane was also reduced

from 2.0 to 1.5 equivalents in an attempt to reduce the likelihood of a dialkylation to form **93** rather than a cyclopropane (Scheme 4.9).

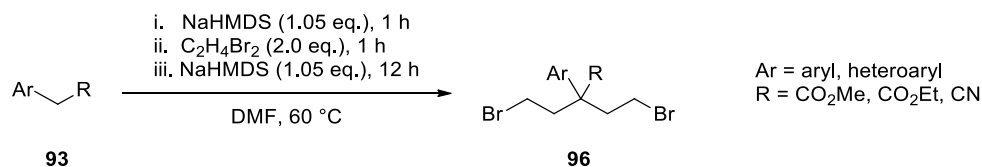

Scheme 4.9. Potential side-product from excess 1,2-dibromoethane

Hydrolysis of the resulting cyclopropane esters and nitriles gave the heteroaryl and arylcyclopropanecarboxylic acids.

4.2.2 Optimisation of the protodecarboxylation

The model compound used for proof-of-concept was 1-(2-nitrophenyl)cyclopropanecarboxylic acid (**95a**). This was chosen because electron-withdrawing substituents were shown to be more reliably reactive in the decarboxylation of benzoic acids (Section 4.1.3, p. 93). The NO₂ group lowers the pK_a at the benzylic site and should thus help to stabilise the intermediate during the decarboxylation, drawing electron-density out along the σ-backbone. Positioning the NO₂ group in the *ortho* position, could also assist the decarboxylation in terms of coordinating effects with the catalyst.

For screening, all reactions were run under argon on a 0.1 mmol scale at a concentration of 0.5 M in NMP (Table 4.1). In this discussion, all references to product yield (or conversion) are based on the amount of decarboxylated product in relation to the starting acid, as judged by ¹H NMR. Isolated yields were obtained at a later stage for successful reactions.

The reaction was first attempted thermally on both the acid and its sodium salt. The first evidence of decarboxylation of the acid was seen at 240 °C which, after 12 h, showed 15% decarboxylation by ¹H NMR analysis (entry 1, Table 4.1). The same conditions with the sodium salt gave 53% decarboxylation (entry 2).

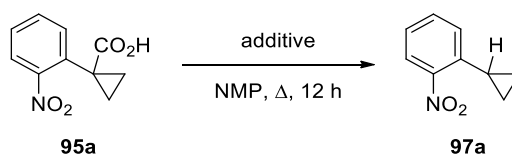
Table 4.1. Examining conditions for protodecarboxylation of **95a**

Entry	Temperature (°C)	Additive	Product (%) ^a
1	240	None	15
2	240	NaH (1.0 equiv)	53
3	150	10 mol % Cu ₂ O/phen ^b	100
4	140	10 mol % Cu ₂ O/phen ^b	30
5	120	10 mol % Cu ₂ O/phen ^b	15
6	135	Cu ₂ O/phen/3 Å mol. sieves	100
7	120	10 mol % Ag ₂ O	12
8	120	10 mol % Ag ₂ O/AcOH	40
9	140	10 mol % Ag ₂ O/AcOH	100

^a As observed by ¹H NMR analysis with respect to the starting material; ^b phen = 1,10-phenanthroline.

Following this, the catalyst system reported by Gooßen *et al.* for the protodecarboxylation of benzoic acids was tested on **95a**.¹¹⁰ **95a** was stirred overnight at varying temperature (entries 3–5) with Cu₂O (10 mol %) and 1,10-phenanthroline (10.5 mol %). Complete consumption of starting material was observed at 150 °C (entry 3), with only 30 and 15% conversion observed at 140 and 120 °C respectively (entries 4 and 5).

With the intention of applying the decarboxylation to a cross-coupling reaction at a later stage, the reaction was tested under anhydrous conditions in the presence of 3 Å mol. sieves to ascertain whether they would have a negative effect on the reaction. Unexpectedly, this resulted in complete consumption of starting material being observed at 135 °C (entry 6). This could be attributed to the slight basicity of the molecular sieves which have a pH of 10.5 (5% slurry in water). It may also be due to the large surface area provided by the sieves on which the reaction could take place. Molecular sieves alone did not exhibit any catalytic activity.

As softer metals such as Ag(I) and Au(I) were known to be more effective in decarboxylative reactions (Section 4.1.3, p. 93), these were also tested. Ag₂O

showed good catalytic activity (entries 7–9), with an improved conversion of 100% observed at 140 °C in the presence of AcOH (entry 9). However, as this catalyst (and Au(I)) did not show a significant reduction in the temperature required for decarboxylation and is much more costly, it was decided to continue to use Cu₂O.

The optimised conditions using Cu₂O (10 mol%) were therefore 135 °C in the presence of 3 Å mol. sieves with 1,10-phenanthroline as co-catalyst (10.5 mol%) to give an isolated yield of 83% (Scheme 4.10).

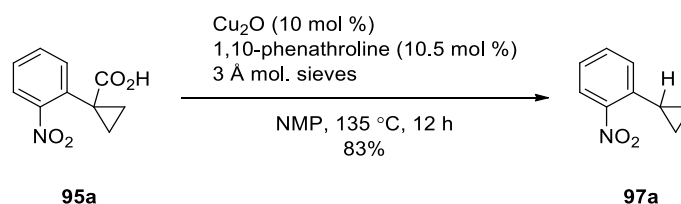

Scheme 4.10. Optimised protodecarboxylation of **95a**

4.2.3 Scope of the reaction

4.2.3.1 Screening of cyclopropanes

Once an optimised catalyst system had been found we were able to examine the scope of the reaction. To do this a range of cyclopropanes substituted with electron-rich and electron-poor aryl and heteroaryl groups were screened. The system used for screening involved an initial test of the thermal decarboxylation of the reaction by heating the compound neat in a test tube over a butane/propane gas flame (>300 °C) for approx. 10 seconds. This process gave some indication of how susceptible the acid was to decarboxylation based on the extent of conversion observed by ¹H NMR – *i.e.* if there was no evidence of decarboxylation under these conditions then it was likely that the copper-mediated system would require much higher temperatures if it was to undergo any degree of decarboxylation. It was found that compounds **95a**, **95b**, **95c**, **95e**, **95j**, **95l**, **95m** and **95n** were susceptible to flame decarboxylation. The lowest temperature at which these compounds decarboxylated was also identified by screening over 10 °C increments.

All screening of the catalytic system was carried out on a 0.1 mmol scale at 0.5 M concentration with 10 mol % of catalyst. Control reactions were also screened

without Cu₂O and catalysed reactions were tested with and without 3 Å mol. sieves. Each substrate was screened over a range of temperatures at 10 °C increments. The optimal temperature was the lowest at which complete consumption of starting material was observed by ¹H NMR after 12 h. Once this temperature had been determined the reaction was repeated at a 0.5 mmol scale and an isolated yield was obtained.

4.2.3.2 Non-heteroaromatic substrates

Table 4.2. Scope of the synthesis of heteroaryl and arylcyclopropanes

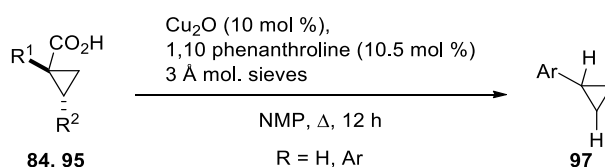

Entry	SM ^a	R ¹	R ²	Product	Temperature (non-catalysed ^b) (°C)	Yield (%)
1	95a		H	97a	135 (240)	83
2	95b		H	97b	135 (240)	85
3	95c		H	97c	120 (200)	87
4	95d		H	97d	190 (N/A)	50 ^c
5	95e		H	97e	150 (260)	61
6	95f		H	97f	175 (N/A)	50
7	95g		H	97g	175 (N/A)	72
8	95h		H	97h	200 (N/A)	39 ^d
9	84		H	97i	200 (N/A)	50 ^d
10	95i	H		97i	200 (N/A)	45 ^d

^a SM = Starting material, ^b First observation of any decarboxylation; ^cDetermined by ¹H NMR based on the ratio of starting material to product; ^dRequired 1.0 equiv. Cu₂O to decarboxylate within 12 h.

4.2.3.2.1 Electron-deficient substrates

1-(4-Nitrophenyl)cyclopropanecarboxylic acid (**95b**) was examined as its electronic properties are similar to those of the model compound 1-(2-nitrophenyl)cyclopropanecarboxylic acid. However it was possible that, without the potential for coordination with the catalyst, the temperature required could be higher. Overall, the 4-nitro substituted substrate showed the same behaviour as the 2-nitro substituted substrate (entries 1 and 2, Table 4.2). This indicates that the electron-withdrawing effect of the substituent rather than the coordinating ability of the substituent is the primary contributory factor in driving this reaction.

Given these results, the 2,4-dinitro substituted substrate **95c** (entry 3), was next examined to demonstrate whether there is an additive effect for substituents. Full consumption of starting material was observed from 130 °C in the absence of mol. sieves, with this being reduced to 120 °C upon addition of 3 Å mol. sieves, giving an isolated yield of 87%. These results demonstrate an additive effect for nitro substituents. The addition of mol. sieves did not affect the decarboxylation of any of the other substrates. This will be discussed further in Section 4.2.3.4 (p. 111).

Following this 1-(3-nitrophenyl)cyclopropanecarboxylic acid (**95d**; entry 4) was examined. In this case, the negative charge generated cannot be delocalised into the nitro group (Scheme 4.11) and, therefore, the nitro group will act as an inductive rather than a conjugative EWG.

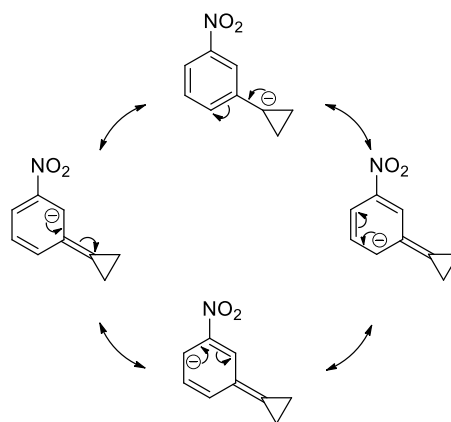

Scheme 4.11. Delocalisation of the negative charge into the aromatic system

It was found that this substrate required a temperature of 190 °C for significant decarboxylation. However, even at this temperature, the conversion by ¹H NMR was found to be only 50% and, therefore, the isolated yield was not obtained due to its poor performance.

Fluorine was now examined as an example of a stronger inductive EWG using 1-(2-fluorophenyl)cyclopropanecarboxylic acid (**95e**; entry 5) with fluorine in the 2-position where it would exert the strongest effect on the benzylic position. Due to its much smaller bulk, this would be unlikely to cause any steric hindrance. Screening of the catalysed reaction over a range of temperatures showed the starting material was consumed at 150 °C. The isolated yield of 61% was also significantly lower than that for the more active substrates already screened. Thus, it is more reactive than 3-nitro substituted **95d** but not as active as the other nitro-substituted compounds **95a–c**.

It can be concluded from these experiments that the conjugative electron-withdrawing and -donating ability of substituents on the aromatic ring significantly affects decarboxylation, with induction seeming to have little effect.

Additive effects were again examined for 2-nitro substituted substrates, with the addition of fluorine in the 4-position (**95f**; entry 6). The catalysed reaction showed total consumption of the starting material at 175 °C in 50% yield, a higher temperature and lower yield than **95e** and **95a–c**, showing that the fluorine atom in the 4-position counteracts the benefit of the nitro group.

This was unexpected and may be partly due to the resonance donation ability of fluorine increasing electron-richness at the benzylic position. Although this electron-donating effect is not usually significant for reactions such as aromatic substitution reactions, the greater susceptibility of the decarboxylation reaction to alterations in the π -system than to the σ -system could increase the contribution of fluorine's electron-donating effect to the decarboxylation. The bulk of the nitro group could also partially impede decarboxylation, which could explain the higher required temperature compared to the 2-fluoro substituted substrate **95e**.

4.2.3.2.2 More electron-rich substrates

The next compound that we intended to examine was 1-(3-fluoro-6-nitrophenyl)cyclopropanecarboxylic acid (Fig. 4.3). This was chosen to again investigate the additive effect of additional inductively electron-withdrawing substituents on **95a**, with the fluorine atom *para* to the nitro group.

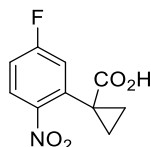

Fig. 4.3. Intended substrate 1-(3-fluoro-6-nitrophenyl)cyclopropanecarboxylic acid

Unfortunately, when hydrolysing the ester to the acid, the presence of methanol in the reaction caused the substrate undergo an S_NAr reaction to afford methoxy-substituted cyclopropane **95g** (entry 7). However, this allowed access to a substrate substituted with a conjugatively EDG *para* to the conjugatively EWG. The methoxy substituent could potentially deactivate the effect of the nitro group by donating electrons through the ring.

This substrate reacted under similar conditions to the previous 4-fluoro-6-nitrophenyl substrate **95f**, with full decarboxylation at 175 °C but a higher isolated yield of 72%. This was unexpected, as the electron-donating methoxy group was expected to increase the required temperature compared to **95f**.

Thus, the next step was to investigate the effect of the electron-donating methoxy substituent with 1-(2-methoxyphenyl)cyclopropanecarboxylic acid (**95h**; entry 8). Assuming that the pK_a of the benzylic site is the determining factor for the ease of decarboxylation, the higher pK_a , resulting from the EDG in the 2-position, would imply that **95h** would be difficult to decarboxylate.

A temperature of at least 200 °C was required under catalytic conditions. However, there was little conversion at this temperature, or at 250 °C. Increasing the amount of Cu_2O to 1.0 equiv. gave an isolated yield of 39%. Running the reactions over 24 h with 0.5 equiv. gave a comparable yield. These results corroborate the hypothesis that a lower pK_a at the site of decarboxylation will result in a more ready decarboxylation.

Taking this result into account in relation to 3-methoxy-6-nitrophenyl substrate **95g**, it seems that the electron-donating ability of the methoxy group does not have a large negative effect when it is in the 3-position to the site of decarboxylation as in **95g**, and thus is unable to significantly increase the pK_a by donating electrons into this site. However, as it is also *para* to the 2-nitro group, it may increase electron density on the nitro group, decreasing its electron-withdrawing strength, and **95g** is thus not as readily decarboxylated as the 2-nitro substituted substrate **95a**.

Given the lack of activity observed for the electron-rich substrate **95h**, the non-substituted arylcyclopropane **84** was also investigated (entry 9) as a neutral point from which to measure the relative facilitation of the decarboxylation by EWGs and EDGs.

Treatment under catalytic conditions resulted in similar results to those of the methoxy-substituted compound **95h**. The temperature required to initiate decarboxylation was 200 °C and with 1.0 equiv. of Cu_2O an isolated yield of 50% was obtained. This was to be expected with a relatively electron-rich unsubstituted phenyl substituent.

The above results demonstrate a clear correlation between the pK_a of the benzylic position and the ease of decarboxylation (Fig. 4.4).

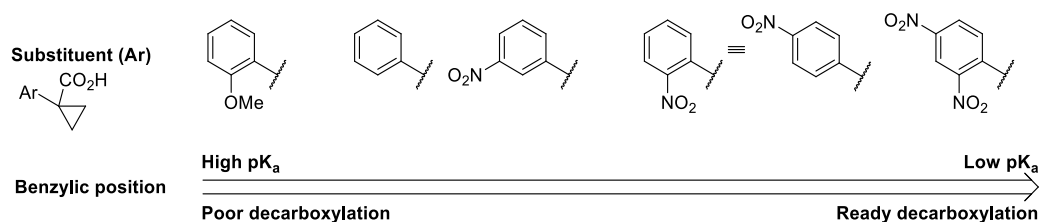

Fig. 4.4. Ease of decarboxylation of cyclopropanecarboxylic acids dependent on pK_a

Following this, the 2-phenyl substituted carboxylic acid **95i**, in which the carboxylic acid is not in the benzylic position, decreasing the contribution of the aromatic group on the pK_a at the site of decarboxylation, was examined (entry 10). This showed similar activity to the geminally substituted cyclopropanecarboxylic acid **84** and gave an isolated yield of 45% using 1.0

equiv. of Cu₂O, which is not significantly lower than that for **84** and is higher than that for 2-methoxyphenyl substrate **95h**, containing an EDG.

4.2.3.3 Heteroaromatic substrates

Table 4.3. Scope of the synthesis of heteroaryl and arylcyclopropanes

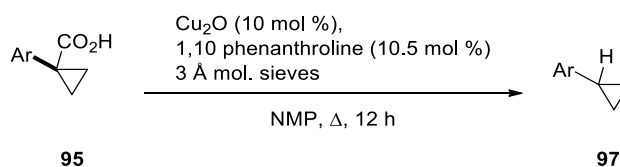

Entry	SM ^a	Ar	Product	Temperature (non-catalysed ^b) (°C)	Yield (%)
1	95j		97j	150 (240)	60
2	95k		97k	200 (N/A)	34 ^c
3	95l		97l	100 (110)	57
4	95m		97m	150 (190)	65
5	95n		97n	90 (95)	95

^a SM = Starting material, ^b First observation of any decarboxylation; ^c Determined by ¹H NMR based on the ratio of starting material to product.

Heteroaromatic substrates were also investigated. These can also provide an *ortho* effect for the decarboxylation of benzoic acids if they are substituted in the 2-position to a nitrogen atom (Section 4.1.2, p. 93).

The first heteroaromatic substrate examined was **95j**, containing a pyridine moiety (entry 1, Table 4.3). Catalytic screening showed that **95j** was fully consumed at 150 °C with an isolated yield of 60%, demonstrating a beneficial effect for the nitrogen atom in the *ortho* position.

The sulfur-containing thiophene-substituted cyclopropanecarboxylic acid **95k** was examined next (entry 2). Screening of the catalytic conditions showed that this substrate began to decarboxylate at 200 °C, which is comparable to the more electron-rich non-heteroaromatic substrates, albeit using just 10 mol % of Cu₂O in this case. This result indicates that sulfur does not participate in the reaction in the same way as nitrogen. This is possibly due to the position of the lone pairs, with those of sulfur being unable to overlap sufficiently with the carboxylic acid

group. Sulfur also does not form a zwitterion as readily as nitrogen in this oxidation state, which may also decrease the relative reactivity of this substrate.

Following this, **95l**, containing both a sulfur and a nitrogen atom in the *ortho* position to the cyclopropane ring, was screened (entry 3). The catalytic reaction was found to proceed rapidly at 100 °C in 57% yield, just 10 °C lower than that of the non-catalysed reaction. The incorporation of the nitrogen atom in a 5-membered ring may have led to an increased orbital overlap between its lone pair and the carboxylic acid group, increasing its ability to facilitate the reaction by coordination. Another contributory factor would be the bicyclic ring-system which will lower the pK_a at the site of decarboxylation.

To examine whether sulfur contributed in this case, the sulfur atom was replaced with an oxygen atom by incorporating a benzoxazole ring on the cyclopropane (**95m**; entry 4). **95m** began to decarboxylate thermally only from 190 °C. Screening under the catalytic conditions gave a temperature of 150 °C for complete conversion, the same as that for pyridyl substrate **95j**, but with a somewhat higher yield of 65%. This indicates that the sulfur atom plays a role in the dramatic reduction in temperature required for the decarboxylation of benzothiophenyl substrate **95l**.

The difference between these compounds could be explained by stabilisation of the starting material, or the initial copper complex, through hydrogen bonding. Oxygen will form stronger hydrogen bonds than sulfur and will therefore stabilise the starting material and require more energy to proceed to the next intermediate. The difference in dipole moment between benzothiazole and the transition states will also be lower, driving the reaction forward. Overall, these effects could make benzoxazolyl substrate **95m** more dependent on the catalyst and require a higher temperature for reaction.

The final substrate examined was the quinoline-substituted cyclopropanecarboxylic acid **95n** (entry 5). This would allow some conclusions to be drawn regarding the role of the bicyclic system. Thermal decarboxylation proceeded at the lowest temperature yet observed of 95 °C. Catalytic screening showed decarboxylation at just 5 °C lower, benefitting very little from the addition of the catalyst, similar to **95l**.

This clearly demonstrates a benefit to the fused ring system when compared to pyridyl substrate **95j**. Therefore it is probable that the decarboxylation of benzothiophenyl substrate **95l** benefitted from both the added aromatic ring and the addition of nitrogen to the ring, when compared to thiophenyl substrate **95k**. However, the conversion from the six-membered aromatic system to the five-membered system does not appear to be relevant, as the quinoline-containing substrate **95n** decarboxylated much more readily than the pyridine-containing substrate **95j**.

4.2.3.4 Influence of the substrate pK_a

The presence of 3 Å mol. sieves had no effect except in the cases of **95a–c**. If the mol. sieves are acting as a base then the difference in their effect could be explained by comparing the predicted effect of the substituents on the pK_as of each carboxylic acid. In the case of aromatics containing EDGs or unsubstituted aromatic groups (**84**, **95h** and **95i**), the pK_a of the acid would be higher and therefore could be resistant to facilitated deprotonation by the sieves, which are only weakly basic.

With EWGs the pK_a of the acid could be sufficiently low that the sieves are able to effect deprotonation. This effect could be greater in the case of conjugatively EWGs – *i.e.* 2- and 4-substituted compounds – as the negative charge can disperse through the system, which would explain the lack of effect on 3-nitrophenyl substrate **95d** and 2-fluorophenyl substrate **95e**. In the case of **95f** and **95g**, the effect of the 2-nitro substituent could be counteracted out by the electron-donating abilities of the fluorine atom and the methoxy group. For the sake of consistency, mol. sieves were included in all reactions as no negative effects were observed on their addition.

The trend in temperature can be explained in a similar manner to that of the mol. sieves, with carboxylic acids with a lower pK_a generally decarboxylating more readily at lower temperatures.

Overall, if calculable, the reduction in temperature between the catalysed and non-catalysed reactions ranged between 40–110 °C for total consumption of starting material (excluding **95l** and **95n**) and in 7 out of 15 cases, thermal

decarboxylation was not observed. This is therefore the first example of a metal catalysed decarboxylation of cyclopropanecarboxylic acids.

4.2.3.5 Functionalisable substrates

An attempt was also made to synthesise cyclopropanes **95o** and **95p** (Fig. 4.5) in order to demonstrate the decarboxylation on compounds that could be further functionalised.

However, several attempts at the reactions shown in Scheme 4.12 gave insufficient amounts of material to continue through to screening. These types of compounds could potentially be synthesised from other more expensive commercially available compounds.

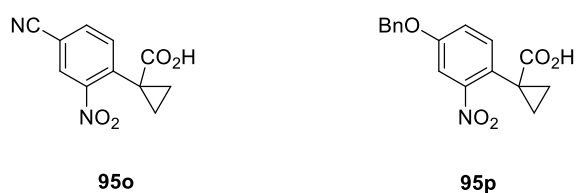
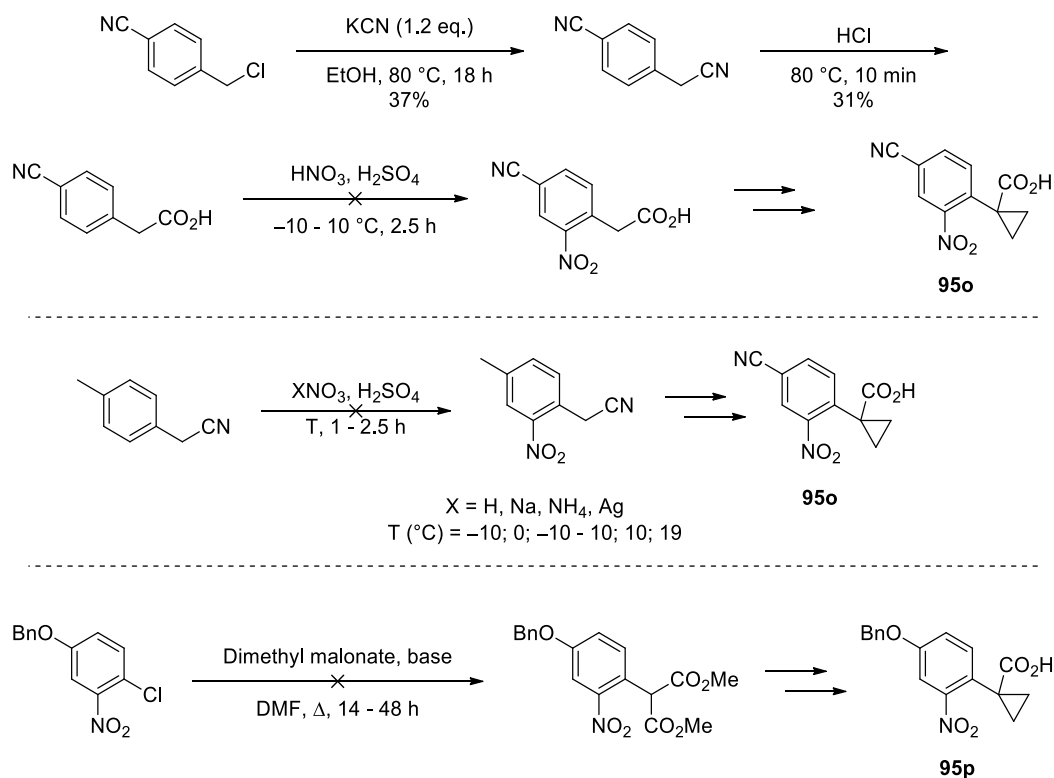

Fig. 4.5. Cyclopropanes **95o** and **95p** containing functionalisable groups



Scheme 4.12. Attempted syntheses of cyclopropanes **95o** and **95p**

4.2.3.6 Disubstituted cyclopropanes

With the scope of the reaction demonstrated in terms of mono-substituted cyclopropanes, it was decided to investigate the scope in relation to more complex disubstituted cyclopropanes. This was attempted first by the same method as previously using 1,2-dibromostyrene but this reaction did not proceed, presumably due to steric hindrance on the tertiary carbon. For these compounds, an alternative synthesis was therefore necessary.

Compound **95q** was synthesised *via* a $\text{Rh}_2(\text{OAc})_4$ catalysed reaction between **93a** and styrene to give **94q** *via* a modified literature procedure.¹¹⁷ This was then hydrolysed to give the diaryl cyclopropanecarboxylic acid **95q** (Scheme 4.13).

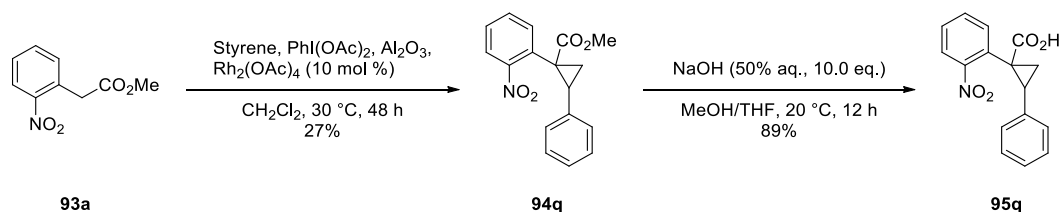

Scheme 4.13. Synthesis of **95q**

This cyclopropane was tested in the same way as before. There was no evidence of decarboxylation under thermal conditions. Under catalytic conditions no decarboxylation was observed below $175\text{ }^\circ\text{C}$ for 48 h. It was thought that with the extra steric bulk, the cocatalyst 1,10-phenanthroline, could be hindering the reaction. However, rerunning the reaction in the absence of 1,10-phenanthroline gave only a very slight improvement in yield. The diaryl substitution therefore seems to inhibit the reaction, possibly through steric effects.

4.2.4 Mechanistic studies

A brief mechanistic study into the reaction was carried out with **95a** to ascertain whether the reaction proceeded *via* a radical route. A radical inhibitor, 2,2,6,6-tetramethyl-1-piperidinyloxy (TEMPO), was added and the reaction was carried out under the standard conditions (Scheme 4.14).

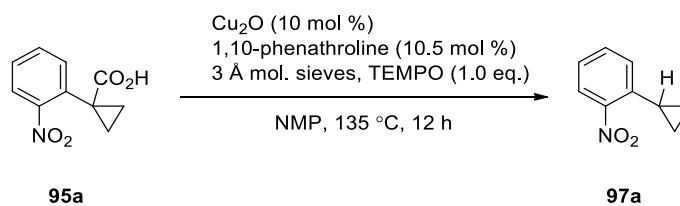

Scheme 4.14. Investigation of the mechanism of the reaction

No difference was observed between this reaction and the control reaction without TEMPO, which was run alongside. This indicates that the reaction does not proceed *via* a radical route, as could perhaps be predicted from the results obtained – *i.e.* the non-thermal reactions of benzothiazolyl substrate **95i** and quinolyl substrate **95n**, which suggest an ionic reaction mechanism. This is in accordance with the decarboxylation of benzoic acids (Section 4.1.3, p. 93).

4.3 Conclusions and future work

The first metal catalysed method for the decarboxylation of cyclopropane rings has been demonstrated. The reaction appears to be highly dependent on the pK_a of the benzylic site. The presence of a coordinating atom at the 2-position of the aromatic substituent also facilitates the reaction to proceed at a much lower temperature, with the catalyst enabling little reduction of the required temperature for **95i** and **95n**.

The effects of EDGs and EWGs on the aromatic ring show similar trends to those seen in the copper-catalysed decarboxylation of benzoic acids. In the case of cyclopropanes, this can be broadly related to the pK_a as EDGs will increase the pK_a at the benzylic position, increasing the required temperature. However, more electron-rich compounds showed no decarboxylation under thermal conditions and are fully dependent on the catalyst.

Notably, 2-phenyl substituted substrate **95i** also decarboxylated, with a yield close to that of **84**. This indicates that the decarboxylation of 1,2-substituted cyclopropanes will also be achievable under comparable conditions, which would improve the scope of the reaction further. The decarboxylations of these proceed under much milder conditions than the thermal conditions for **83** and **84** (Fig. 4.6),^{97d} demonstrating the ability of the catalyst to lower the energy of activation.

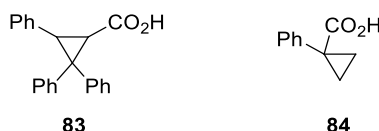
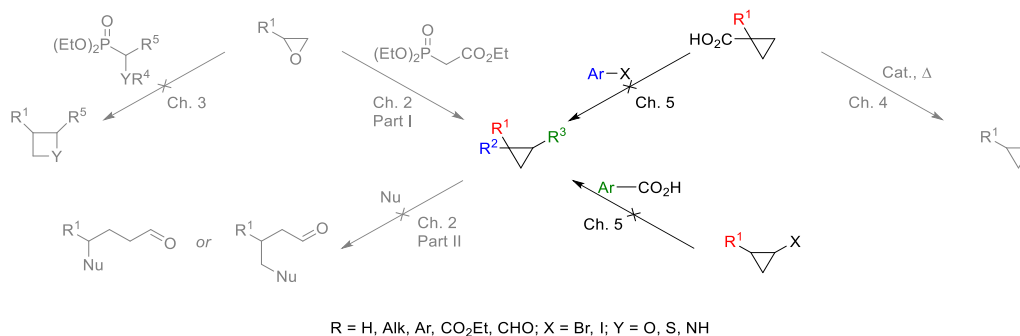

Fig. 4.6. Cyclopropanecarboxylic acids **83** and **84**

The decarboxylation of disubstituted cyclopropanes with less steric hindrance could also be attempted. Although requiring a higher temperature, these were still susceptible to decarboxylation and would provide a more complex structure, more akin to those found in biologically active compounds.

This method demonstrates the potential to employ this novel method for use in cross-coupling reactions. The cyclopropanes were shown to be stable to the high temperatures required in some cases for decarboxylation.

**Chapter 5 *Cross-Couplings of
Cyclopropanes via a
Decarboxylative Process***



This chapter describes initial attempts at cross-coupling of cyclopropyl halides with benzoic acids. The use of cyclopropyl halides rather than geminal cyclopropanecarboxylic acids would provide a less hindered site for cross-coupling for initial development, with the possibility of later developing a coupling of cyclopropanecarboxylic acids. This project took place over approximately six months at the end of the PhD.

5.1 Background

5.1.1 Decarboxylative cross-coupling reactions

The first efficient catalyst-mediated decarboxylative cross-coupling of carboxylic acids was performed in 2002 by the Myers group.¹¹⁸ This reaction was a decarboxylative Heck reaction and the same group have since isolated the Pd(II) intermediate containing the decarboxylated aromatic (LPdAr) and two molecules of DMSO, which was characterised by NMR and X-ray analysis. They found that the decarboxylation step was rate determining for this reaction.¹¹⁹

In 2006, two groups published work on the decarboxylation of aryl carboxylic acids. The work of Gooßen *et al.*, in which they demonstrate the copper catalysed protodecarboxylation of carboxylic acids, has been discussed in Section 4.1.3 (p. 93).¹¹⁰ In the same year, Forgione *et al.* published their serendipitous discovery of the palladium catalysed decarboxylative cross-coupling of heteroaryl carboxylic acids with aryl bromides.¹²⁰ This reaction proceeded in preference to that of the potentially competitive C–H functionalised product (Scheme 5.1).

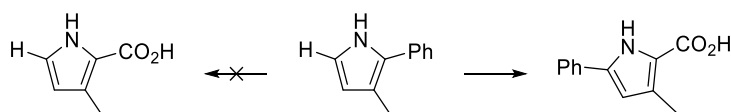

Scheme 5.1. Reaction observed by Forgione *et al* on treatment with PhBr, Bu₄NBr, Pd[P(*t*Bu)₃]₂ in DMF at 170 °C for 8 min in the microwave

The competing route was, in fact, one which afforded a diarylated product *via* a proposed intermediate by which the Pd(II) intermediate generated from oxidative addition of the aryl bromide inserts into the C–R bond (Scheme 5.2). When R = H, the substrate can enter the competing route for direct reductive elimination to form the 3-substituted heteroaromatic carboxylic acid, which can then re-enter the catalytic cycle and subsequently react *via* the second route, with Pd migration from C3 to C2, followed by decarboxylation.

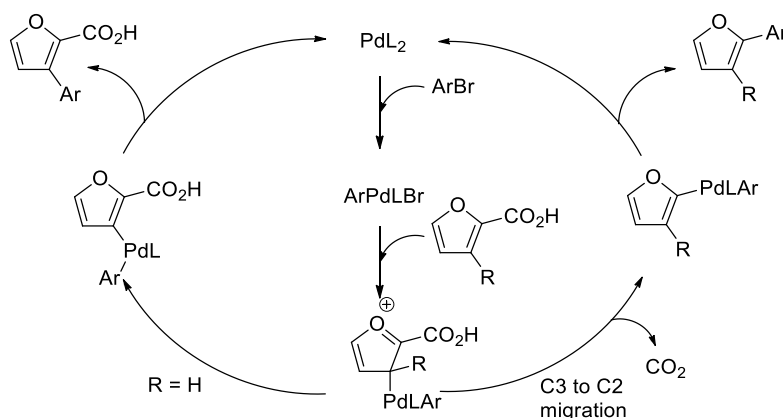

Scheme 5.2. Proposed catalytic cycle for palladium catalysed decarboxylative coupling

The lack of reactivity of 2-phenylfuran, the regioselectivity of the reaction and the low yields obtained for unsubstituted compounds were evidence for this catalytic cycle. The reaction did not proceed when using 3-furoic acid, which is in line with observations for protodecarboxylation – *i.e.* the presence of a heteroatom or other moiety in the 2-position facilitates decarboxylations (see Sections 4.1.2 and 4.1.3, p. 93).

Since these publications, there has been much interest in decarboxylative cross-coupling reactions for use in a variety of transformations including, among others, biaryl formation, aldol reactions, Heck-type reactions and Sonogashira-type reactions. Thus, despite the short period since the catalytic reaction was developed, there are already many reviews detailing gains made in the area.¹²¹

One publication of note, in relation to the current project, is that of Shang *et al.* in which they report the coupling of potassium polyfluorobenzoates with aryl iodides and bromides, mediated by copper only.¹²² Coupling with aryl bromides required the use of the cocatalyst 1,10-phenanthroline. They found that diglyme

was a much better solvent than *N*-methylpyrrolidinone (NMP) (which had been previously used by Gooßen *et al.*¹¹⁰), which they attribute to its increased coordination with K⁺. A solvent change to dimethylacetamide (DMA) was also required for fluoroaromatics containing less than five fluorines, demonstrating the high susceptibility of the reaction to the nature of the solvent. There was no reaction for the 2-fluoro- or 2-chloro-6-fluoro-substituted potassium benzoates, which demonstrates that the copper-catalysed system alone requires more activation than bimetallic systems.¹²³ In contrast to the work of Forgione *et al.*,¹²⁰ there was also evidence of diarylated coupling products by both decarboxylative coupling and C–H functionalisation of the same substrate. This could be a result of both the less reactive catalyst and the more acidic C–H bond.

Shang *et al.* also performed DFT calculations to predict whether the reaction proceeds first *via* oxidative addition of the aryl halide, followed by decarboxylation or *vice versa*.¹²² The calculations indicated that, although proceeding *via* oxidative addition first would give a lower energy barrier for the first step (+18.9 kcal mol⁻¹ vs +20.3 kcal mol⁻¹), the subsequent decarboxylation step has an energy barrier of 51.1 kcal mol⁻¹. Proceeding *via* decarboxylation first will give the initial energy barrier of 20.3 kcal mol⁻¹ for decarboxylation. This is followed by an oxidative addition barrier of 30.0 kcal mol⁻¹, giving a lower total energy requirement. Therefore, the reaction is likely to proceed *via* decarboxylation, followed by oxidative addition, which is in contrast to the route predicted by Forgione *et al.*¹²⁰ for their palladium catalysed system (Scheme 5.2, p. 118). The oxidative addition step also appears to be rate determining, in contrast to the findings of the Myers group for their Heck-type reaction.¹¹⁹

Another notable publication by Hu *et al.* provides some insight into the bimetallic silver/palladium catalysed decarboxylative coupling.¹²⁴ In this publication, the authors couple two benzoic acids that can be either similar or different to one another in terms of their electronic properties. To do this, they had to overcome issues which could lead to competing homocoupling and protodecarboxylation. Homocoupling and protodecarboxylation usually occur when the transmetallation and reductive elimination steps are too slow. This can be affected by the nature of the ligands on palladium,¹²⁵ which affects both the sterics and the electron density around the metal centre.

The two decarboxylation steps must also be balanced so that the two substrates would decarboxylate at the same rate, even with different electronic properties. It was found that electron-deficient benzoic acids generally lead to both the homocoupled and protodecarboxylated side-products, while electron-rich substrates lead primarily to the protodecarboxylated side-product. The rate of decarboxylation is highly dependent on the solvent, as demonstrated by Shang *et al.*¹²² and others.¹²⁶

Hu *et al.* found that highly polar solvents gave low yields, with the optimum system screened being DMSO/ethylene glycol dimethyl ether (DME) (3:17).¹²⁴ The best ligand of those screened was PCy₃, with less bulky, aliphatic ligands performing best and reducing side-reactions. The optimised conditions were successfully applied to the coupling of both electronically similar and electronically different benzoic acids with a variety of substituents.

For the bimetallic copper or silver and palladium systems, the decarboxylation is believed to be promoted by copper or silver, followed by transmetalation of the decarboxylated product onto palladium. This is followed by reductive elimination to give the cross-coupled product (Scheme 5.3).^{109b}

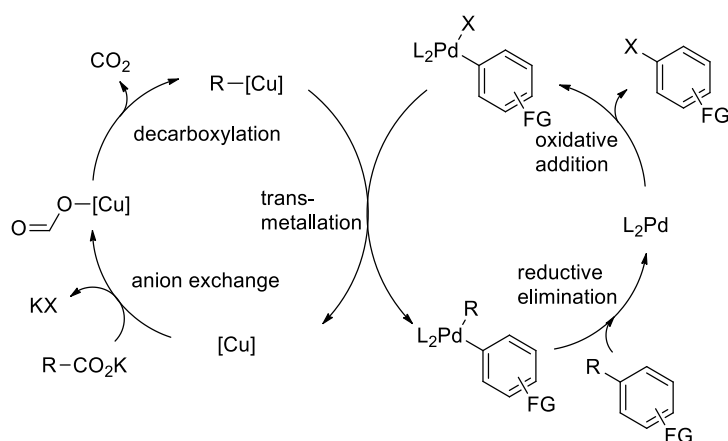

Scheme 5.3. Proposed catalytic cycle for bimetallic decarboxylative cross-coupling

The mechanism of the decarboxylation step has already been discussed in Section 4.1.3 (p. 93). The subsequent steps proceed *via* the well-established palladium coupling mechanisms.¹²⁷

5.1.2 Cross-coupling of cyclopropanes

Given their sp^2 -like-character (see Section 1.2.1, p. 14), cyclopropanes can undergo cross-coupling reactions in much the same way as aromatics.¹²⁸ There is a large number of examples of cyclopropanes taking part in cross-coupling reactions as the nucleophilic partner (*i.e.* Ar–M). However, there are much fewer examples of their application as the electrophilic partner (*i.e.* Ar–X), as discussed below.

The advantage that cyclopropanes have over other alkyl groups in cross-coupling reactions is that they are resistant to competitive β -hydride elimination due to the strained cyclopropene product that would be formed, making this process thermodynamically unfavourable. The increased s -character of the C–M bond also accelerates the transmetalation and reductive elimination steps, decreasing the time available for β -hydride elimination to occur.

5.1.2.1 Cyclopropanes as nucleophilic partners

Unsurprisingly, given its popularity in the wider field, the Suzuki reaction is by far the most commonly seen cross-coupling reaction of cyclopropanes. It proceeds under mild reaction conditions and has good functional group tolerance as well as relatively low toxicity. The reaction has been shown to proceed with retention of configuration and high optical purity.¹²⁹ It is also susceptible to changes in solvent (polar or non-polar),^{129b,130} base (*e.g.* Ag_2O , K_3PO_4)^{129b,c,e,130,131} and the nature of the boron group (*e.g.* boronate ester, boronic acid, trifluoroborate and bulky groups)^{129c,132}. There is one example of a Suzuki cross-coupling of a cyclopropane onto a quaternary centre (Scheme 5.4).¹³³ In this paper, de Meijere *et al.* describe the coupling of a bicyclopropyl unit with aryl iodides and aryl halides in low to moderate yields.

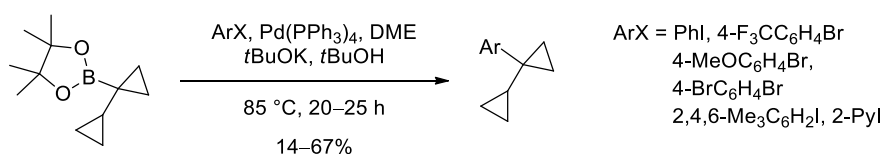

Scheme 5.4. Proposed catalytic cycle for bimetallic decarboxylative cross-coupling

Another commonly seen coupling reaction for cyclopropanes is the Kumada–Corriu reaction, which utilises Grignard reagents.¹³⁴ The drawback to this method

is that Grignard reagents are highly reactive, which necessitates the use of substrates containing non-sensitive functional groups. The Negishi¹³⁵ and Stille¹³⁶ reactions are also used quite frequently. The Stille reaction is not ideal for this process and generally provides low yields. This is probably due to slow transmetallation due to the weak nucleophilicity of the cyclopropyl tin species. Additives can be used to increase the yield and selectivity of the reaction.^{136a}

Other cross-coupling reactions that have been used for cyclopropanes are a copper-free Hiyama–Denmark reaction, using trifluorosilanes and coupling with aryl bromides,¹³⁷ and the use of tricyclopropylbismuth¹³⁸ and tricyclopropylindium¹³⁹ for coupling with halides and triflates.

This is a brief introduction to the literature precedent for cross-coupling with cyclopropanes as the nucleophilic partner. However, due to the large steric demand of the cyclopropane ring, the transmetallation step can be problematic. This leads to difficulties in the cross-coupling of multi-substituted cyclopropyl metals with very few examples of these known, the Suzuki reaction shown above (Scheme 5.4, p. 121) being a rare example. As our decarboxylation method had been focussed on decarboxylation at a quaternary centre, it was decided to pursue the decarboxylative cross-coupling with cyclopropyl halides and benzoic acids after initial unsuccessful attempts at cross-coupling of cyclopropanecarboxylic acids. Given the wealth of knowledge available on the decarboxylation of benzoic acids, it seemed advisable to first develop the reaction in this way, with the potential to revert to the use of cyclopropanecarboxylic acids in due course.

5.1.2.2 Cyclopropanes as electrophilic partners

The first report of the coupling of cyclopropyl halides by direct insertion of Pd(0) into the cyclopropyl halide bond was by Charette and Giroux in 1996.¹⁴⁰ The success of this was attributed to the aforementioned sp^2 -character of the cyclopropane. Cyclopropane **98** was coupled by a Suzuki reaction to a vinyl boronate ester (Scheme 5.5), with the reaction being highly dependent on the nature of the base and on the solvent. Increasing the solubility of the base slightly improved the yield (Na^+ to K^+ and the addition of a phase transfer catalyst), with an additional increase when changing from PhMe–H₂O to dimethylformamide (DMF)–H₂O.

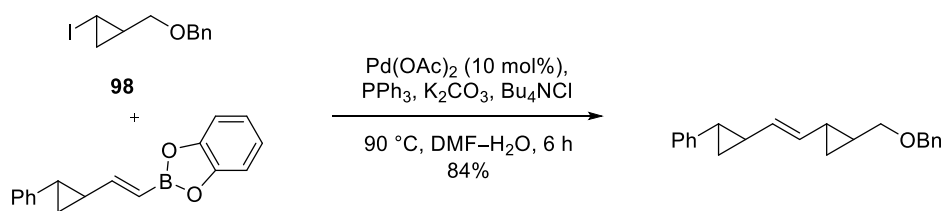

Scheme 5.5. Suzuki coupling with cyclopropyl iodides

Investigation of the scope of the reaction with respect to the boronate moiety showed that reactions with *ortho*-substituted aromatics gave lower yields. These were improved by the use of CsF as base, which allowed the *in situ* formation of BF₃, increasing the yield. Changing the solvent to DME and using CsF allowed the unreactive heterocyclic substrates to couple in 70% and 78% yield.

Following this, the reaction was extended for the formation of contiguous cyclopropanes, which can be found in natural products.¹⁴¹ This required the use of cyclopropanes as both the nucleophilic and the electrophilic partners. Attempting this reaction under the same conditions as used previously led to decomposition of the cyclopropyl iodide. Again, the base, solvent and the nature of the boronate ester had a dramatic effect on the reaction. Moving to a stronger base (KO*t*Bu), a less polar, anhydrous solvent (DME) and a more nucleophilic boronate ester, based on 1,3-propanediol and lowering the reaction temperature to 80 °C gave an optimum yield of 69% (Scheme 5.6).

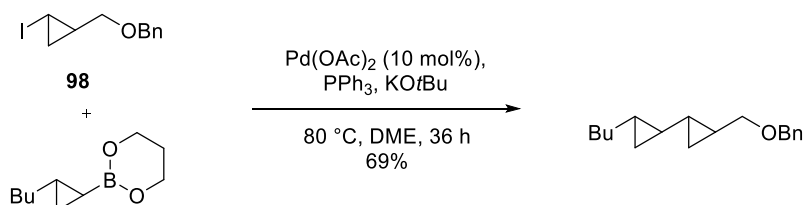

Scheme 5.6. Suzuki coupling to form contiguous cyclopropanes

The reaction in Scheme 5.6 was extended to form **99** and **100** (Fig. 5.1) in 60% and 71% yields respectively. The reaction time for these reactions was longer than those described in the previous paper.¹⁴⁰

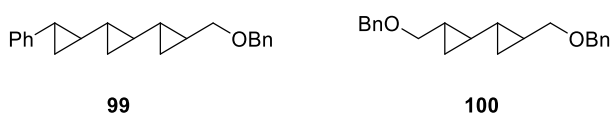
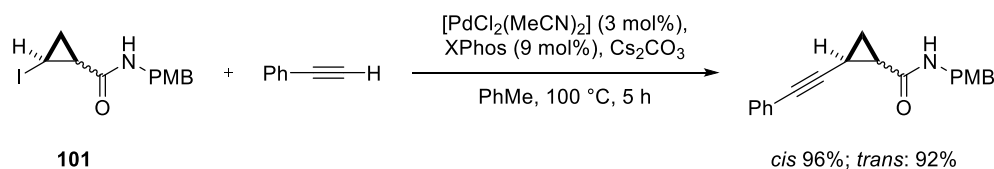

Fig. 5.1. Contiguous cyclopropanes **99** and **100** by Suzuki coupling

In addition to these procedures based on Charette's work, there has been one example of coupling of a cyclopropyl halide through direct Pd(0) insertion. This is an example of a copper-free Sonogashira-type coupling¹⁴² that has been used towards the synthesis of substituted 3-azabicyclo[3.1.0]hexan-2-ones, which are found in bioactive compounds (Scheme 5.7).¹⁴³



Scheme 5.7. Copper-free Sonogashira coupling of iodocyclopropane **101**

Initial attempts to couple **101** using standard Sonogashira conditions were unsuccessful, prompting the group to use this type of system, developed by Buchwald and Gelman, for the copper-free reaction.¹⁴⁴ The reaction was initially run in tetrahydrofuran (THF) at 60 °C, giving yields of 72–97% for a range of cyclopropanes and alkynes. However, for bulky cyclopropane **101**, the oxidative addition step was slow and led to a competitive oligomerisation reaction of the alkyne. The use of toluene and an increased temperature of 100 °C, as well as slow addition of the alkyne allowed the coupling of this cyclopropane with various alkynes in yields of 76–98%. The reaction proceeded with retention of configuration.

These few examples represent the extent of the literature examples of the direct insertion of palladium into a cyclopropyl halide bond, with conservation of the cyclopropane ring. This type of reaction is therefore limited as yet, but the generally high yields are promising for the further development of this type of process.

In summary, it can be seen that the cross-coupling of cyclopropyl halides by direct Pd(0) insertion and the decarboxylative coupling of benzoic acids are both highly susceptible to changes in solvent, pH, catalyst, ligand and steric bulk on the substrates.

For decarboxylative cross-coupling reactions it is highly important to balance the two catalytic cycles so that the decarboxylation and the oxidative addition step

will occur at similar rates, in order to prevent competing side-reactions. This requires tuning of the factors listed in the previous paragraph.

The coupling of cyclopropyl halides by direct insertion of Pd(0) has been reported in only three publications although cyclopropanes have been extensively cross-coupled as the nucleophilic partner.

5.2 Results and discussion

5.2.1 Attempts at cross-coupling of cyclopropanecarboxylic acids

Before transferring attention to the cross-coupling of cyclopropyl halides, the cross-coupling of both **95a** and **95b** was attempted under Gooßen's conditions¹¹⁰ at 125 °C, the temperature of their decarboxylation (Scheme 5.8).

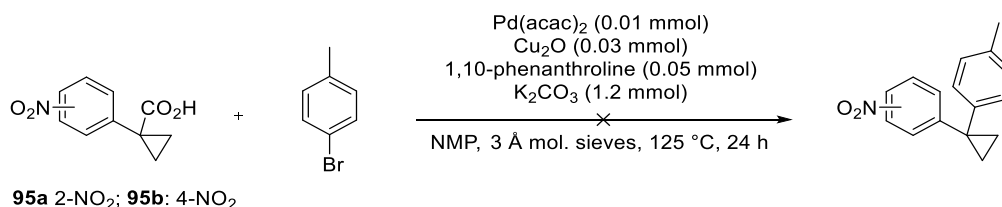

Scheme 5.8. Attempted decarboxylative cross-coupling of **95a** and **95b**

This reaction did not proceed in the presence or absence of K₂CO₃, or using Pd(OAc)₂ as catalyst. It was thought likely that the quaternary centre was too sterically congested for coupling as transmetalation onto the palladium centre would be hindered. This was backed up by the knowledge that there is only one report of a Suzuki cross-coupling at a quaternary cyclopropane centre, the yields of which were not high and could not be improved.¹³³ Therefore, attention was turned to coupling at a tertiary centre by the coupling of cyclopropyl halides with benzoic acids, using the documented Suzuki cross-coupling of cyclopropyl iodides and the well-developed cross-coupling of benzoic acids for reference.

5.2.2 Initial attempts at cross-coupling of bromocyclopropane

The first attempts at this involved the use of commercially available bromocyclopropane. This was screened against **102** and **103**, and their potassium salts **104** and **105**, respectively, under various conditions (Scheme 5.9). **102–105** were also screened at a range of temperatures to find their temperature of decarboxylation, which was 125 °C for the potassium salts and 100 °C for the acids, in the presence of either Cu₂O or CuI (10 mol %).

The reaction was screened at 100, 125, 130 and 150 °C in dioxane, diglyme and NMP. Reactions at 100 °C returned the starting cyclopropane only, with no evidence of decarboxylation, as would be expected when using the potassium salt.

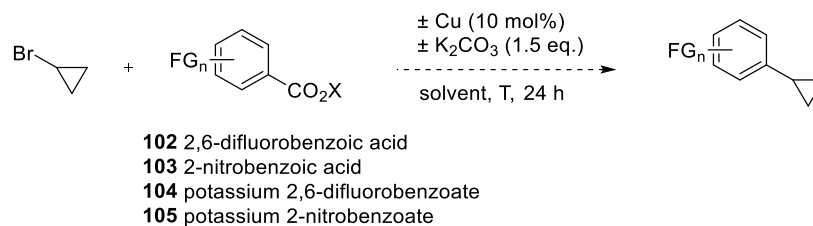

Scheme 5.9. Attempted cross-coupling of bromocyclopropane

Once the temperature was raised to 125 °C, there was evidence of side-products **106** and **107** (Fig. 5.2), which were identified at a later stage, as well as some remaining starting cyclopropane. The crude ¹H NMR showing these products is shown in Fig. 5.3. There was no indication at this point that the cross-coupling reaction was taking place.

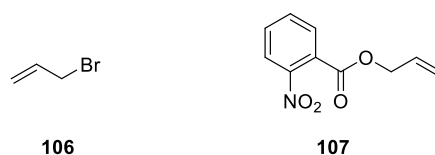

Fig. 5.2. Products from attempted cross-coupling of bromocyclopropane

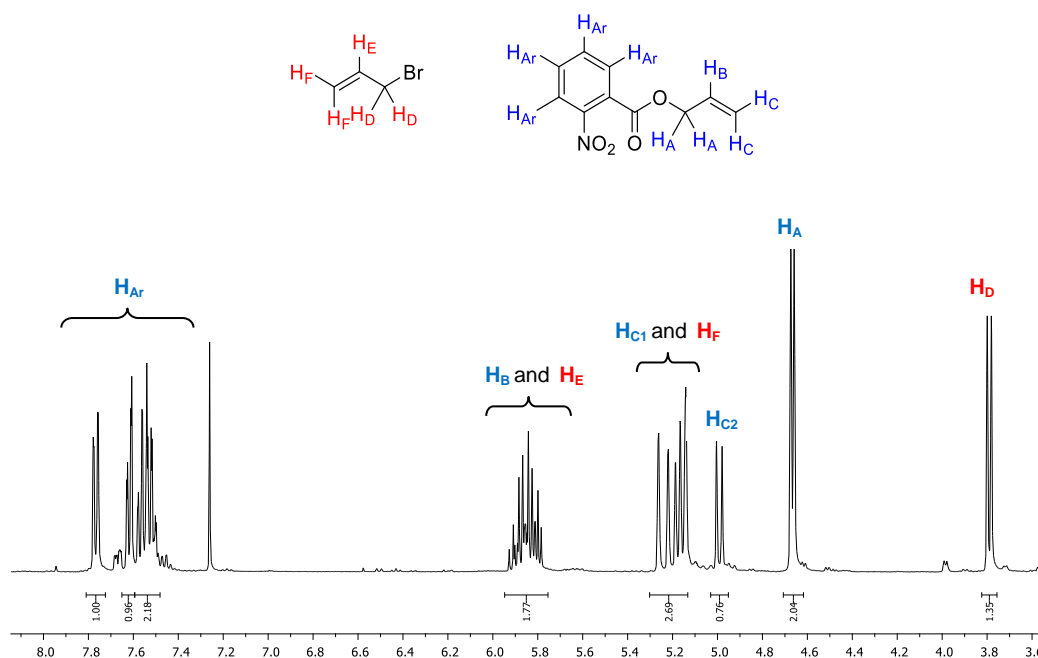

Fig. 5.3. Crude ¹H NMR showing allyl bromide **106** and ester **107**

Raising the temperature to 130 °C only resulted in complete consumption or evaporation of the cyclopropane, with formation of **106** and **107**. Raising the temperature further to 150 °C did little to alter the situation, except that there were now clear signs of the protodecarboxylated product. This implied that either the decarboxylation step was too slow, allowing complete consumption of the cyclopropane in side-reactions before cross-coupling could take place, or the transmetalation step was too slow. Control reactions of all substrates showed that the cyclopropane would also degrade to allyl bromide in the absence of catalyst at 110 °C. It's likely that both factors were hindering the reaction. More extensive screening of **105** with Pd(PPh₃)₃ and the silver salt of the benzoic acid at various temperatures and in various solvents, showed the same trend in byproduct formation. There was no evidence of coupling for any of these reactions.

The substrate cyclopropane clearly suffered from drawbacks, in that it was too ready to ring-open and that its boiling point is 69 °C, meaning that, although the reactions were performed in sealed vials and 5 equiv. of bromocyclopropane were used, a large amount of the cyclopropane would be in the gas phase.

5.2.3 Synthesis of (*trans*-2-iodocyclopropyl)benzene

Thus, a cyclopropane with a higher molecular weight was needed. It was also decided to use an iodocyclopropane, as these are the species that have been coupled in the literature. For these reasons, iodocyclopropane **108** was chosen.

To synthesise **108**, the first reaction attempted was a simple deprotonation of diiodomethane, which attacked styrene to give cyclopropane **108** (Scheme 5.10), according to the general cyclopropanation procedure discussed in Chapter 1 (Section 1.3.1.1., p. 21, Scheme 1.7(C)).²² This reaction proceeded with 42% yield, but gave a mixture of the *cis* and *trans* isomers. These were separable, with clean isolation of the *trans* isomer after flash column chromatography, but the yield was poor.

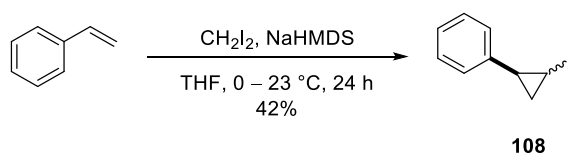

Scheme 5.10. Our first synthesis of iodocyclopropane **108**

An attempt was then made to synthesise **108** through a radical decarboxylation¹⁴⁵ with *N*-iodosuccinimide (NIS) (Scheme 5.11). Unfortunately this reaction did not proceed and starting materials were recovered.

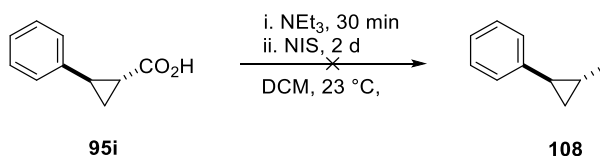

Scheme 5.11. Attempted synthesis of iodocyclopropane **108** using NIS

Following this, the Hunsdiecker reaction of **95i** was performed to give **108** in a yield of 12% over the two steps (Scheme 5.12).¹⁴⁶ The low yield was unfortunate but, as there was now some iodocyclopropane available, it was decided to attempt the cross-coupling and to optimise the synthesis at a later stage.

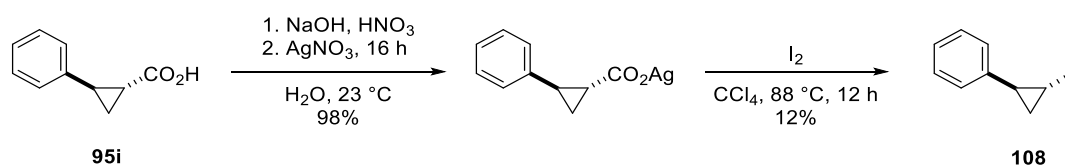

Scheme 5.12. Synthesis of iodocyclopropane **108**

5.2.4 Screening of (*trans*-2-iodocyclopropyl)benzene

With some **108** in hand, its cross-coupling with **105** was attempted (Scheme 5.13). Screening was initially carried out with Cu₂O, CuI and Pd(acac)₂ at 125 °C in diglyme.

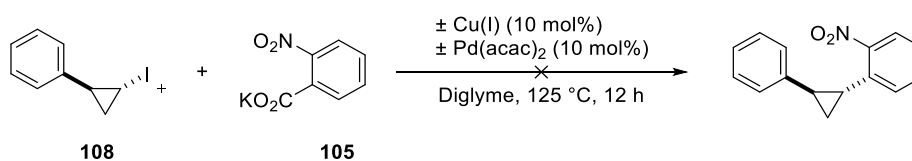

Scheme 5.13. Attempted coupling of iodocyclopropane **108**

Analysis of the crude reaction mixtures showed formation of the ring-opened product **109** and the ester **110** (Fig. 5.4). The ¹H NMRs are shown in Fig. 5.5 (a) and (b) respectively. Initially, the ester **110** was misidentified as **111** (Fig. 5.4), which encouraged us to attempt the reaction using a less reactive cyclopropane.

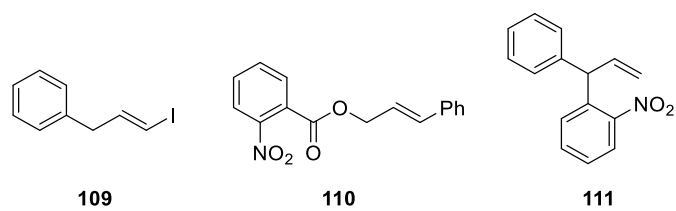

Fig. 5.4. Possible products of attempted cross-coupling of **108**

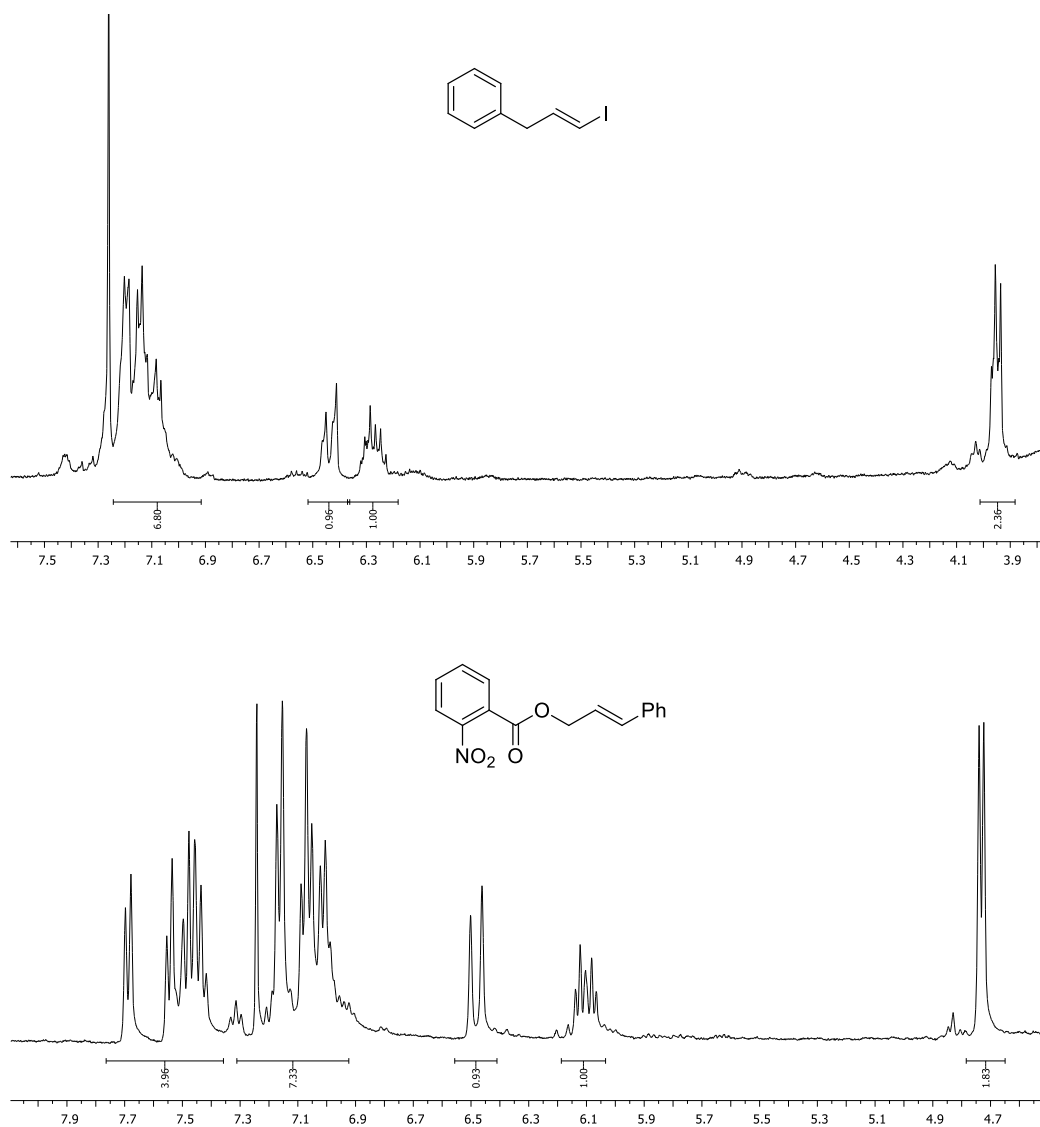

Fig. 5.5. ^1H NMRs of the crude reaction mixtures showing **109** (a) and **110** (b)

It was thought that a cyclopropane that was not substituted at the benzylic position would be less likely to be attacked nucleophilically at this site.

Therefore, it was decided to opt for cyclopropane **98** that has been coupled by Charette *et al.*^{140,141}

5.2.5 Synthesis of (*E*)-(2-iodocyclopropyl)methoxy)methyl)benzene

The first attempt at the synthesis of iodocyclopropane **98** was through the deprotonation procedure that had previously been used for **108** (Scheme 5.10, p. 128), first using NaHMDS, then LDA, *n*BuLi and KO*t*Bu (Scheme 5.14). However, this reaction did not proceed as desired using any of these bases.

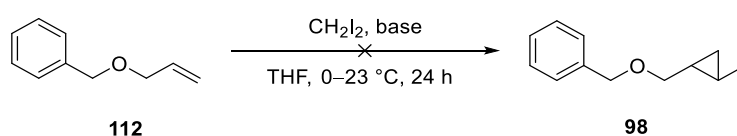

Scheme 5.14. First attempted synthesis of iodocyclopropane **98**

Subsequently, the same reaction was attempted with allyl bromide and allyl chloride but again gave none of the desired product (Scheme 5.15). **112** may have fragmented to benzyl alcohol and 3,3-diiodopropene upon attack by the diiodomethane anion, while allyl chloride and allyl bromide could have lost their respective halide anions.

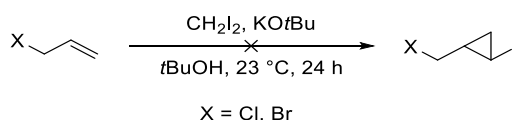

Scheme 5.15. Second attempted synthesis towards iodocyclopropane **98**

Following this, it was decided to synthesise iodoalkene **113**, which could be cyclopropanated by the Simmons–Smith method, as had been demonstrated by Charette *et al.*¹⁴⁰ **113** was accessible *via* known methods, involving iodination of propionic acid to form **114**,¹⁴⁷ followed by DIBALH reduction¹⁴² (Scheme 5.16). **113** was obtained in an optimum yield of 66% but the reaction was poorly reproducible, giving yields of 5–66%. The reduction was attempted using borane–THF as an alternative reducing agent, giving a yield of only 33%.

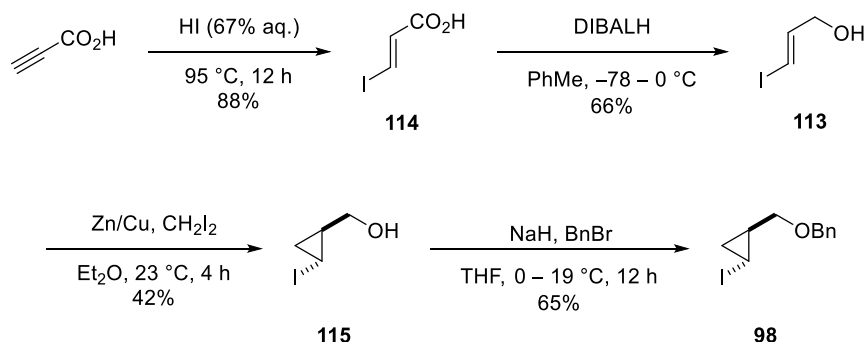

Scheme 5.16. Our first route to **97** through the Simmons–Smith reaction

The cyclopropanation was carried out using a Zn–Cu couple, prepared according to the procedure described by Shank and Schechter.¹⁴⁸ The Zn–Cu couple was sonicated with the iodoalkene **113** for 4 h, giving an optimum yield of 42% for **115**. However, this reaction was again poorly reproducible due to the difficulties in obtaining a consistent quality of Zn–Cu couple.

Benzylation of **115** was performed using NaH in THF.¹⁵² Previous attempts with K_2CO_3 , NEt_3 and Hünig's base gave no reaction, with starting materials recovered intact.

With issues in the formation of **113** and **115**, an alternative route was adopted, in which carboxylic acid **114** was converted to ester **116** in 87% yield (Scheme 5.17). This was then converted to alcohol **113** by $LiAlH_4$ reduction,¹⁴⁹ giving the alcohol in a yield of 55% from **114**. Given that this was not much reduced from the optimum yield of 66% through the previous route, this was a viable, reproducible route to **113**. The $LiAlH_4$ reduction was extremely time sensitive, with elongated reaction times giving degradation products. The reaction therefore had to be stopped before complete consumption of the starting material in order to obtain the optimum yield.

The cyclopropanation step was performed with **115** using the more convenient zinc source, Et_2Zn , to give a yield of 31%.¹⁴⁰ The reaction was performed in the dark in a cryostat to maintain the temperature at 0 °C.

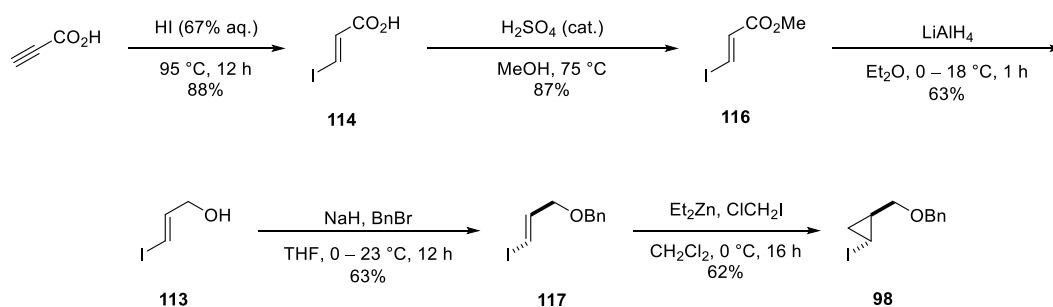

Scheme 5.17. Our final route to iodocyclopropane **98**

The reaction is more effective using the ether rather than the alcohol, as shown by Charette *et al.*¹⁴⁰ The final two steps were therefore switched so that the iodoalkene **113** was benzylated to give **117**, followed by cyclopropanation of the resulting ether¹⁴⁰ to give **98** in a reliable yield of 62%. The reaction could be run overnight in the cryostat to increase the yield. The carbon source was changed from diiodomethane to chloriodomethane, according to reports that this performed much more efficiently.¹⁵⁰ The increased yield when using this reagent could be due to the higher electronegativity of the chloride ion, which would increase the electrophilicity of the carbenoid centre, making it more susceptible to attack by the alkene.

With a moderate yielding route to **98**, it was now possible to synthesise this material in large enough quantities to perform an extensive screening.

5.2.6 Screening of (*E*)-(2-iodocyclopropyl)methoxy)methyl)benzene

Initially, as at this point it was assumed that the reaction of iodocyclopropane **108** with **105** had produced coupled product **111**, it was decided to use these conditions (CuI at 125 °C in diglyme) in the hopes that a less reactive cyclopropane may remain intact during the coupling (Scheme 5.18).

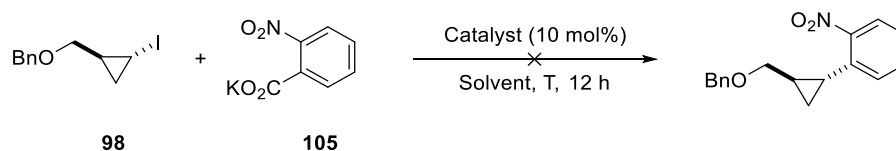

Scheme 5.18. Attempted cross-coupling of **98**

However, this reaction was unsuccessful, giving only the ester **118** (Fig. 5.6), the equivalent of which had been obtained under the same reaction conditions with **108**. The ester **118** was isolated and a HRMS was obtained, which showed the

product was in fact the ester and not the coupled product that had previously been assumed. The ^{13}C NMR data also correlated with this finding.

However, as there was no evidence of significant degradation of **98**, this reaction was more promising than those for **108**. The requirement now was to tune the reaction conditions to enable faster decarboxylation so that the ester could not be formed. Extensive screening was therefore carried out against **98** with a range of catalyst systems (Cu_2O , CuI , $\text{Cu}_2\text{O}/\text{Pd}(\text{acac})_2$, $\text{CuI}/\text{Pd}(\text{acac})_2$, $\text{Pd}(\text{acac})_2$, $\text{Cu}_2\text{O}/\text{Pd}(\text{OAc})_2$, $\text{CuI}/\text{Pd}(\text{OAc})_2$, $\text{Pd}(\text{OAc})_2$), a range of temperatures (90–160 °C in 10 °C increments) and in both NMP and diglyme.

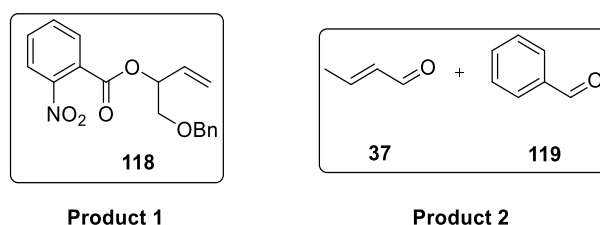

Fig. 5.6. Products from the attempted cross-coupling of **98**

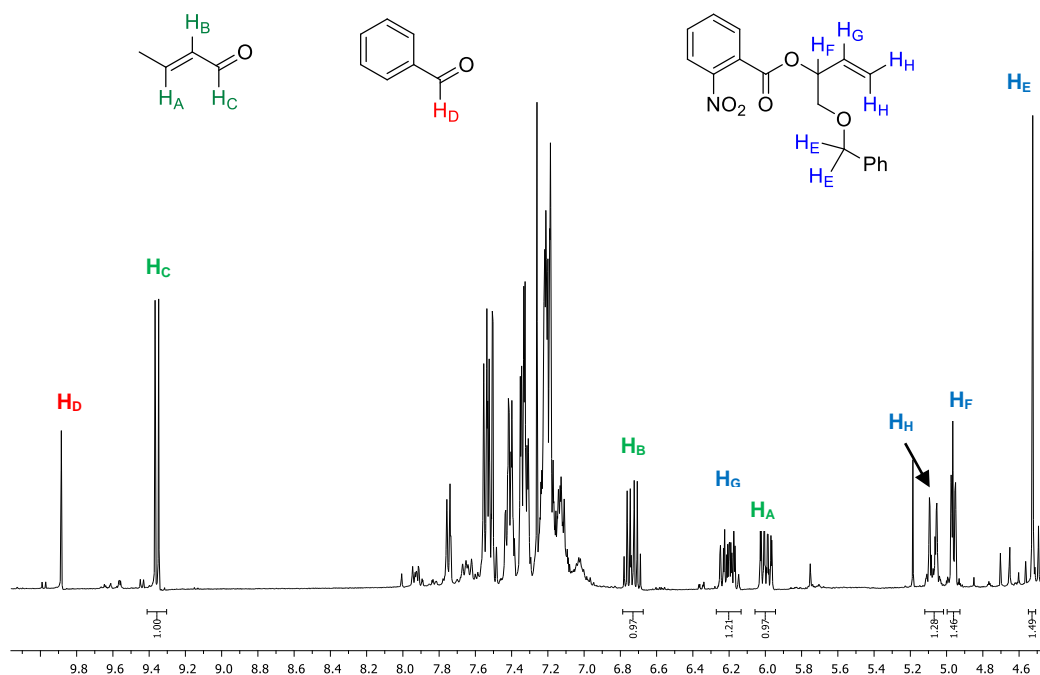

Fig. 5.7. Crude ^1H NMR of the reaction mixture showing **37**, **118** and **119**

The major products were **118** (Product 1), **37** and **119** (Product 2) as shown in Fig. 5.6, indicating again that the decarboxylative step was not proceeding fast enough, as the ester degradation product was being produced before decarboxylation could occur. The ^1H NMR of these products is shown in Fig. 5.7.

Control reactions showed that the cyclopropane began to degrade to **37** and **119** between 110 and 130 °C. This presumably was achieved by hydrolysis with residual water and further oxidation under the reaction conditions. A solvent screen of **98** showed that it also degrades in xylene, mesitylene, nitrobenzene, anisole, NMP, DME, DMF and DMSO.

Following this, an examination of the literature showed that **120** (Fig. 5.8) could be converted to its protodecarboxylated product using $\text{Ag}(\text{OAc})_2$ at temperatures as low as 80 °C in NMP, while 2-nitrobenzoic acid **103** could be coupled in an unoptimised procedure using $\text{Ag}_2\text{CO}_3/\text{PdCl}_2$ at 120 °C in NMP.¹¹¹ It was thus decided to use benzoic acid **121** in order to screen a methoxy-substituted acid, which are known to decarboxylate readily under silver catalysis, and to use silver salts for the cross-coupling.

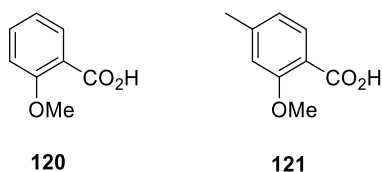

Fig. 5.8. Methoxy-substituted acids **120** and **121**

103 and **121** were screened against **98** with $\text{Ag}(\text{OAc})_2$ and Ag_2O , each in combination with $\text{Pd}(\text{OAc})_2$ and $\text{Pd}(\text{acac})_2$, under the same reaction conditions as were screened previously. These reactions resulted in both protodeiodination and the formation of the *cis* diastereomer at temperatures above 110 °C, as well as the previously seen side-products.

It is evident from the above results that the decarboxylation step is still proceeding at too slow a rate for coupling with this cyclopropane. The halocyclopropanes used thus far have been too reactive for coupling with benzoic acids under these conditions, with bromocyclopropane and **108** being susceptible to ring opening and **98** being susceptible to ring-opening and fragmentation. A

cyclopropane substituted with a longer alkyl chain may produce more successful results.

In order to confirm that decarboxylative and Suzuki cross-couplings could be achieved in our hands, published reactions of **98**¹⁵¹ and **103**¹⁵² were performed and proceeded as reported (Scheme 5.19).

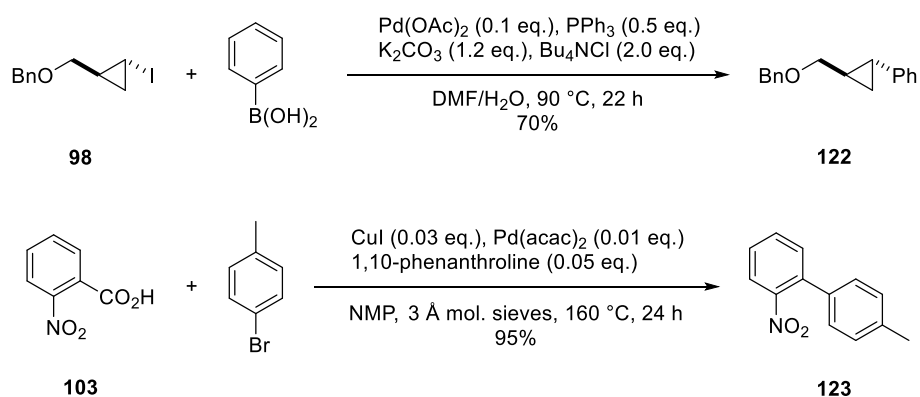

Scheme 5.19. Cross-coupling of **98** and **103** to form **122** and **123**

Notably, cyclopropane **98** did not degrade to any of the previously seen products. However, given the lower reaction temperature this would be expected. Thus it is clear that the decarboxylation step must be achieved at a lower temperature and at a sufficient rate in order to enable a decarboxylative cross-coupling reaction to take place with cyclopropanes. A more robust cyclopropane would also favour the reaction.

5.3 Conclusions and future work

These initial efforts to develop a decarboxylative reaction for the coupling of halocyclopropanes with benzoic acids have illuminated the key issues in developing such a reaction:

1. The two catalytic cycles must be balanced so that the oxidative addition step and the decarboxylation step occur at a similar rate, in order to prevent the degradation of the cyclopropane before transmetallation of the decarboxylated aromatic species is possible.
2. The presence of water in the reaction contributes to further competing processes, such as degradation of **98** to crotonaldehyde and benzaldehyde, protodeiodination and protodecarboxylation. Exclusion of water is more difficult to achieve on a 0.1 mmol scale, at which all screening was carried out and therefore, a larger scale during screening would be beneficial.
3. Tuning of both the benzoic acid and the cyclopropane species is required. The benzoic acid must be decarboxylated at a sufficient rate and preferably at a temperature below 100 °C, at which the cyclopropanes appear to begin to degrade. The cyclopropane could possibly withstand higher temperatures if it was substituted with a longer alkyl chain which was unable to fragment. However, these issues point to a limitation in the scope of the reaction.

An alternative solution would be to revert to the original intention to couple cyclopropanecarboxylic acids with haloarenes. Protodecarboxylations of cyclopropanes have been shown to proceed with no evidence of degradation at extremely high temperatures and in the presence of a metal catalyst (Chapter 4), while haloarenes are routinely used at elevated temperatures in cross-coupling reactions. The success in the decarboxylation of **95i**, albeit with a lower yield than **84**, indicates that 1,2-substituted cyclopropanecarboxylic acids substituted with stronger electron-withdrawing substituents, could be more readily decarboxylated in good yields and at more appropriate temperatures.

This brief investigation has thus provided information from which to build a successful method for the decarboxylative cross-coupling reactions of cyclopropanes.

Chapter 6 *Summary and Future
Work*

Chapters 2–5 of this thesis describe the forays made into the chemistry of small rings during this PhD.

Chapter 2 described an unexpected change in the *cis/trans*-selectivity of the Wadsworth–Emmons cyclopropanation (WEC) (Scheme 6.1). Given its reliability as a *trans*-selective reaction, this was investigated further and screening showed that the major contributors to the selectivity of the reaction were the steric bulk of the anion stabilising group (ASG) and the polarity of the solvent, with the temperature of the reaction also having some effect. There was also some evidence of epimerisation of the final product but this was a minor contributor. These results provide a basis from which to further develop the WEC reaction for the possible selective synthesis of *cis*-substituted cyclopropanes, which cannot currently be accessed by this facile method.

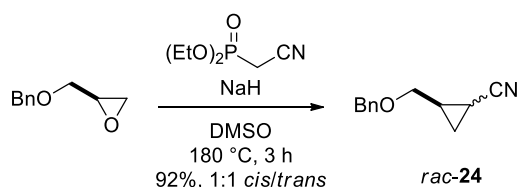

Scheme 6.1. Alteration in the *cis/trans*-selectivity of the WEC

Attempts at the nucleophilic ring-opening of cyclopropanes *via* iminium ion catalysis are also described in Chapter 2 (Scheme 6.2). Some progress was made, with evidence of iminium ion formation being observed. Unfortunately, however, the substrates and choice of nucleophile were unsuitable for the reaction, as evidenced by the reported procedure.⁴¹

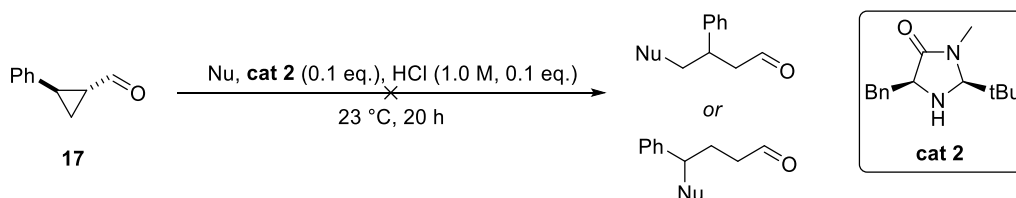

Scheme 6.2. Attempted iminium-ion catalysed nucleophilic ring-opening of cyclopropanes

Following this, Chapter 3 describes attempts to extend the WEC reaction for the synthesis of four-membered rings. This was attempted both intermolecularly and intramolecularly, requiring the synthesis of novel phosphonates containing an ether substituent on the α -carbon (Scheme 6.3).

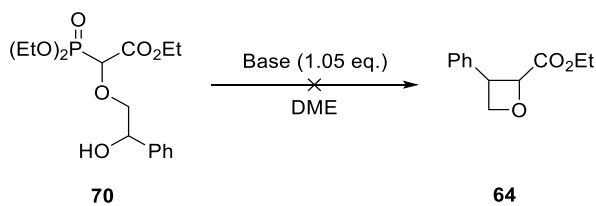

Scheme 6.3. Attempted intramolecular synthesis of oxetanes

Chapter 4 describes the successful development of the first metal catalysed protodecarboxylation of cyclopropanecarboxylic acids (Scheme 6.4). This was achieved using an affordable copper catalyst on a range of cyclopropanes, providing insight into the electronic requirements for ready decarboxylation.

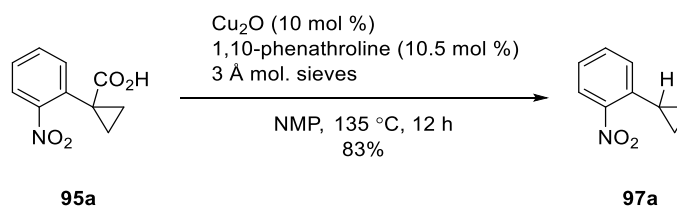

Scheme 6.4. Development of a catalytic method for the protodecarboxylation of cyclopropanecarboxylic acids

Significant decreases in the temperature required for decarboxylation, in comparison to thermal decarboxylation, were achieved, with unreactive electron-rich substrates, which showed no decarboxylation under thermal conditions, undergoing decarboxylation under catalytic conditions. The decarboxylation of the unreactive 2-phenyl substituted cyclopropanecarboxylic acid **95i** was also achieved, demonstrating the potential for further extension of this method to 1,2-substituted cyclopropanecarboxylic acids.

The final chapter described initial attempts at cross-coupling of cyclopropyl iodides with benzoic acids, which were carried out in the final months (Scheme 6.5). This showed that the reaction requires balancing of the two catalytic cycles – decarboxylation and oxidative addition – in order to enable transmetalation before degradation of the cyclopropane. These problems have been faced by many research groups and require extensive screening in order to identify the correct substrates, catalysts and solvents, among many other factors. Unfortunately, the time remaining was insufficient for a more in-depth investigation and the project was brought to a close.

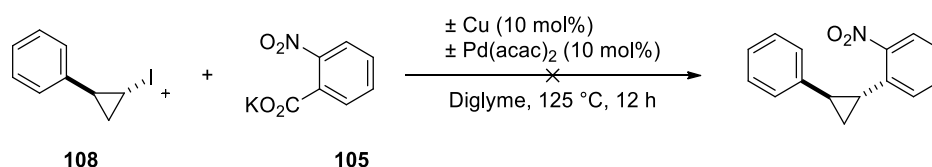

Scheme 6.5. Attempted development of a decarboxylative cross-coupling method with cyclopropyl iodides

However, several areas for further development have been identified throughout the thesis. As mentioned, it may be possible to further alter the selectivity of the WEC in order to afford the *cis*-substituted cyclopropanes by tuning the solvent, the ASG and the temperature of the reaction, as well as other possible factors such as the reaction time. As this was not the aim of the project, it was not developed further but the novelty of this finding merits further investigation.

In particular, the cross-coupling of cyclopropanes by a decarboxylative process would provide a more environmentally benign method to those commonly used. The main issue in this area is the degradation of the cyclopropane, which limits the time available for the decarboxylative cycle and oxidative addition to take place. This could be prevented by the use of cyclopropanes that are less ready to ring-open and fragment, such as those containing longer-chain alkyl substituents. There is also the possibility of reverting to the use of cyclopropanecarboxylic acids and developing an effective decarboxylation of 2-substituted cyclopropanecarboxylic acids, which could participate more readily in cross-coupling reactions due to their reduced steric hindrance. These compounds have been shown to be robust, showing no degradation at extremely high temperatures, and would thus be ideal for the development of a cross-coupling reaction.

Chapter 7 *Experimental Section*

General Experimental Details

Commercially available reagents were used as received without further purification. All reactions requiring anhydrous conditions were conducted in flame-dried apparatus under an atmosphere of argon. The molecular sieves used were Merck Millipore 3 Å, 1.6 mm rods, sodium aluminium silicate and were powdered and oven dried before use; analytical thin-layer chromatography (TLC) was performed on silica gel plates (0.25mm) precoated with a fluorescent indicator. Visualisation of the developed chromatogram was performed by fluorescence quenching and/or by potassium permanganate stain. Standard flash chromatography procedures were performed using Kieselgel 60 (40–63 μm). Residual solvent was removed using a static oil pump (< 1 mbar). Infrared spectra were recorded directly as neat liquids or solids on a Bruker Tensor 37 FTIR machine fitted with a PIKE MIRacle ATR accessory. Data are reported as follows: wavelength (cm⁻¹), intensity (s = strong, m = medium, w = weak, br = broad). ¹H and ¹³C NMR spectra were recorded in CDCl₃ at 400 and 100 respectively on Bruker AV400 machines. Chemical shifts (δ) are reported with the residual protonated solvent resonance as the internal standard (CDCl₃: δ_H 7.26; δ_C 77.2). ¹H NMR data are reported as follows: integration, chemical shift (δ), multiplicity (s = singlet, d = doublet, t = triplet, q = quartet, m = multiplet), coupling constants (Hz), and assignment. ¹H NMR signals were assigned using standard 2D NMR techniques. Coupling constants are reported as *J*_{HH}, *J*_{HP}, *J*_{HF}, *J*_{CP} and *J*_{CF} for H–H, H–P, H–F, C–P and C–F coupling, respectively. Where this is not specified, the coupling constant relates to H–H coupling. Mass spectrometry analysis was performed by the EPSRC National Mass Spectrometry Facility in Swansea on an LTQ Orbitrap XL instrument (ESI = electrospray ionisation; ACPI = atmospheric pressure chemical ionisation; + and – indicate positive and negative modes respectively). Petrol refers to the fraction boiling between 40–60 °C. Brine refers to a saturated aqueous solution of NaCl.

Experimental data for Chapter 2

Diethyl cyanomethylphosphonate 22

Prepared according to a modified literature procedure.¹⁵³

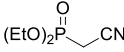
 Chloroacetonitrile (0.250 mL, 2.98 g, 4.00 mmol) was added to triethyl phosphite (10.0 mL, 58.3 mmol) at 22 °C and the solution was heated to 170 °C for 3 h. After cooling to room temperature, the product was purified by distillation *in vacuo* to give the title compound as a colourless oil (0.602 g, 3.40 mmol, 85%). Data corresponded to that reported in the literature;¹⁵³ bp 140–142 °C (6 mm Hg; lit.¹⁵⁴ 142–143 °C, 6–7 mm Hg); $\nu_{\max}/\text{cm}^{-1}$ 3474 m, 2988m, 2909m, 2256w (C≡N), 1638w, 1479m, 1371m, 1261s (P=O), 1098s (P–O), 974s; δ_{H} (400 MHz; CDCl₃) 4.26–4.18 (4H, m, 2 × CH₃CH₂O), 2.86 (2H, d, $J_{\text{HP}} = 21.0$ Hz, CH₂CN), 1.37 (6H, t, $J = 7.1$ Hz, 2 × CH₃); δ_{C} (100 MHz; CDCl₃) 112.7 (d, $J_{\text{CP}} = 11.3$ Hz, CN), 64.0 (d, $J_{\text{CP}} = 6.4$, CH₃CH₂O), 16.6 (d, $J_{\text{CP}} = 144.3$ Hz, CH₂CN), 16.4 (d, $J_{\text{CP}} = 6.0$ Hz, CH₃); δ_{P} (231 MHz; CDCl₃) 14.45.

General Procedure A: Wadsworth–Emmons synthesis of cyclopropyl esters

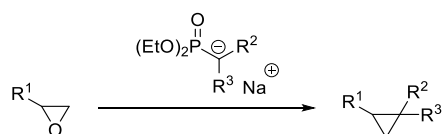

Prepared according to the literature procedure.^{42h} To a mixture of NaH in PhMe or DMSO was added the appropriate phosphonate dropwise. This mixture was stirred at 23 °C until the NaH dissolved, followed by addition of the appropriate epoxide and the reaction was then stirred at reflux for the specified amount of time. The reaction was allowed to cool to room temperature and the product was extracted three times with EtOAc and washed with sat. aq. NH₄Cl. The combined organic layers were dried (MgSO₄), filtered and concentrated *in vacuo*. The crude product was purified by flash column chromatography (SiO₂) to yield the cyclopropane.

Ethyl 2-phenylcyclopropanecarboxylate 5

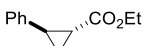
 Prepared according to General Procedure A with styrene oxide (3.80 mL, 4.01 g, 33.3 mmol), triethyl phosphonoacetate (13.1 mL, 14.8 g, 66.03 mmol) and NaH (1.81 g, 75.4 mmol) in PhMe (50.0 mL) for 20 h and purified by flash column chromatography (10% EtOAc in petrol) to give the title compound as a colourless oil (5.37 g, 28.2 mmol, 85%). Data corresponded to that reported in the literature;^{42h} $\nu_{\max}/\text{cm}^{-1}$ 2981w, 2362w, 2025 m, 1927m, 1722s (C=O), 1605w, 1542w, 1220s (C–O), 1179s (C–O), 1077s, 1041s, 1017s; δ_{H} (400 MHz; CDCl₃) 7.32–7.28 (2H, m, 2 × CH_{Ar}), 7.24–7.21 (1H, m, CH_{Ar}), 7.14–7.12 (2H, m, 2 × CH_{Ar}), 4.20 (2H, q, $J = 7.2$ Hz, CH₂CH₃), 2.55 (1H, ddd, $J = 10.4, 6.4, 4.2$ Hz, CHPh), 1.93 (1H, ddd, $J = 9.6, 5.2, 4.2$ Hz, CHCO₂Et), 1.63 (1H, m, CH(*H*)), 1.36–1.32 (1H, m, CH(*H*)), 1.31 (3H, t, $J = 7.1$ Hz, CH₃); δ_{C} (100 MHz; CDCl₃) 173.5 (CO₂Et), 140.3 (ArC_{quat}), 128.6 (ArCH), 126.6 (ArCH), 126.3 (ArCH), 60.8 (CH₂CH₃), 26.3 (CHPh), 24.3 (CHCO₂Et), 17.2 (CH₂), 14.4 (CH₃); m/z (nano-ESI+, (M + H)⁺, 100%) Found: 191.1067 C₁₂H₁₅O₂ requires: 191.1067.

2-((Benzyloxy)methyl)cyclopropanecarboxylate 19

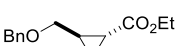
 Prepared according to General Procedure A with benzyl glycidyl ether (1.80 mL, 1.94 g, 11.8 mmol), triethyl phosphonoacetate (5.00 mL, 5.65 g, 25.2 mmol) and NaH (0.629 g, 26.2 mmol) in PhMe (17.0 mL) for 4 h and purified by flash column chromatography (10% EtOAc in petrol) to give the title compound as a colourless oil (2.41 g, 10.3 mmol, 87%). Data corresponded to that reported in the literature;^{42h} $\nu_{\max}/\text{cm}^{-1}$ 2930w, 2361w, 1929m, 1722s (C=O), 1496w, 1454w, 1219m (C–O), 1204m (C–O), 1179s (C–O), 1090m, 1043m; δ_{H} (400 MHz; CDCl₃) 7.28–7.18 (5H, m, 5 × CH_{Ar}), 4.44 (2H, s, PhCH₂), 4.04 (2H, dq, $J = 7.1, 1.6$ Hz, CO₂CH₂), 3.33 (1H, dd, $J = 10.4, 6.1$ Hz, BnOCH(*H*)), 3.29 (1H, dd, $J = 10.4, 6.5$ Hz, BnOCH(*H*)), 1.70–1.62 (1H, m, BnOCH₂CH), 1.51–1.45 (1H, m, CHCO₂Et), 1.17 (3H, t, $J = 7.1$ Hz, CH₃), 1.15–1.10 (1H, m, CHCH(*H*)CH), 0.78 (1H, ddd, $J = 10.6, 6.3, 4.4$ Hz, CHCH(*H*)CH); δ_{C} (100 MHz; CDCl₃) 173.9 (CO₂Et), 138.3 (ArC_{quat}), 128.5

(ArCH), 127.7 (ArCH), 72.7 (CO₂CH₂CH₃), 71.6 (BnOCH₂), 60.6 (PhCH₂), 21.7 (BnOCH₂CH), 18.6 (CHCO₂Et), 14.3 (CH₃), 13.0 (CH₂); *m/z* (nano-ESI⁺, (M + NH₄⁺), 100%) Found: 252.1598 C₁₄H₂₂O₃N requires: 252.1594.

2-Phenylcyclopropanecarbonitrile **23**

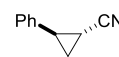
 Prepared according to General Procedure A with styrene oxide (0.095 mL, 0.100 g, 0.833 mmol), **22** (0.140 mL, 0.153 g, 0.865 mmol) and NaH (0.042 g, 1.75 mmol) in PhMe (1.25 mL) for 12 h and purified by flash column chromatography (10% EtOAc in petrol) to give the title compound as a yellow oil (0.056 g, 0.391 mmol, 47%); $\nu_{\max}/\text{cm}^{-1}$ 3050m, 2235s (C≡N), 1722m, 1584m, 1499s, 1461s, 1092s, 1078s, 1054s; δ_{H} (400 MHz; CDCl₃) 7.39–7.27 (3H, m, 3 × CH_{Ar}), 7.15–7.12 (2H, m, 2 × CH_{Ar}), 2.65 (1H, ddd, *J* = 11.4, 6.7, 4.8 Hz, CHPh), 1.66–1.55 (2H, m, CH(H) and CHCN), 1.47 (1H, ddd, *J* = 11.6, 6.7, 5.0 Hz, CH(H)); δ_{C} (100 MHz; CDCl₃) 137.6 (ArC_{quat}), 128.8 (ArCH), 127.4 (ArCH), 126.3 (ArCH), 121.0 (CN), 24.9 (CHPh), 15.3 (CH₂), 6.6 (CHCN); *m/z* (ESI⁺, M⁺, 100%) Found: 143.0727 C₁₀H₉N requires: 143.0730.

2-((Benzyloxy)methyl)cyclopropanecarbonitrile **24**

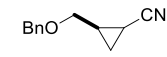
 Prepared according to General Procedure A with benzyl glycidyl ether (1.80 mL, 1.94 g, 11.8 mmol), **22** (4.04 mL, 4.42 g, 25.0 mmol) and NaH (0.629 g, 26.2 mmol) in DMSO (17.0 mL) for 3 h and purified by flash column chromatography (10% EtOAc in petrol) to give the title compound as a 1:1 ratio of the *cis*- and *trans*-diastereomers (2.04 g, 10.9 mmol, 92%). *Trans*-isomer obtained as a yellow oil (1.04 g, 5.56 mmol); $\nu_{\max}/\text{cm}^{-1}$ 3032w, 2864m, 2238m (C≡N), 1720w, 1453m, 1089s (C–O), 1074s (C–O), 1028m; δ_{H} (400 MHz; CDCl₃) 7.37–7.26 (5H, m, 5 × CH_{Ar}), 4.50 (2H, s, PhCH₂), 3.50 (1H, dd, *J* = 10.3, 5.10 Hz, BnOCH(H)), 3.38 (1H, dd, *J* = 10.3, 5.8 Hz, BnOCH(H)), 1.81–1.73 (1H, m, BnOCH₂CH), 1.36–1.31 (1H, m, CHCN), 1.23 (1H, ddd, *J* = 10.0, 5.4, 4.6 Hz, CH(H)), 1.04 (1H, ddd, *J* = 11.6, 6.2, 5.4 Hz, CH(H)); δ_{C} (100 MHz; CDCl₃) 137.8 (ArC_{quat}), 128.6 (ArCH), 128.0 (ArCH), 127.8 (ArCH), 121.5 (CN), 73.1 (PhCH₂), 69.6 (BnOCH₂), 20.7 (CHCH₂CH),

11.43 (BnOCH₂CH), 1.15 (CHCN). *Cis*-isomer obtained as a colourless oil (1.00 g, 5.35 mmol); $\nu_{\max}/\text{cm}^{-1}$ 3018w, 2864m, 2361m, 2338m, 2237m (C≡N), 1728w, 1454m, 1378m, 1354m, 1089s (C–O), 1028m; δ_{H} (400 MHz; CDCl₃) 7.40–7.28 (5H, m, 5 × CH_{Ar}), 4.58 (2H, dd, $J = 16.1, 11.6$ Hz, PhCH₂), 3.73 (1H, dd, $J = 10.4, 5.7$ Hz, BnOCH(*H*)), 3.51 (1H, dd, $J = 10.4, 7.7$ Hz, BnOCH(*H*)), 1.68–1.53 (2H, m, BnOCH and CHCN), 1.25–1.19 (1H, m, CH(*H*)), 0.99–0.95 (1H, m, CH(*H*)); δ_{C} (100 MHz; CDCl₃) 137.9 (ArC_{quat}), 128.6 (ArCH), 128.0 (ArCH), 127.9 (ArCH), 120.0 (CN), 73.5 (PhCH), 70.4 (BnOCH₂), 18.3 (BnOCH₂CH), 11.7 (CHCH₂CH), 2.2 (CHCN); m/z (nano-ESI+, (M + NH₄⁺), 100%) Found: 205.1336 C₁₂H₁₇ON₂ requires: 205.1335.

1-Methyl-2-phenylcyclopropanecarbonitrile 25

 Prepared according to General Procedure A with styrene oxide (0.138 mL, 0.145 g, 1.21 mmol), diethyl (1-cyanoethyl)phosphonate¹⁵⁵ (0.461 mL, 0.500 g, 2.62 mmol) and NaH (0.065 g, 2.71 mmol) in DMSO (20.0 mL) for 20 h and purified by flash column chromatography (gradient 2.5–5% Et₂O in petrol) to give the title compound as a yellow oil (0.096 g, 0.611 mmol, 50%); $\nu_{\max}/\text{cm}^{-1}$ 2937w, 2232m (C≡N), 1499m, 1451m, 1084w, 908s; δ_{H} (400 MHz; CDCl₃) 7.34–7.25 (3H, m, 3 × CH_{Ar}), 7.19 (2H, d, $J = 7.4$ Hz, 2 × CH_{Ar}), 2.80 (1H, dd, $J = 9.3, 7.2$ Hz, PhCH), 1.67 (1H, dd, $J = 9.3, 5.7$ Hz, 1 × CH(*H*)), 1.24 (1H, dd, $J = 7.2, 5.7$ Hz, 1 × CH(*H*)), 1.04 (3H, s, CH₃); δ_{C} (100 MHz; CDCl₃) 134.2 (ArC_{quat}), 129.2 (ArCH), 128.5 (ArCH), 127.5 (ArCH), 124.5 (CN), 29.8 (PhCH), 18.3 (CH₂), 16.1 (CH₃), 10.1 (CCN); m/z (nano-ESI+, (M – H)⁺, 100%) Found: 156.0805 C₁₁H₁₀N requires: 156.0808.

2-((Benzyloxy)methyl)-1-methylcyclopropanecarbonitrile 26

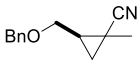
 Prepared according to General Procedure A with benzyl glycidyl ether (0.185 mL, 0.199 g, 1.21 mmol), diethyl (1-cyanoethyl)phosphonate¹⁵⁵ (0.461 g, 0.500 g, 2.62 mmol) and NaH (0.065 g, 2.71 mmol) in DMSO (20.0 mL) at 110 °C for 20 h to give the *title compound* as an

inseparable 1:1.5 mixture of *cis*- and *trans*- diastereomers (0.224 g, 1.11 mmol, 92%); δ_{H} (400 MHz; CDCl_3) 7.37–7.26 (12.5H, m, $12.5 \times \text{CH}_{\text{Ar}}$), 4.61–4.48 (5H, m, $2.5 \times \text{PhCH}_2$), 3.72–3.29 (5H, m, $2.5 \times \text{BnOCH}_2$), 1.83–1.76 (1H, m, $1 \times \text{BnOCH}_2\text{CH}$), 1.44–1.32 (2.5H, m, $1.5 \times \text{BnOCH}_2\text{CH}$, $1 \times \text{CH}(\text{H})$), 1.40 (4.5H, s, $1.5 \times \text{CH}_3$), 1.36 (3H, s, $1 \times \text{CH}_3$), 1.09–1.06 (1.5H, m, $1.5 \times \text{CH}(\text{H})$), 0.99–0.95 (1.5H, m, $1.5 \times \text{CH}(\text{H})$), 0.69–0.66 (1H, m, $1 \times \text{CH}(\text{H})$).

General Procedure B: Reduction of cyclopropyl ester to the alcohol

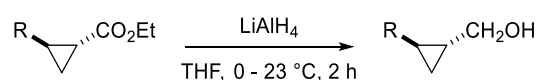

To a mixture of LiAlH_4 (x g, 1.50 equiv.) in THF ($2.00 \text{ mL mmol}^{-1}$) was added the appropriate cyclopropyl ester (1.00 equiv.) dropwise. The mixture was stirred at $23 \text{ } ^\circ\text{C}$ for 2 h followed by successive dropwise addition of water ($x \text{ mL}$), NaOH ($x \text{ mL}$) and water ($3x \text{ mL}$) at $0 \text{ } ^\circ\text{C}$, with stirring for 15 min between each addition. The solution was then filtered, dried (MgSO_4), refiltered and concentrated *in vacuo*. The crude product was purified by flash column chromatography (SiO_2) to yield the alcohol.

(2-Phenylcyclopropyl)methanol 20

Prepared according to General Procedure B with **5** (2.15 g, 11.3 mmol) and LiAlH_4 (0.643 g, 17.0 mmol) in THF (23 mL) and purified by flash column chromatography (30% EtOAc in petrol) to give the title compound as a yellow oil (1.62 g, 10.9 mmol, 96%); $\nu_{\text{max}}/\text{cm}^{-1}$ 3330br (O–H), 3064m, 3003m, 1604m, 1497s, 1241w, 1031s, 1017s; δ_{H} (400 MHz; CDCl_3) 7.25 (2H, dd, $J = 7.7, 7.3 \text{ Hz}$, $2 \times \text{CH}_{\text{Ar}}$), 7.15 (1H, m, CH_{Ar}), 7.07 (2H, d, $J = 7.7 \text{ Hz}$, $2 \times \text{CH}_{\text{Ar}}$), 3.65–3.57 (2H, m, CH_2OH), 1.84–1.80 (1H, m, PhCH), 1.55 (1H, s, OH), 1.47–1.42 (1H, m, CHCH_2OH), 0.98–0.90 (2H, m, CHCH_2CH); δ_{C} (100 MHz; CDCl_3) 142.4 (ArC_{quat}), 128.4 (ArCH), 125.9 (ArCH), 125.7 (ArCH), 66.6 (CH_2OH), 25.3 (CHCH_2OH), 21.3 (PhCH), 13.8 (CHCH_2CH); m/z (nano-ESI+, M^+ , 100%) Found: 148.0881 $\text{C}_{10}\text{H}_{12}\text{O}$ requires: 148.0883.

((2-Benzyloxymethyl)cyclopropyl)methanol **21**

Prepared according to General Procedure B with **19** (1.88 g, 8.03 mmol) and LiAlH₄ (0.457 g, 12.0 mmol) in THF (16 mL) and purified by flash column chromatography (30% EtOAc in petrol) to give the title compound as a colourless oil (0.66 g, 3.4 mmol, 42%); $\nu_{\max}/\text{cm}^{-1}$ 3383br (O–H), 3064w, 3003w, 2858m, 2362w, 1496m, 1454m, 1364m, 1071s (C–O), 1028s (C–O); δ_{H} (400 MHz; CDCl₃) 7.16–7.08 (5H, m, 5 × CH_{Ar}), 4.35 (2H, s, PhCH₂O), 3.32–3.07 (2H, m, BnOCH₂), 1.88 (1H, s, OH), 0.86–0.80 (2H, m, 2 × CH), 0.33–0.27 (2H, m, CHCH₂CH); δ_{C} (100 MHz; CDCl₃) 138.5 (ArC_{quat}), 128.5 (ArCH), 127.8 (ArCH), 127.7 (ArCH), 73.6 (PhCH₂), 72.7 (BnOCH₂), 19.9 (CHCH₂OH), 16.9 (BnOCH₂CH), 8.2 (CHCH₂CH); m/z (nano-ESI⁺, (M + NH₄⁺), 100%) Found: 210.1490 C₁₂H₂₀O₂N requires: 210.1489.

General Procedure C: Swern oxidation of cyclopropyl alcohols to aldehydes

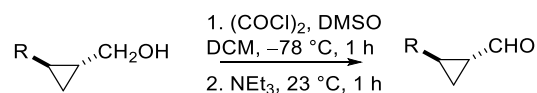

To a solution of (COCl)₂ (2.00 equiv.) in CH₂Cl₂ (23.0 mL mmol⁻¹) at -78 °C was added DMSO (4.00 equiv.) and the solution was stirred at -78 °C for 20 min. The appropriate cyclopropyl alcohol (1.00 equiv.) was added in one portion and the solution was stirred for a further 40 min (the temperature was not allowed to rise above -66 °C), followed by addition of NEt₃ (4.00 equiv.). The reaction mixture was allowed to warm to room temperature followed by stirring for 1 h. The product was extracted in water and washed three times with ether. The combined organic layers were then dried (MgSO₄), filtered and concentrated *in vacuo*. The crude product was purified by flash column chromatography (SiO₂) to yield the alcohol.

General Procedure D: Reduction of the cyclopropyl nitrile to the aldehyde

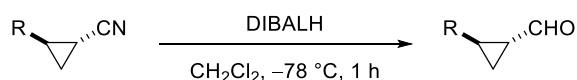

To a solution of the appropriate cyclopropyl nitrile (1.00 equiv.) in CH_2Cl_2 (12.5 mL mmol^{-1}) at $-78\text{ }^\circ\text{C}$ was added DIBALH (1.00 M in PhMe, 1.50 equiv., x mmol) dropwise followed by stirring at $-78\text{ }^\circ\text{C}$ for 1 h. The solution was then diluted with ether and allowed to warm to room temperature. The reaction was then worked up by successive addition of H_2O ($0.04x$ mL), NaOH (15% w/v, $0.04x$ mL) and H_2O ($0.10x$ mL), then stirred for 15 min followed by addition of MgSO_4 and stirring for a further 15 min. The mixture was filtered and concentrated *in vacuo*. The crude product was then purified by flash column chromatography (SiO_2) to yield the alcohol.

2-Phenylcyclopropanecarbaldehyde **17**

 Prepared according to General Procedure C with **20** (0.164 g, 1.11 mmol), $(\text{COCl})_2$ (0.187 mL, 2.22 mmol), DMSO (0.315 mL, 4.44 mmol) and NEt_3 (0.619 mL, 4.44 mmol) in CH_2Cl_2 (25.0 mL) and purified by flash column chromatography (5% EtOAc in petrol) to give the title compound as a colourless oil (0.108 g, 0.74 mmol, 67%); $\nu_{\text{max}}/\text{cm}^{-1}$ 3029w, 2919m, 2841m (OC-H), 2726m (OC-H), 2361m, 2340m, 1686s (C=O), 1497m, 1460m, 1326m, 1079s (C-O), 1024s (C-O); δ_{H} (400 MHz; CDCl_3) 9.34 (1H, d, $J = 4.6$ Hz, CHO), 7.31–7.21 (3H, m, $3 \times \text{CH}_{\text{Ar}}$), 7.11 (2H, d, $J = 7.7$ Hz, CH_{Ar}), 2.63 (1H, ddd, $J = 9.1, 6.7, 4.1$ Hz, BnOCH_2CH), 2.20–2.15 (1H, m, CHCHO), 1.76–1.71 (1H, m, CHCH(H)CH), 1.55–1.50 (1H, m, CHCH(H)CH); δ_{C} (100 MHz; CDCl_3) 199.8 (CHO), 139.1 (ArC_{quat}), 128.8 (ArCH), 127.0 (ArCH), 126.4 (ArCH), 33.9 (CHCH_2OH), 26.8 (BnOCH_2CH), 16.6 (CHCH_2CH); m/z (nano-ESI+, M^+ , 100%) Found: 146.0726 $\text{C}_{10}\text{H}_{10}\text{O}$ requires: 146.0726

Prepared according to General Procedure D with **23** (0.397 g, 2.77 mmol) and DIBALH (4.16 mL, 4.16 mmol) in CH_2Cl_2 (35 mL) and purified by flash column chromatography (5% EtOAc in petrol) to give the title compound as a colourless

oil (0.385 g, 2.63 mmol, 95%). Data matched that prepared by the alternative General Procedure C.

2-((Benzyloxy)methyl)cyclopropanecarbaldehyde **18**

 Prepared according to General Procedure C with **21** (0.040 g, 0.208 mmol), (COCl)₂ (0.035 mL, 0.42 mmol), DMSO (0.059 mL, 0.832 mmol) and NEt₃ (0.116 mL, 0.832 mmol) in CH₂Cl₂ (5.0 mL) and purified by flash column chromatography (5% EtOAc in petrol) to give the title compound as a colourless oil (0.034 g, 0.179 mmol, 86%); $\nu_{\max}/\text{cm}^{-1}$ 3032w, 2925m, 2856m (OC-H), 2730m (OC-H), 2360m, 2341m, 1704s (C=O), 1496m, 1454m, 1359m, 1077s (C-O), 1028s (C-O); δ_{H} (400 MHz; CDCl₃) 9.12 (1H, d, J = 5.02 Hz, CHO), 7.37–7.29 (5H, m, 5 × CH_{Ar}), 4.52 (2H, s, PhCH₂O), 3.50 (1H, dd, J = 10.3, 5.6 Hz, 1 of BnOCH₂), 3.42 (1H, dd, J = 10.3, 6.0 Hz, 1 of BnOCH₂), 1.87–1.79 (2H, m, BnOCH₂CH and CHCHO), 1.35–1.31 (1H, m, CHCH(H)CH), 1.10–1.06 (2H, ddd, J = 4.77, 6.75, 11.44 Hz, CHCH(H)CH); δ_{C} (100 MHz; CDCl₃) 200.5 (CHO), 138.1 (ArC_{quat}), 128.6 (ArCH), 127.9 (ArCH), 127.8 (ArCH), 73.0 (PhCH₂), 71.1 (BnOCH₂), 28.2 (CHCH₂OH), 21.7 (BnOCH₂CH), 12.6 (CHCH₂CH); m/z (nano-ESI+, (M + NH₄⁺), 100%) Found: 208.1333 C₁₂H₁₈O₂N requires: 208.1332.

Prepared according to General Procedure D with **24** (3.74 g, 20.0 mmol) and DIBALH (30.0 mL, 30.0 mmol) in CH₂Cl₂ (250 mL) and purified by flash column chromatography (5% EtOAc in petrol) to give the title compound as a colourless oil (3.44 g, 18.1 mmol, 91%). Data matched that prepared by the alternative General Procedure C.

Experimental data for Chapter 3

Ethyl 2-(diethoxyphosphoryl)-2-hydroxyacetate 55

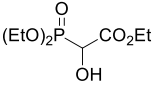
 Prepared according to a modified literature procedure.⁸⁵ To a solution of diethyl phosphite (2.58 mL, 2.77 g, 20.0 mmol) in PhMe (5.00 mL) at 0 °C was added NEt₃ (8.38 mL, 6.08 g, 60.1 mmol) slowly. This was stirred at 0 °C for 5 min, followed by addition of ethyl glyoxalate (50% in PhMe, 3.97 mL, 20.0 mmol). The reaction mixture was allowed to warm to room temperature and stirred for 1 h, followed by acidification to pH 6 (33% aq. HCl). The layers were separated and the aqueous layer was washed with CH₂Cl₂ (3 × 5 mL). The combined organics were dried (MgSO₄), filtered and concentrated *in vacuo*. The crude product was purified by flash column chromatography (SiO₂, 50% EtOAc in petrol) to give the title compound as a colourless oil (4.10 g, 17.1 mmol, 85%). Data corresponded to that reported in the literature;¹⁵⁶ $\nu_{\max}/\text{cm}^{-1}$ 3264w (O–H), 2985w, 1745s (C=O), 1445m, 1392m, 1239s (P=O), 1098m, 1017s (P–O), 973s; δ_{H} (400 MHz; CDCl₃) 4.49 (1H, dd, $J_{\text{HH}} = 1.5$ Hz, $J_{\text{HP}} = 16.3$ Hz, CH), 4.26–4.19 (2H, m, CO₂CH₂CH₃), 4.18–4.09 (4H, m, 2 × P(O)OCH₂CH₃), 3.61 (1H, br, OH), 1.28–1.22 (9H, m, 3 × CH₃); δ_{C} (100 MHz; CDCl₃) 69.3 (d, $J_{\text{CP}} = 154.8$ Hz, CH), 63.7 (2 × d, $J_{\text{CP}} = 15.0$ and 15.1 Hz, 1 × P(O)CH₂CH₃), 16.3 (2 × P(O)CH₂CH₃), 14.0 (CO₂CH₂CH₃); δ_{P} (231 MHz; CDCl₃) 16.23.

Ethyl 2-(diethoxyphosphoryl)-2-hydroxypropanoate 56

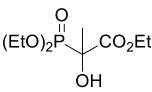
 Prepared according to a modified literature procedure.⁸⁵ To a solution of diethyl phosphite (2.58 mL, 2.77 g, 20.0 mmol) in PhMe (5.00 mL) at 0 °C was added NEt₃ (8.38 mL, 6.08 g, 60.1 mmol) slowly. This was stirred at 0 °C for 5 min, followed by addition of ethyl pyruvate (2.22 mL, 2.32 g, 20.0 mmol). The reaction mixture was allowed to warm to room temperature and stirred for 1 h, followed by acidification to pH 6 (HCl). The layers were separated and the aqueous layer was washed with CH₂Cl₂ (3 × 5 mL). The combined organics were dried (MgSO₄), filtered and concentrated *in vacuo*. The crude product was purified by flash column

chromatography (SiO₂, 50% EtOAc in petrol) to give the title compound as a colourless oil (4.54 g, 17.9 mmol, 90%). Data corresponded to that reported in the literature;¹⁵⁷ $\nu_{\text{max}}/\text{cm}^{-1}$ 3495m (O–H), 2983m, 1732s (C=O), 1392m, 1243s (P=O), 1148s, 1044s (P–O), 970s; δ_{H} (400 MHz; CDCl₃) 4.29–4.22 (2H, m, 1 × CH₂), 4.20–4.12 (4H, m, 2 × CH₂), 3.78 (1H, br, OH), 1.58 (3H, d, $J = 16.01$ Hz, CCH₃), 1.30–1.25 (9H, m, 3 × CH₂CH₃); δ_{C} (100 MHz; CDCl₃) 172.5 (d, $J_{\text{CP}} = 5.0$ Hz, CO₂Et), 74.4 (d, $J_{\text{CP}} = 160.3$ Hz, (EtO)₂P(O)CH), 63.9 (d, $J_{\text{CP}} = 7.1$ Hz, 1 × OCH₂CH₃), 63.6 (d, $J_{\text{CP}} = 7.2$ Hz, 1 × OCH₂CH₃), 62.9 (CO₂CH₂CH₃), 21.2 (CCH₃), 16.48 (d, $J_{\text{CP}} = 5.4$ Hz, 1 × POCH₂CH₃), 16.46 (d, $J_{\text{CP}} = 5.5$ Hz, 1 × POCH₂CH₃), 14.10 (CO₂CH₂CH₃); δ_{P} (231 MHz; CDCl₃) 18.18.

Ethyl 2-diazo-2-(diethoxyphosphoryl)acetate 72

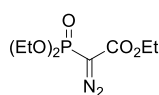

To a solution of NaN₃ (2.55 g, 39.3 mmol) in acetone/water (70.0/20.0 mL) at –5 °C was added TsCl (7.49 g, 39.3 mmol). The mixture was allowed to warm to room temperature and was stirred for 20 h. The acetone was removed *in vacuo* and the product was extracted in EtOAc (2 × 100 mL). The combined organics were dried (MgSO₄), filtered and concentrated *in vacuo* to give TsN₃, which was used without further purification.

Triethyl phosphonoacetate (7.32 mL, 8.27 g, 36.9 mmol) was added dropwise to NaH (0.930 g, 38.8 mmol) in PhMe/THF (100/35.0 mL) at 0 °C under an atmosphere of nitrogen. The ice bath was then removed and the reaction mixture was stirred for 1 h. TsN₃ (7.13 g, 36.2 mmol) was added and the mixture was allowed to warm to room temperature and was stirred for a further 20 h. The reaction mixture was then filtered through Celite[®] and concentrated *in vacuo*. The crude product was purified by flash column chromatography (SiO₂, 35% EtOAc in petrol) to give the *title compound* as a yellow oil (5.60 g, 22.4 mmol, 62%); $\nu_{\text{max}}/\text{cm}^{-1}$ 2986m, 2125s (N=N⁺), 1701s (C=O), 1444m, 1368m, 1274s (P=O), 1097s, 1014s (P–O), 976s; δ_{H} (400 MHz; CDCl₃) 4.24–4.09 (6H, m, 3 × CH₂), 1.33–1.22 (9H, m, 3 × CH₃); δ_{C} (100 MHz; CDCl₃) 163.3 (d, $J_{\text{CP}} = 12.4$ Hz, CO₂Et), 63.6 (d, $J_{\text{CP}} = 5.6$ Hz, 2 × POCH₂CH₃), 61.6 (CO₂CH₂CH₃), 53.7 (d, $J_{\text{CP}} = 228.8$ Hz, CN₂), 16.1 (d, $J_{\text{CP}} = 6.6$ Hz, 2 × POCH₂CH₃), 14.3 (CO₂CH₂CH₃);

δ_P (231 MHz; CDCl₃) 9.97; m/z (nano-ESI+, (M + Na⁺), 100%) Found: 273.0607
C₈H₁₅O₅N₂PNa requires: 273.0611.

1-Phenylethane-1,2-diol **73**

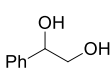
 Prepared according to the literature procedure⁹² to give the title compound as white crystals (5.48 g, 39.7 mmol, 99%). mp 62–64 °C (from Et₂O; lit.⁹² 61 °C); $\nu_{\max}/\text{cm}^{-1}$ 3191m (O–H), 3061m (O–H), 2931w, 1603w, 1448m, 1340m, 1268m, 1194m, 1088s, 1052s, 913s; δ_H (400 MHz; CDCl₃) 7.38–7.28 (5H, m, 5 × CH_{Ar}), 4.83 (1H, dd, J = 8.1, 3.3 Hz, CH), 3.77 (1H, dd, J = 11.2, 3.3 Hz, 1 of CH₂), 3.67 (1H, dd, J = 11.2, 8.1 Hz, 1 of CH₂), 2.67 (1H, br, CHO_H), 2.22 (1H, br, CH₂OH); δ_C (100 MHz; CDCl₃) 140.6 (ArC_{quat}), 128.7 (ArCH), 128.2 (ArCH), 126.2 (ArCH), 74.8 (CH), 68.2 (CH₂).

1,2-(di(*tert*-Butyldimethylsilyloxy))-1-phenylethane **76**

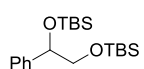
 A solution of **73** (2.76 g, 20.8 mmol), TBSCl (9.47 g, 62.8 mmol) and imidazole (8.56 g, 125.7 mmol) in CH₂Cl₂ (130 mL) were stirred at 22 °C for 3 h. The reaction mixture was washed with H₂O (3 × 50 mL) and brine (20 mL), dried (MgSO₄), filtered and concentrated *in vacuo* to give the title compound as a colourless oil (7.18 g, 19.6 mmol, 98%). Data corresponded to that reported in the literature;¹⁵⁸ $\nu_{\max}/\text{cm}^{-1}$ 2955m, 2929m, 2857m, 1493w, 1463m, 1389m, 1254s (Si–CH₃), 1127s (C–O), 1095s(C–O), 1076s, 966s; δ_H (400 MHz; CDCl₃) 7.34–7.20 (5H, m, 5 × CH_{Ar}), 4.69 (1H, dd, J = 7.0, 5.2 Hz, CH), 3.66 (1H, dd, J = 10.1, 7.0 Hz, 1 of CH₂), 3.54 (1H, dd, J = 10.1, 5.2 Hz, 1 of CH₂), 0.88 (9H, s, 1 × SiC(CH₃)₃), 0.85 (9H, s, 1 × SiC(CH₃)₃), 0.06 (3H, s, 1 × SiCH₃), 0.04 (3H s, 1 × SiCH₃), –0.056 (3H, s, 1 × SiCH₃), –0.061 (3H, s, 1 × SiCH₃); δ_C (100 MHz; CDCl₃) 142.9 (ArC_{quat}), 128.0 (ArCH), 127.3 (ArCH), 126.6 (ArCH), 76.3 (CH), 70.2 (CH₂), 26.1 (3 × SiC(CH₃)₃), 26.0 (3 × SiC(CH₃)₃), 18.6 (1 × SiC(CH₃)₃), 18.5 (1 × SiC(CH₃)₃), –4.5 (1 × SiCH₃), –4.6 (1 × SiCH₃), –5.3 (1 × SiCH₃), –5.4 (1 × SiCH₃).

2-((*tert*-Butyldimethylsilyl)oxy)-2-phenylethanol **75**

75 (7.51 g, 20.0 mmol) and FeCl₃ (3.24 g, 20.0 mmol) in MeOH (20.0 mL) were stirred at 22 °C for 1 h. The solvent was then removed *in vacuo* and the residue was dissolved in CH₂Cl₂ (20 mL). The solution was washed with sat. aq. NH₄Cl (10 mL) and the organic layer was dried (MgSO₄), filtered and concentrated *in vacuo*. The crude product was then purified by flash column chromatography (SiO₂, 20% EtOAc in petrol) to give the title compound as a colourless oil (2.35 g, 9.32 mmol, 47%). Data corresponded to that reported in the literature;¹⁵⁹ $\nu_{\max}/\text{cm}^{-1}$ 3430br (O–H), 2955m, 2929m, 2857m, 1493w, 1472m, 1389m, 1253s (Si–CH₃), 1098s (C–O), 1058s(C–O), 1006s, 951s; δ_{H} (400 MHz; CDCl₃) 7.29–7.19 (5H, m, 5 × CH_{Ar}), 4.71 (1H, dd, $J = 7.1, 4.7$ Hz, CH), 3.55–3.52 (2H, m, CH₂), 2.05 (1H, br, OH), 0.86 (9H, s, 3 × SiC(CH₃)₃), 0.01 (3H, s, 1 × SiCH₃), –0.15 (3H, s, 1 × SiCH₃); δ_{C} (100 MHz; CDCl₃) 141.6 (ArC_{quat}), 128.4 (ArCH), 127.8 (ArCH), 126.4 (ArCH), 76.0 (CH), 69.1 (CH₂), 26.0 (SiC(CH₃)₃), 18.3 (SiC(CH₃)₃), –4.4 (1 × SiCH₃), –4.8 (1 × SiCH₃).

Ethyl 2-(2-((*tert*-butyldimethylsilyl)oxy)-2-phenylethoxy)-2-(diethoxyphosphoryl)acetate **77**

To a mixture of **75** (0.342 g, 1.37 mmol) and Rh₂(OAc)₄ (3.00 mg, 6.79 μmol) in PhMe (1.50 mL) under an argon atmosphere was added **72** (0.375 g, 1.56 mmol). This was stirred at 110 °C for 24 h. The reaction was allowed to cool to room temperature and was purified directly by flash column chromatography (SiO₂, 10% EtOAc in petrol) to give the *title compound* as a yellow oil and a 1:1 mixture of diastereomers (0.275 g, 0.580 mmol, 42%); $\nu_{\max}/\text{cm}^{-1}$ 2930m, 2857m, 1748s (C=O), 1472m, 1391m, 1254s (P=O), 1162s, 1132s (C–O), 1101s (C–O), 1022s (P–O), 971s; δ_{H} (400 MHz; CDCl₃) 7.45–7.31 (10H, m, 10 × CH_{Ar}), 5.01 (1H, dd, $J = 7.4, 4.5$ Hz, 1 × CHPh), 4.98 (1H, dd, $J = 6.8, 4.9$ Hz, 1 × CHPh), 4.49 (d, $J_{\text{HP}} = 17.9$ Hz, 1 × (EtO)₂P(O)CH), 4.46 (d, $J_{\text{HP}} = 17.2$ Hz, 1 × (EtO)₂P(O)CH), 4.39–4.10 (12H, m, 6 × CH₂CH₃), 3.90 (1H, dd, $J = 9.8, 6.8$ Hz, 1 × OCH(H)CHPh), 3.75 (1H, dd, $J = 9.9, 4.5$ Hz, 1 × OCH(H)CHPh), 3.69 (1H, dd, $J = 9.9, 7.4$ Hz, 1

\times OCH(*H*)CHPh), 3.66 (1H, dd, $J = 9.8, 4.9$ Hz, $1 \times$ OCH(*H*)CHPh), 1.43–1.33 (18H, m, $6 \times$ CH₂CH₃), 0.96 (18H, s, $2 \times$ SiC(CH₃)₃), 0.18 (3H, s, $1 \times$ SiCH₃), 0.15 (3H, s, $1 \times$ SiCH₃), 0.00 (6H, s, $2 \times$ SiCH₃); δ_C (100 MHz; CDCl₃) 167.4 (d, $J_{CP} = 1.2$ Hz, CO₂Et) 167.3 (d, $J_{CP} = 1.4$ Hz, CO₂Et), 142.0 (ArC_{quat}), 141.8 (ArC_{quat}), 128.2 ($2 \times$ ArCH), 127.8 ($2 \times$ ArCH), 126.6 ($2 \times$ ArCH), 78.6–78.4 (m, $2 \times$ OCH₂CH), 78.1 (d, $J_{CP} = 155.6$ Hz, $2 \times$ (EtO)₂P(O)CH), 74.5 ($1 \times$ OCH₂CH), 74.4 ($1 \times$ OCH₂CH), 63.7–63.6 (m, $4 \times$ POCH₂CH₃), 61.8 ($2 \times$ CO₂CH₂CH₃), 25.9 ($6 \times$ SiC(CH₃)₃), 18.3 ($2 \times$ SiC(CH₃)₃), 16.5–16.4 (m, $4 \times$ POCH₂CH₃), 14.3 ($1 \times$ CO₂CH₂CH₃), 14.2 ($1 \times$ CO₂CH₂CH₃), –4.7 ($2 \times$ SiCH₃), –4.8 ($2 \times$ SiCH₃); δ_P (231 MHz; CDCl₃) 13.97, 14.05; m/z (nano-ESI+, (M + NH₄⁺), 100%) Found: 492.2533 C₂₂H₄₃O₇NPSi requires: 492.2541.

Ethyl 2-(diethoxyphosphoryl)-2-(2-hydroxy-2-phenylethoxy)acetate **70**

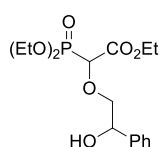

To a mixture of **77** (4.74 g, 10.0 mmol) in THF (25.0 mL) in a plastic reaction flask was added HCl (35%, 4.20 mL, 44.0 mmol), H₂O (5.30 mL) and KF (0.740 g, 12.7 mmol). The mixture was stirred at 22 °C for 12 h, followed by addition of brine (20.0 mL).

The aqueous layer was washed with CH₂Cl₂ and the combined organics were dried (MgSO₄), filtered and concentrated *in vacuo*. The crude product was purified by flash column chromatography (SiO₂, 30% EtOAc in petrol) to give the *title compound* as a yellow oil and a 1:1 mixture of diastereomers (3.51 g, 9.75 mmol, 98%); ν_{max}/cm^{-1} 3400w (O–H), 2935m, 1746s (C=O), 1496m, 1394m, 1222s (P=O), 1165s, 1129s (C–O), 1099s (C–O), 1019s (P–O), 979s; δ_H (400 MHz; CDCl₃) 7.39–7.25 (10H, m, $10 \times$ CH_{Ar}), 4.97 (1H, dd, $J = 9.0, 2.8$ Hz, $1 \times$ CHPh), 4.96 (1H, dd, $J = 9.0, 2.8$ Hz, $1 \times$ CHPh), 4.46 (d, $J_{HP} = 19.3$ Hz, $1 \times$ (EtO)₂P(O)CH), 4.41 (d, $J_{HP} = 19.2$ Hz, $1 \times$ (EtO)₂P(O)CH), 4.37–4.26 (4H, m, $2 \times$ CO₂CH₂CH₃), 4.15 (8H, m, $4 \times$ POCH₂CH₃), 4.00 (1H, ddd, $J_{HH} = 10.5, 2.8$ and $J_{PH} = 0.9$ Hz, $1 \times$ OCH(*H*)CHPh), 3.88 (1H, dd, $J = 10.3, 2.8$ Hz, $1 \times$ OCH(*H*)CHPh), 3.58 (1H, dd, $J = 10.3, 9.0$ Hz, $1 \times$ OCH(*H*)CHPh), 3.54 (1H, dd, $J = 10.5, 9.0$ Hz, $1 \times$ OCH(*H*)CHPh), 1.37–1.30 (18H, m, $4 \times$ POCH₂CH₃ and $2 \times$ CO₂CH₂CH₃); δ_C (100 MHz; CDCl₃) 167.9 (d, $J = 1.8$ Hz, CO₂Et) 167.7 (d, $J = 2.7$ Hz, CO₂Et), 139.7 (ArC_{quat}), 139.6 (ArC_{quat}), 128.6 (ArCH), 128.5 (ArCH),

128.0 (2 × ArCH), 126.4 (ArCH), 126.3 (ArCH), 80.1 (d, $J_{CP} = 9.7$ Hz, 1 × OCH₂CH) 79.4 (d, $J_{CP} = 10.5$ Hz, 1 × OCH₂CH), 77.9 (d, $J_{CP} = 157.3$ Hz, 1 × (EtO)₂P(O)CH), 77.0 (d, $J_{CP} = 158.4$ Hz, 1 × (EtO)₂P(O)CH), 73.0 (1 × OCH₂CH), 72.4 (1 × OCH₂CH), 64.3 (d, $J_{CP} = 6.3$ Hz, 2 × POCH₂CH₃), 63.9 (d, $J_{CP} = 6.5$ Hz, 1 × POCH₂CH₃), 63.8 (d, $J_{CP} = 6.2$ Hz, 1 × POCH₂CH₃), 62.4 (1 × CO₂CH₂CH₃), 62.3 (1 × CO₂CH₂CH₃), 16.6 (d, $J_{CP} = 5.9$ Hz, 2 × POCH₂CH₃), 16.5 (d, $J_{CP} = 6.0$ Hz, 2 × POCH₂CH₃), 14.3 (2 × CO₂CH₂CH₃); δ_P (231 MHz; CDCl₃) 14.85, 14.22; m/z (nano-ESI+, (M + Na⁺), 100%) Found: 383.1226 C₁₆H₂₅O₇PNa requires: 383.1225.

Diethyl (amino(phenyl)methyl)phosphonate **79**

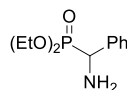

 Prepared according to the literature procedure⁹³ to give the title compound as a yellow oil (4.14 g, 17.0 mmol, 85%). Data corresponded to that reported in the literature;¹⁶⁰ ν_{max}/cm^{-1} 3378m (N–H), 3293m (N–H), 2933m, 2909w, 1680w, 1604m (N–H), 1455m, 1370m, 1223s (P=O), 1164m (C–N), 1099m, 1022s (P–O), 961s; δ_H (400 MHz; CDCl₃) 7.46 (2H, dd, $J = 7.5, 1.8$ Hz, 2 × CH_{Ar}), 7.35 (2H, dd, $J = 7.5, 7.2$ Hz, 2 × CH_{Ar}), 7.30 (1H, dd, $J = 7.2, 1.8$ Hz, CH_{Ar}), 4.26 (1H, d, $J_{HP} = 17.3$ Hz, CH), 4.09–4.02 (2H, m, 1 × CH₂), 4.02–3.94 (1H, m, CH(H)), 3.92–3.82 (1H, m, CH(H)), 1.76 (1H, br, NH₂), 1.28 (3H, t, $J = 7.1$ Hz, 1 × CH₃), 1.18 (3H, t, $J = 7.1$ Hz, 1 × CH₃); δ_C (100 MHz; CDCl₃) 137.9 (ArC_{quat}), 128.6 (d, $J_{CP} = 2.2$ Hz, ArC), 128.0 (d, $J_{CP} = 2.9$ Hz, ArC), 127.9 (d, $J_{CP} = 6.3$ Hz, ArC), 64.0 (d, $J_{CP} = 7.2$ Hz, 1 × CH₂), 62.8 (d, $J_{CP} = 7.4$ Hz, 1 × CH₂), 54.3 (d, $J_{CP} = 150.3$ Hz, CH), 16.6 (d, $J_{CP} = 5.7$ Hz, 1 × CH₃), 16.5 (d, $J_{CP} = 5.6$ Hz, 1 × CH₃); δ_P (231 MHz; CDCl₃) 24.86.

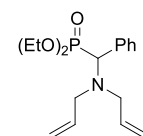
Diethyl ((diallylamino)(phenyl)methyl)phosphonate **80**

79 (0.243 g, 1.00 mmol) was added to allyl bromide (0.087 mL, 0.122 g, 1.01 mmol) and the reaction mixture was stirred at 70 °C for 24 h. The reaction mixture was loaded directly on SiO₂ and purified by flash column chromatography (SiO₂, 10% EtOAc in petrol) to give

the title compound as a yellow oil (0.133 g, 0.412 mmol, 41%). Data corresponded to that reported in the literature;¹⁶¹ $\nu_{\max}/\text{cm}^{-1}$ 3301m (N–H), 2981m, 2930w, 1722w, 1644m (N–H), 1496m, 1393m, 1244s (P=O), 1165m (C–N), 1099m, 1026s (P–O), 961s; δ_{H} (400 MHz; CDCl_3) 7.47–7.45 (2H, m, $2 \times \text{CH}_{\text{Ar}}$), 7.37–7.31 (3H, m, $3 \times \text{CH}_{\text{Ar}}$), 5.87–5.77 (2H, m, $1 \times \text{CH}_2\text{CHCH}_2$), 5.21–5.14 (4 H, m, $2 \times \text{CH}_2\text{CHCH}_2$), 4.31–4.22 (3H, m, $1 \times \text{OCH}_2\text{CH}_3$ and $(\text{EtO})_2\text{P}(\text{O})\text{CH}$), 3.97–3.77 (2H, m, OCH_2CH_3), 3.76–3.71 (2H, m, $1 \times \text{NCH}_2$), 2.75 (2H, dd, $J = 14.2, 8.1$ Hz, $1 \times \text{NCH}_2$), 1.36 (3H, dt, $J_{\text{HH}} = 7.1, J_{\text{HP}} = 0.2$ Hz, $1 \times \text{CH}_3$), 1.04 (3H, t, $J = 7.1$ Hz, $1 \times \text{CH}_3$); δ_{C} (100 MHz; CDCl_3) 136.6 ($\text{NCH}_2\text{CHCH}_2$), 132.3 (d, $J_{\text{CP}} = 5.6$ Hz, ArC), 130.9 (d, $J_{\text{CP}} = 8.9$ Hz, ArC), 128.3 (ArC), 128.0 (ArC), 117.7 ($\text{NCH}_2\text{CHCH}_2$), 63.4 (d, $J_{\text{CP}} = 6.9$ Hz, $1 \times \text{OCH}_2\text{CH}_3$), 62.2 (d, $J_{\text{CP}} = 6.9$ Hz, $1 \times \text{OCH}_2\text{CH}_3$), 60.8 (d, $J_{\text{CP}} = 164.0$ Hz, $(\text{EtO})_2\text{P}(\text{O})\text{CH}$), 54.3 (d, $J_{\text{CP}} = 8.1$ Hz, $2 \times \text{NCH}_2$), 16.8 (d, $J_{\text{CP}} = 6.1$ Hz, $1 \times \text{CH}_3$), 16.3 (d, $J_{\text{CP}} = 5.8$ Hz, $1 \times \text{CH}_3$); δ_{P} (231 MHz; CDCl_3) 23.51.

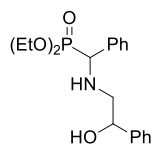
Diethyl (((2-hydroxy-2-phenylethyl)amino)(phenyl)methyl)phosphonate 81



Prepared according to the literature procedure⁹³ to give the title compound as a yellow oil and a 1.00:0.86 mixture of diastereomers (0.182 g, 0.501 mmol 65%); $\nu_{\max}/\text{cm}^{-1}$ 3336m (N–H, O–H), 2984m, 2909w, 1604w (N–H), 1495m, 1370m, 1228s (P=O), 1164m (C–N), 1099m, 1022s (P–O), 967s; δ_{H} (400 MHz; CDCl_3) 7.34–7.16 (20H, m, $20 \times \text{CH}_{\text{Ar}}$), 4.70 (1H, dd, $J = 9.0, 3.7$ Hz, OHCHPh), 4.61 (1H, dd, $J = 8.7, 3.6$ Hz, OHCHPh), 4.08–3.55 (12H, m, $4 \times \text{CH}_3\text{CH}_2\text{O}$ and $2 \times (\text{EtO})_2\text{P}(\text{O})\text{CH}$ and $2 \times \text{OH}$), 2.84 (1H, dd, $J = 12.3, 3.6$ Hz, $1 \times \text{NHCH}(\text{H})$), 2.72 (1H, dd, $J = 12.4, 3.7$ Hz, $1 \times \text{NHCH}(\text{H})$), 2.64 (1H, dd, $J = 12.4, 9.0$ Hz, $1 \times \text{NHCH}(\text{H})$), 2.55 (1H, dd, $J = 12.3, 8.7$ Hz, $1 \times \text{NHCH}(\text{H})$), 2.84–2.55 (2H, br, $2 \times \text{NH}$), 1.24 (3H, t, $J = 7.1$ Hz, $1 \times \text{CH}_3$), 1.23 (3H, t, $J = 7.1$ Hz, $1 \times \text{CH}_3$), 1.08–1.00 (6H, m, $2 \times \text{CH}_3$); δ_{C} (100 MHz; CDCl_3) 142.4 (ArC_{quat}), 142.2 (ArC_{quat}), 136.0 (d, $J_{\text{CP}} = 2.9$ Hz, ArC_{quat}), 135.6 (d, $J_{\text{CP}} = 2.8$ Hz, ArC_{quat}), 128.9 (d, $J_{\text{CP}} = 6.4$ Hz, ArCH), 128.7–128.4 (m, ArCH), 128.2 (d, $J_{\text{CP}} = 2.8$ Hz, ArCH), 128.1 (d, $J_{\text{CP}} = 2.7$ Hz, ArCH), 127.9 (d, $J_{\text{CP}} = 2.57$ Hz, ArCH), 127.6 (d, $J_{\text{CP}} = 1.3$ Hz, ArCH), 125.9 (ArCH), 72.8 (OHCHPh), 71.6 (OHCHPh), 63.1–62.8 ($4 \times \text{CH}_2\text{CH}_3$), 61.5 (d, $J_{\text{CP}} = 153.8$

Hz, CHP(O)(OEt)_2), 60.1 (d, $J_{\text{CP}} = 154.1$ Hz, CHP(O)(OEt)_2), 56.2 (d, $J_{\text{CP}} = 15.4$ Hz, NHCH_2), 55.1 (d, $J_{\text{CP}} = 15.4$ Hz, NHCH_2), 16.6 (d, $J_{\text{CP}} = 5.5$ Hz, $2 \times \text{CH}_3$), 16.34 (d, $J_{\text{CP}} = 5.8$ Hz, $1 \times \text{CH}_3$), 16.32 (d, $J_{\text{CP}} = 5.7$ Hz, $1 \times \text{CH}_3$); δ_{P} (231 MHz; CDCl_3) 23.38, 23.27.

Experimental data for Chapter 4

General procedure E for the synthesis of esters

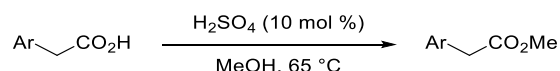

To the appropriate arylacetic acid in MeOH (1.00 mL mmol⁻¹) was added H₂SO₄ (99%, 0.100 equiv.) and the resulting solution was stirred at 70 °C for 16 h. After cooling, the MeOH was then removed *in vacuo* and the residue was redissolved in water, basified (15% aq. NaOH) to pH 12–14 and washed three times with ether. The combined organics were dried (MgSO₄), filtered and concentrated *in vacuo* to yield the ester. If necessary, this was further purified by column chromatography (SiO₂, 10% Et₂O in petrol) to give the pure product.

Methyl 2-(2-nitrophenyl)acetate 93a

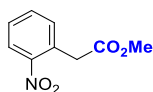

Prepared according to General Procedure E from 2-(nitrophenyl)acetic acid (3.62 g, 20.0 mmol) and H₂SO₄ (0.10 mL, 2.00 mmol) in MeOH (20 mL) to give the title compound as white crystals (3.86 g, 19.8 mmol, 99%). Data corresponded to that reported in the literature;¹⁶² mp 51–53 °C (from PhMe); $\nu_{\text{max}}/\text{cm}^{-1}$ 2954w, 2360s, 2342s, 1736s (C=O), 1523s (NO₂), 1435m, 1414m, 1345s (NO₂), 1219s (C–O), 1168s (C–O), 1078m, 1000m; δ_{H} (400 MHz; CDCl₃) 8.03 (1H, dd, *J* = 8.2, 1.1 Hz, CH_{Ar}), 7.57–7.53 (1H, m, CH_{Ar}), 7.44–7.40 (1H, m, CH_{Ar}), 7.32 (1H, d, *J* = 7.6 Hz, CH_{Ar}), 3.98 (2H, s, CH₂), 3.64 (3H, s, CH₃); δ_{C} (100 MHz; CDCl₃) 170.3 (CO₂Me), 148.6 (CNO₂), 133.6 (ArCH), 133.3 (ArCH), 129.6 (ArC_{quat}), 128.6 (ArCH), 125.1 (ArCH), 52.1 (CH₃), 39.4 (CH₂).

Methyl 2-(4-nitrophenyl)acetate 93b

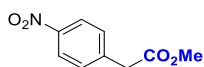

Prepared according to General Procedure E from 4-(nitrophenyl)acetic acid (3.62 g, 20.0 mmol) and H₂SO₄ (0.10 mL, 2.00 mmol) in MeOH (20 mL) to give the title compound as white crystals (3.78 g, 19.4 mmol, 97%). Data corresponded to that reported in the

literature;¹⁶³ mp 52–55 °C (from PhMe; lit.¹⁶³ 46–48 °C); $\nu_{\max}/\text{cm}^{-1}$ 2956w, 1732s (C=O), 1510s (NO₂), 1434m, 1413m, 1345s (NO₂), 1220s (C–O), 1164s (C–O), 1110m, 995m; δ_{H} (400 MHz; CDCl₃) 8.16 (2H, d, J = 8.8 Hz, 2 × CH_{Ar}), 7.44 (2H, d, J = 8.8 Hz, 2 × CH_{Ar}), 3.73 (2H, s, CH₂), 3.70 (3H, s, CH₃); δ_{C} (100 MHz; CDCl₃) 170.7 (CO₂Me), 147.3 (CNO₂), 141.4 (ArC_{quat}), 130.4 (ArCH), 123.8 (ArCH), 52.4 (CH₃), 40.8 (CH₂).

Methyl 2-(2,4-dinitrophenyl)acetate 93c

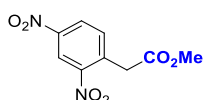

Prepared according to General Procedure E from 2,4-(dinitrophenyl)acetic acid (11.3 g, 50.0 mmol) and H₂SO₄ (0.25 mL, 5.00 mmol) in MeOH (50 mL) to give the *title compound* as yellow crystals (11.52 g, 48.0 mmol, 96%); mp 81–83 °C (from PhMe); $\nu_{\max}/\text{cm}^{-1}$ 3070m, 1735s (C=O), 1603m, 1545s (N–O), 1530s (N–O), 1444m, 1417m, 1341s (NO₂), 1221s (C–O), 1171s (C–O), 1072m, 987m; δ_{H} (400 MHz; CDCl₃) 8.87 (1H, dd, J = 2.4 Hz, CH_{Ar}), 8.41 (1H, d, J = 8.4, 2.4 Hz, CH_{Ar}), 7.63 (1H, d, J = 8.4 Hz, CH_{Ar}), 4.13 (2H, s, CH₂), 3.69 (3H, s, CH₃); δ_{C} (100 MHz; CDCl₃) 169.2 (CO₂Me), 148.9 (CNO₂), 147.4 (CNO₂), 136.4 (ArC_{quat}), 134.8 (ArCH), 127.5 (ArCH), 120.7 (ArCH), 52.6 (CH₃), 39.3 (CH₂); m/z (APCI+, (M + H)⁺, 100%) Found: 241.0453 C₉H₉O₆N₂ requires: 241.0455.

Methyl 2-(4-fluoro-6-nitrophenyl)acetate 93f

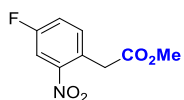

Prepared according to General Procedure E from 2-(4-fluoro-6-nitrophenyl)acetic acid¹⁶⁴ (3.98 g, 20.0 mmol) and H₂SO₄ (0.10 mL, 2.00 mmol) in MeOH (20 mL) to give the *title compound* as a yellow oil (3.60 g, 16.9 mmol, 85%); $\nu_{\max}/\text{cm}^{-1}$ 3090w, 2958w, 1719s (C=O), 1683w, 1529s (N–O), 1459m, 1440m, 1427m, 1339s (N–O), 1237s (C–O), 1210s (C–O), 1165s, 1142s, 999s; δ_{H} (400 MHz; CDCl₃) 7.83 (1H, d, J_{HH} = 2.5 Hz, J_{HF} = 8.4 Hz, CH_{Ar}), 7.37–7.29 (2H, m, 2 × CH_{Ar}), 3.99 (2H, s, CH₂), 3.70 (3H, s, CH₃); δ_{C} (100 MHz; CDCl₃) 170.3 (CO₂Me), 161.6 (d, J_{CF} = 251.4 Hz, CF), 149.3 (d, J_{CF} = 7.9 Hz, CNO₂), 134.9 (d, J_{CF} = 7.9 Hz, ArCH), 125.9 (d, J_{CF} = 3.7 Hz, ArC_{quat}), 120.9 (d, J_{CF} = 20.9 Hz, ArCH), 113.0 (d, J_{CF} = 26.4 Hz, ArCH), 52.4 (CH₃), 39.0 (CH₂); δ_{F} (376 MHz; CDCl₃) –110.7

(dd, $J_{\text{HF}} = 7.5, 13.5$ Hz); m/z (APCI+, (M + H)⁺, 100%) Found: 214.0509
C₉H₉O₄NF requires: 214.0510.

Methyl 2-(3-fluoro-6-nitrophenyl)acetate 93g

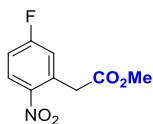

Prepared according to General Procedure E from 2-(3-fluoro-6-nitrophenyl)acetic acid¹⁶⁵ (3.98 g, 20.0 mmol) and H₂SO₄ (0.10 mL, 2.00 mmol) in MeOH (20 mL) to give the *title compound* as a yellow oil (3.84 g, 18.0 mmol, 90%); $\nu_{\text{max}}/\text{cm}^{-1}$ 2923w, 1737s (C=O), 1624m, 1591s (C-F), 1525s (N-O), 1485m, 1435m, 1343s (N-O), 1252s (C-O), 1207s (C-O), 1078m, 962m; δ_{H} (400 MHz; CDCl₃) 8.20 (1H, dd, $J_{\text{HH}} = 9.1$ Hz, $J_{\text{HF}} = 5.2$ Hz, CH_{Ar}), 7.15 (1H, ddd, $J_{\text{HH}} = 9.1, 2.7$ Hz, $J_{\text{HF}} = 7.2$ Hz, CH_{Ar}), 7.07 (1H, dd, $J_{\text{HH}} = 8.6$ Hz, $J_{\text{HF}} = 2.7$ Hz, CH_{Ar}), 4.02 (2H, s, CH₂), 3.72 (3H, s, CH₃); δ_{C} (100 MHz; CDCl₃) 169.9 (CO₂Me), 164.9 (d, $J_{\text{CF}} = 257.8$ Hz, CF), 145.0 (d, $J_{\text{CF}} = 2.7$ Hz, CNO₂), 133.4 (d, $J_{\text{CF}} = 9.4$ Hz, ArC_{quat}), 128.4 (d, $J_{\text{CF}} = 10.0$ Hz, ArCH), 120.4 (d, $J_{\text{CF}} = 23.7$ Hz, ArCH), 115.7 (d, $J_{\text{CF}} = 22.8$ Hz, ArCH), 52.5 (CH₃), 39.8 (CH₂); δ_{F} (376 MHz; CDCl₃) -103.29; m/z (APCI+, (M + H)⁺, 100%) Found: 214.0509 C₉H₉O₄NF requires: 214.0510.

Methyl 2-(2-methoxyphenyl)acetate 93h

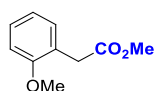

Prepared according to General Procedure E from 2-(methoxyphenyl)acetic acid (25.0 g, 151 mmol) and H₂SO₄ (0.75 mL, 15.0 mmol) in MeOH (150 mL) to give the *title compound* as a colourless oil (25.9 g, 144.0 mmol, 95%). Data corresponded to that reported in the literature;¹⁶⁶ $\nu_{\text{max}}/\text{cm}^{-1}$ 2952w, 1735s (C=O), 1603m, 1590m, 1542m, 1463m, 1437m, 1323m, 1245s (C-O), 1220s (C-O), 1179s (C-O), 1155m, 1050m, 1028m; δ_{H} (400 MHz; CDCl₃) 7.27–7.17 (1H, m, CH_{Ar}), 7.18 (1H, dd, $J = 7.4, 1.3$ Hz, CH_{Ar}), 6.93–6.85 (1H, m, CH_{Ar}), 6.86 (1H, d, $J = 8.3$ Hz, CH_{Ar}), 3.78 (3H, s, OCH₃), 3.66 (3H, s, CO₂CH₂CH₃), 3.64 (2H, s, CH₂); δ_{C} (100 MHz; CDCl₃) 172.1 (CO₂Me), 157.4 (ArC_{quat}), 130.7 (ArCH), 128.4 (ArCH), 122.9 (ArC_{quat}), 120.2 (ArCH), 110.3 (ArCH), 55.2 (PhOCH₃) 51.6 (CO₂CH₂CH₃), 35.5 (CH₂).

General procedure F for synthesis of cyclopropanecarboxylates:

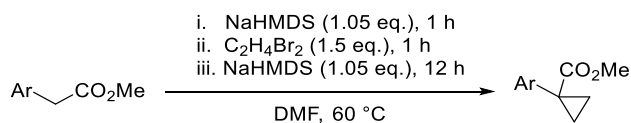

To the appropriate methyl arylacetate (1.0 equiv.) in DMF (0.5 mL/mmol), was added NaHMDS (2.0 M in THF, 1.05 equiv.) dropwise under an argon atmosphere and the mixture was stirred at 60 °C for 1 h and then allowed to cool down to room temperature. To the mixture was added dibromoethane (1.5 equiv.) and the mixture was again stirred at 60 °C for 1 h. After cooling to room temperature, NaHMDS (2.0 M in THF, 1.05 equiv.) was added and the reaction was stirred at 60 °C for 12 h. The reaction mixture was washed with brine and extracted three times with EtOAc. The combined organic layers were dried (MgSO_4), filtered and concentrated *in vacuo*. The crude product was purified by flash column chromatography (SiO_2) to yield the cyclopropane.

Methyl 1-(2-Nitrophenyl)cyclopropanecarboxylate **94a**

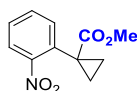

Prepared according to General Procedure F from **93a** (2.15 g, 11.0 mmol), NaHMDS (2 × 5.80 mL, 11.6 mmol) and dibromoethane (1.43 mL, 16.5 mmol) in DMF (5.5 mL) and purified by flash column chromatography (10% Et₂O in petrol) to give the *title compound* as a yellow oil (0.801 g, 3.62 mmol, 33%); $\nu_{\text{max}}/\text{cm}^{-1}$ 1674s (C=O), 1525s (N–O), 1422m, 1339s (N–O), 1213m, 1214s (C–O), 1110s, 1061s; δ_{H} (400 MHz; CDCl_3) 7.99 (1H, dd, $J = 8.1, 1.0$ Hz, CH_{Ar}), 7.58 (1H, ddd, $J = 7.7, 7.4, 1.0$ Hz, CH_{Ar}), 7.49 (1H, dd, $J = 7.7, 1.3$ Hz, CH_{Ar}), 7.45 (1H, ddd, $J = 8.1, 7.4, 1.3$ Hz, CH_{Ar}), 3.62 (3H, s, CH_3), 1.74–1.73 (2H, m, 2 × $\text{CH}(\text{H})$), 1.16–1.14 (2H, m, 2 × $\text{CH}(\text{H})$); δ_{C} (100 MHz; CDCl_3) 173.5 (CO_2Me), 150.5 (CNO_2), 134.9 (ArC_{quat}), 133.2 (ArCH), 133.1 (ArCH), 128.6 (ArCH), 124.9 (ArCH), 27.7 (CCO_2Me), 17.3 (2 × CH_2); m/z (APCI+, $(\text{M} + \text{H})^+$, 100%) Found: 222.0761 $\text{C}_{11}\text{H}_{12}\text{O}_4\text{N}$ requires: 222.0762.

Methyl 1-(4-Nitrophenyl)cyclopropanecarboxylate **94b**

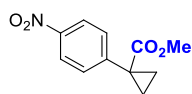

Prepared according to General Procedure F from **93b** (2.15 g, 11.0 mmol), NaHMDS (2 × 5.80 mL, 11.6 mmol) and dibromoethane (1.43 mL, 16.5 mmol) in DMF (5.5 mL) and purified by flash column chromatography (10% Et₂O in petrol) to give the title compound as a yellow oil (0.750 g, 3.39 mmol, 31%). Data corresponded to that reported in the literature;¹⁶⁷ $\nu_{\max}/\text{cm}^{-1}$ 1680s (C=O), 1601s, 1514s (N–O), 1438s, 1421s, 1335s (N–O), 1283s (C–O), 1112m, 1092s; δ_{H} (400 MHz; CDCl₃) 8.17 (2H, d, $J = 8.7$ Hz, 2 × CH_{Ar}), 7.52 (2H, d, $J = 8.7$ Hz, 2 × CH_{Ar}), 3.64 (3H, s, CH₃), 1.71 (2H, dd, $J = 7.2, 4.3$ Hz, 2 × CH(H)), 1.24 (2H, dd, $J = 7.2, 4.3$ Hz, 2 × CH(H)); δ_{C} (100 MHz; CDCl₃) 173.8 (CO₂Me), 147.2 (CNO₂), 147.0 (ArC_{quat}), 131.6 (ArCH), 123.6 (ArCH), 52.7 (CH₃), 29.0 (CCO₂H), 17.0 (2 × CH₂).

Methyl 1-(2,4-Dinitrophenyl)cyclopropanecarboxylate **94c**

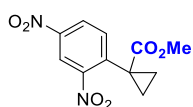

Prepared according to General Procedure F with **93c** (11.5 g, 47.9 mmol), NaHMDS (2 × 25.1 mL, 50.3 mmol) and dibromoethane (6.20 mL, 71.9 mmol) in DMF (24 mL) and purified by flash column chromatography (15% Et₂O in petrol) to give the *title compound* as a yellow oil (4.53 g, 17.0 mmol, 35%); $\nu_{\max}/\text{cm}^{-1}$ 1700s (C=O), 1535s (N–O), 1421m, 1340s (N–O), 1298s (C–O), 1210m, 1150m, 1058m; δ_{H} (400 MHz; CDCl₃) 8.86 (1H, d, $J = 2.4$ Hz, CH_{Ar}), 8.43 (1H, dd, $J = 2.4, 8.5$ Hz, CH_{Ar}), 7.72 (1H, d, $J = 8.5$ Hz, CH_{Ar}), 3.64 (3H, s, CH₃), 1.85–1.84 (2H, m, 2 × CH(H)), 1.24–1.21 (2H, m, 2 × CH(H)); δ_{C} (100 MHz; CDCl₃) 177.2 (CO₂H), 147.3 (CNO₂), 141.5 (CNO₂), 138.4 (ArC_{quat}), 134.4 (ArCH), 127.3 (ArCH), 120.6 (ArCH), 53.0 (CH₃), 27.8 (CCO₂Me), 17.7 (2 × CH₂).

Methyl 1-(4-Fluoro-6-nitrophenyl)cyclopropanecarboxylate **94f**

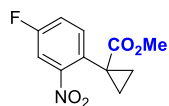

Prepared according to General Procedure F with **93f** (4.50 g, 21.1 mmol), NaHMDS (2 × 11.1 mL, 22.2 mmol) and dibromoethane (2.73 mL, 31.7 mmol) in DMF (10.5 mL) and

purified by flash column chromatography (10% Et₂O in petrol) to give the *title compound* as a yellow oil (0.951 g, 3.98 mmol, 19%); $\nu_{\max}/\text{cm}^{-1}$ 2954w, 1730s (C=O), 1527s (N–O), 1432m, 1347s (N–O), 1305s (C–F) 1270s (C–O), 1198m, 1139m, 1056m; δ_{H} (400 MHz; CDCl₃) 7.73 (1H, dd, $J_{\text{HH}} = 2.7$ Hz, $J_{\text{HF}} = 8.3$ Hz, CH_{Ar}), 7.49 (1H, dd, $J_{\text{HH}} = 8.6$ Hz, $J_{\text{HF}} = 5.5$ Hz, CH_{Ar}), 7.30 (1H, ddd, $J_{\text{HH}} = 8.6$, 2.7 Hz, $J_{\text{HF}} = 7.5$ Hz, CH_{Ar}), 3.62 (3H, s, CH₃), 1.74–1.74 (2H, m, 2 × CH(H)), 1.13 (2H, br, 2 × CH(H)); δ_{C} (100 MHz; CDCl₃) 173.3 (CO₂Me), 161.3 (d, $J_{\text{CF}} = 251.5$ Hz, CF), 150.8 (d, $J_{\text{CF}} = 8.4$ Hz, CNO₂), 134.7 (d, $J_{\text{CF}} = 7.9$ Hz, ArCH), 131.0 (d, $J_{\text{CF}} = 3.8$ Hz, ArC_{quat}), 120.4 (d, $J_{\text{CF}} = 21.1$ Hz, ArCH), 112.6 (d, $J_{\text{CF}} = 26.7$ Hz, ArCH), 52.7 (CH₃), 27.2 (CCO₂Me), 17.4 (2 × CH₂); δ_{F} (376 MHz; CDCl₃) –110.51 (dt, $J_{\text{HF}} = 5.6$, 7.7 Hz); m/z (APCI+, (M + H)⁺, 100%) Found: 240.0665 C₁₁H₁₁O₄NF requires: 240.0667.

Methyl 1-(3-fluoro-6-nitrophenyl)cyclopropanecarboxylate **94g**

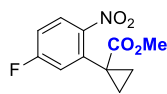

Prepared according to General Procedure F with **93g** (3.2 g, 15.0 mmol), NaHMDS (2 × 7.88 mL, 15.8 mmol) and dibromoethane (1.94 mL, 22.5 mmol) in DMF (7.5 mL) and purified by flash column chromatography (10% Et₂O in petrol) to give the *title compound* as a yellow oil (2.40 g, 10.0 mmol, 67%); $\nu_{\max}/\text{cm}^{-1}$ 1690s (C=O), 1515s (N–O), 1421m, 1305s (N–O), 1220s (C–O), 1205m, 1167m, 1098m, 1061m; δ_{H} (400 MHz; CDCl₃) 7.73 (1H, d, $J_{\text{HH}} = 2.7$ Hz, $J_{\text{HF}} = 8.2$ Hz, CH_{Ar}), 7.49 (1H, d, $J_{\text{HH}} = 8.6$ Hz, $J_{\text{HF}} = 5.4$ Hz, CH_{Ar}), 7.30 (2H, dd, $J_{\text{HH}} = 8.6$, 2.7 Hz, $J_{\text{HF}} = 7.4$ Hz, CH_{Ar}), 3.63 (3H, s, CH₃), 1.75–1.74 (2H, m, 2 × CH(H)), 1.14–1.13 (2H, m, 2 × CH(H)); δ_{C} (100 MHz; CDCl₃) 173.3 (CO₂Me), 160.9 (d, $J_{\text{CF}} = 251.5$ Hz, CF), 150.5 (d, $J_{\text{CF}} = 8.5$ Hz, CNO₂), 134.7 (d, $J_{\text{CF}} = 8.0$ Hz, ArCH), 131.0, (d, $J_{\text{CF}} = 3.8$ Hz, ArC_{quat}), 130.4 (d, $J_{\text{CF}} = 21.1$, ArCH), 112.6 (d, $J_{\text{CF}} = 26.5$, ArCH), 52.7 (CH₃), 27.2 (CCO₂Me), 17.4 (2 × CH₂); δ_{F} (376 MHz; CDCl₃) –110.49 (dt, $J = 5.6$, 7.7 Hz); m/z (APCI+, (M + H)⁺, 100%) 240.0667 Found: C₁₁H₁₁O₅NF requires: 240.0669.

Methyl 1-(2-Methoxyphenyl)cyclopropanecarboxylate **94h**

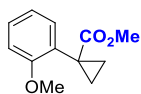

Prepared according to General Procedure F with **93h** (0.900 g, 5.00 mmol), NaHMDS (2×5.25 mL, 10.1 mmol) and dibromoethane (0.645 mL, 7.50 mmol) in DMF (2.50 mL) and purified by flash column chromatography (10% Et₂O in petrol) to give the *title compound* as a colourless oil (0.302 g, 1.47 mmol, 29%); $\nu_{\max}/\text{cm}^{-1}$ 1685s (C=O), 1601s, 1575m, 1410s (C–O), 1309m, 1111s (OMe), 1090m; δ_{H} (400 MHz; CDCl₃) 7.27 (1H, ddd, $J = 8.2, 7.5, 1.7$ Hz, CO₂H), 7.21 (1H, dd, $J = 7.5, 1.7$ Hz, CH_{Ar}), 6.91 (1H, ddd, $J = 7.5, 7.5, 1.0$ Hz, CH_{Ar}), 6.88 (1H, dd, $J = 8.2, 1.0$ Hz, CH_{Ar}), 3.84 (3H, s, OCH₃), 3.61 (3H, s, CO₂CH₃), 1.61 (2H, dd, $J = 7.2, 4.1$ Hz, $2 \times \text{CH}(\text{H})$), 1.12 (2H, dd, $J = 7.2, 4.1$ Hz, $2 \times \text{CH}(\text{H})$); δ_{C} (100 MHz; CDCl₃) 175.3 (CO₂Me), 159.3 (COMe), 130.4 (ArCH), 128.7 (ArCH), 128.4 (ArC_{quat}), 120.3 (ArCH), 110.7 (ArCH), 55.6 (OCH₃), 52.3 (CO₂CH₃), 25.1 (CCO₂Me), 16.7 ($2 \times \text{CH}_2$); m/z (APCI+, (M + H)⁺, 100%) Found: 207.1015 C₁₂H₁₅O₃ requires: 207.1016.

Ethyl 1-(Benzothiazol-2-yl)cyclopropanecarboxylate **94i**

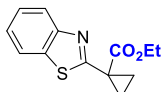

Prepared according to General Procedure F with ethyl (benzothiazol-2-yl)acetate¹⁶⁸ (**93i**) (8.69 g, 39.3 mmol), NaHMDS (2×20.6 mL, 41.3 mmol) and dibromoethane (5.08 mL, 59.0 mmol) in DMF (20 mL) and purified by flash column chromatography (5% Et₂O in petrol) to give the *title compound* as a yellow oil (6.98 g, 28.3 mmol, 72%); $\nu_{\max}/\text{cm}^{-1}$ 2572m (C–N), 1686s (C=O), 1498m, 1407m, 1320s, 1200s (C–O), 1055m, 911m, 758s (C–S); δ_{H} (400 MHz; CDCl₃) 7.90 (1H, d, $J = 8.1$ Hz, CH_{Ar}), 7.86–7.84 (1H, m, CH_{Ar}), 7.44–7.40 (1H, m, CH_{Ar}), 7.35–7.31 (1H, m, CH_{Ar}), 4.27 (2H, q, $J = 7.1$ Hz, CH₂CH₃), 1.97–1.90 (4H, m, $4 \times \text{CH}(\text{H})_{\text{cpr}}$), 1.31 (3H, $J = 7.1$ Hz, CH₃); δ_{C} (100 MHz; CDCl₃) 172.0 (CO₂Et), 168.9 (ArC_{quat}), 152.0 (ArC_{quat}), 136.1 (ArC_{quat}), 126.8 (ArCH), 124.6 (ArCH), 122.6 (ArCH), 121.3 (ArCH), 61.7 (CH₂CH₃), 28.0 (CCO₂Et), 22.9 ($2 \times \text{cprCH}_2$), 14.3 (CH₃); m/z (APCI+, (M – H)⁺, 100%) Found: 248.0739 C₁₃H₁₂O₂NS requires: 248.0740.

Methyl 1-(Benzoxazol-2-yl)cyclopropanecarboxylate **94m**

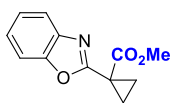

Prepared according to General Procedure F with methyl (benzoxazol-2-yl)acetate¹⁶⁹ (**93m**) (1.22 g, 6.39 mmol), NaHMDS (2 × 3.35 mL, 13.4 mmol) and dibromoethane (0.825 mL, 9.60 mmol) in DMF (3.4 mL) and purified by flash column chromatography (10% Et₂O in petrol) to give the *title compound* as a yellow oil (0.381 g, 1.76 mmol, 28%); $\nu_{\max}/\text{cm}^{-1}$ 2854m (C–N), 1735s (C=O), 1555m, 1423s (C–O), 1320s, 1203m, 1158s, 1111m, 1010m; δ_{H} (400 MHz; CDCl₃) 7.70–7.66 (1H, m, CH_{Ar}), 7.53–7.48 (1H, m, CH_{Ar}), 7.35–7.29 (2H, m, 2 × CH_{Ar}), 3.74 (3H, s, CH₃), 1.79–1.76 (2H, m, 2 × CH(H)), 1.67–1.64 (2H, m, 2 × CH(H)); δ_{C} (100 MHz; CDCl₃) 171.3 (CO₂Me), 163.9 (ArC_{quat}), 151.2 (ArC_{quat}), 141.0 (ArC_{quat}), 125.2 (ArCH), 124.4 (ArCH), 120.1 (ArCH), 110.7 (ArCH), 52.9 (CH₃), 23.4 (CCO₂Me), 17.6 (2 × CH₂); m/z (APCI+, (M + H)⁺, 100%) Found: 218.0810 C₁₂H₁₂O₃N requires: 218.0812.

Methyl 1-(Quinolin-2-yl)cyclopropanecarboxylate **94n**

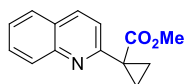

Prepared according to General Procedure F with methyl (quinolin-2-yl)acetate¹⁷⁰ (**93n**) (2.29 g, 11.4 mmol), NaHMDS (2 × 6.00 mL, 24.0 mmol) and dibromoethane (1.47 mL, 17.1 mmol) in DMF (5.7 mL) and purified by flash column chromatography (10% Et₂O in petrol) to give the *title compound* as a yellow oil (0.969 g, 4.27 mmol, 37%) that was used directly in the next step; IR $\nu_{\max}/\text{cm}^{-1}$ 2298m (C–N), 1690s (C=O), 1521s, 1425s (C–O), 1350m, 1304m, 1219m, 1145m, 1011m; δ_{H} (400 MHz; CDCl₃) 8.09 (1H, d, $J = 8.5$ Hz, CH_{Ar}), 8.05 (1H, d, $J = 8.4$ Hz, CH_{Ar}), 7.79 (1H, d, $J = 7.9$ Hz, CH_{Ar}), 7.70–7.66 (1H, m, CH_{Ar}), 7.58 (1H, d, $J = 8.5$ Hz, CH_{Ar}), 7.53–7.49 (1H, m, CH_{Ar}), 3.68 (3H, s, CH₃), 1.75–1.72 (2H, m, 2 × CH(H)), 1.64–1.61 (2H, m, 2 × CH(H)).

General procedure G for synthesis of cyclopropanecarbonitriles:

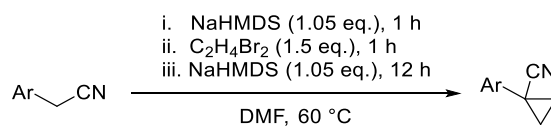

To the appropriate arylacetonitrile (1.00 equiv.) in DMF (0.50 mL mmol⁻¹), was added NaHMDS (2.0 M in THF, 2.10 equiv.) dropwise under an argon atmosphere and the mixture was stirred at 60 °C for 1 h and then allowed to cool down to room temperature. To the cooled mixture was added dibromoethane (2.0 equiv.) and the mixture was again stirred at 60 °C for 1 h. After cooling to room temperature, NaHMDS (2.0 M in THF, 1.05 equiv.) was added and the reaction was stirred at 60 °C overnight. To the resulting mixture was added dibromoethane (1.50 equiv.) and the mixture was stirred overnight at 60 °C. The reaction mixture was washed with brine and extracted three times in ethyl acetate. The combined organic layers were dried (MgSO₄), filtered and concentrated *in vacuo*. The crude product was purified by flash column chromatography to yield the cyclopropane.

1-(3-Nitrophenyl)cyclopropanecarbonitrile **94d**

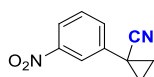

Prepared according to General Procedure G from 2-(3-nitrophenyl)acetonitrile (**93d**) (1.00 g, 6.17 mmol), NaHMDS (2 × 3.24 mL, 13.0 mmol) and dibromoethane (0.795 mL, 9.26 mmol) in DMF (3.1 mL) and purified by flash column chromatography (10% Et₂O in petrol) to give the *title compound* as a yellow oil (0.696 g, 3.70 mmol, 60%) that was used directly in the next step; $\nu_{\text{max}}/\text{cm}^{-1}$ 2225 (CN), 1650s (C=O), 1523s (N–O), 1419m, 1341s (N–O), 1298m, 1172m, 1110s, 1069s; δ_{H} (400 MHz; CDCl₃) 8.16 (1H, ddd, $J = 8.2, 2.0, 0.9$ Hz, CH_{Ar}), 8.06–8.06 (1H, m, CH_{Ar}), 7.50 (1H, ddd, $J = 7.8, 1.7, 0.9$ Hz, CH_{Ar}), 7.59–7.55 (1H, m, CH_{Ar}), 1.80–1.79 (2H, m, 2 × CH(H)), 1.23–1.19 (2H, m, 2 × CH(H)).

1-(2-Fluorophenyl)cyclopropanecarbonitrile **94e**

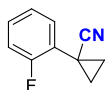

Prepared according to General Procedure G with 2-(2-fluorophenyl)acetonitrile (**93e**) (6.37 mL, 6.75 g, 50.0 mmol), NaHMDS (2 × 52.5 mL, 101 mmol) and dibromoethane (6.45 mL, 75.0 mmol) in DMF (25 mL) and purified by flash column chromatography (5% Et₂O in petrol) to give the *title compound* as a yellow oil (7.02 g, 43.6 mmol, 87%); $\nu_{\max}/\text{cm}^{-1}$ 3033w, 2236s (C≡N), 1683s (C=O), 1494s, 1451m, 1220s (C–F), 1122m, 1076m; δ_{H} (400 MHz; CDCl₃) 7.35–7.30 (2H, m, 2 × CH_{Ar}), 7.15–7.06 (2H, m, 2 × CH_{Ar}), 1.70–1.67 (2H, m, 2 × CH(H)), 1.41–1.38 (2H, m, 2 × CH(H)); δ_{C} (100 MHz; CDCl₃) 161.0 (d, $J_{\text{CF}} = 250.2$ Hz, CF), 130.6–130.5 (m, 2 × ArCH), 124.5 (d, $J_{\text{CF}} = 3.7$ Hz, ArCH), 123.4 (d, $J_{\text{CF}} = 13.4$ Hz, ArC_{quat}), 122.1 (CN), 116.2 (d, $J_{\text{CF}} = 20.9$ Hz, ArCH), 15.6 (d, $J_{\text{CF}} = 1.8$ Hz, 2 × CH₂), 9.3 (CCN); δ_{F} (376 MHz; CDCl₃) –114.2; m/z (APCI+, (M + H)⁺, 100%) Found: 162.0713 C₁₀H₉NF requires: 162.0714.

Methyl 1-(2-nitrophenyl)-2-phenylcyclopropanecarboxylate **94q**

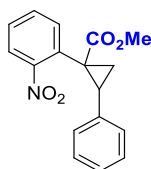

Prepared according to a modified literature procedure.¹¹⁷ To a solution of **93a** (1.95 g, 10.0 mmol) in THF (15.0 mL) was added NaHMDS (2.0 M in THF, 10.0 mL, 20.0 mmol) and the solution was allowed to stir for 1 h at 22 °C. Styrene (2.30 mL, 20.0 mmol) was added and the reaction was stirred at 22 °C for 16 h. Sat. aq. NH₄Cl (10 mL) was added and the THF was removed *in vacuo*. The aqueous layer was washed with EtOAc (3 × 15 mL), dried (MgSO₄), filtered and concentrated *in vacuo*. The crude product was then purified by flash column chromatography (5% Et₂O in petrol) to give the *title compound* as a yellow oil (1.22 g, 4.11 mmol, 41%); $\nu_{\max}/\text{cm}^{-1}$ 2955w, 1717s (C=O), 1516s (N–O), 1496s, 1347s (N–O), 1259s (C–O), 1164s, 1029m; δ_{H} (400 MHz; CDCl₃) 7.99–7.96 (2H, m, 2 × CH_{Ar}), 7.20–7.18 (2H, m, 2 × CH_{Ar}), 7.09–7.06 (3H, m, 3 × CH_{Ar}), 6.80–6.78 (2H, m, 2 × CH_{Ar}), 3.68 (3H, s, CO₂CH₃), 3.21 (1H, dd, $J = 9.3, 7.4$ Hz, CHPh), 2.24 (1H, dd, $J = 9.3, 5.3$ Hz, 1 × CH(H)), 1.96 (1H, $J = 7.4, 5.3$ Hz, 1 × CH(H)); δ_{C} (100 MHz; CDCl₃) 173.0 (CO₂Me), 147.0 (CNO₂), 142.8 (ArC_{quat}), 135.3 (ArC_{quat}), 132.9 (2 × ArCH), 128.3 (2 × ArCH), 128.1 (2 × ArCH), 127.1

(ArCH), 123.0 (2 × ArCH), 53.0 (CH₃), 37.1 (CCO₂Me), 33.7 (CHPh), 30.1 (CH₂); *m/z* (APCI+, (M + H)⁺, 100%) Found: 298.1073 C₁₇H₁₆O₄N requires: 298.1074.

General procedure H for synthesis of cyclopropanecarboxylic acids from esters:

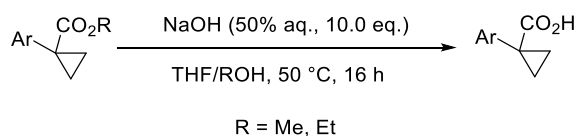

To the appropriate methyl arylcyclopropane carboxylate (1.00 equiv.) in THF/MeOH (THF/EtOH in the case of **94l**) (5.00 mL mmol⁻¹), was added NaOH (50% aq., 10.0 equiv.). The mixture was stirred for 16 h at 50 °C. The organic solvent was removed *in vacuo* and the aqueous phase was washed three times with Et₂O. The aqueous layer was then acidified (HCl, 35% aq.) to pH 3–4 and was extracted three times with Et₂O. The combined organic layers from the second washing were dried (MgSO₄), filtered and concentrated *in vacuo*. The crude product was recrystallised to yield the carboxylic acid.

1-(2-Nitrophenyl)cyclopropanecarboxylic acid **95a**

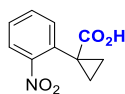

Prepared according to General Procedure H from **94a** (1.11 g, 5.02 mmol) and NaOH (50% aq., 4.0 mL, 50.2 mmol) in THF/MeOH (25 mL) and recrystallised from PhMe to give the *title compound* as white crystals (0.881 g, 4.25 mmol, 85%); mp 147–149 °C (from PhMe); $\nu_{\max}/\text{cm}^{-1}$ 2850br (O–H), 1677s (C=O), 1520s (N–O), 1423m (C–O–H), 1338s (N–O), 1308s (C–O), 1219s (C–O), 1116m, 1071m; δ_{H} (400 MHz; CDCl₃) 10.31 (1H, br, CO₂H), 8.00 (1H, dd, *J* = 8.2, 1.3 Hz, CH_{Ar}), 7.58 (1H, ddd, *J* = 7.7, 7.5, 1.3 Hz, CH_{Ar}), 7.50 (1H, dd, *J* = 7.7, 1.5 Hz, CH_{Ar}), 7.45 (1H, ddd, *J* = 8.2, 7.5, 1.5 Hz, CH_{Ar}), 1.80–1.79 (2H, m, 2 × CH(H)), 1.21 (2H, br, 2 × CH(H)); δ_{C} (100 MHz; CDCl₃) 179.6 (CO₂H), 150.3 (CNO₂), 134.2 (ArC_{quat}), 133.3 (ArCH), 133.3 (ArCH), 128.8 (ArCH), 125.0 (ArCH), 27.7 (CCO₂H), 17.9 (2 ×

CH₂); *m/z* (APCI+, (M – OH⁻), 100%) Found: 190.0502 C₁₀H₈O₃N requires: 190.0499.

1-(4-Nitrophenyl)cyclopropanecarboxylic acid **95b**

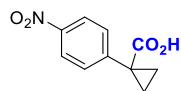

Prepared according to General Procedure H from **94b** (1.11 g, 5.02 mmol) and NaOH (50% aq., 4.0 mL, 50.2 mmol) in THF/MeOH (25 mL) and recrystallised from PhMe to give the *title compound* as white crystals (0.900 g, 4.35 mmol, 87%); mp 146–149 °C (from PhMe); $\nu_{\max}/\text{cm}^{-1}$ 2858br (O–H), 1686s (C=O), 1602m, 1515s (N–O), 1441m, 1353s (N–O), 1220s (C–O), 1111s, 1095m; δ_{H} (400 MHz; CDCl₃) 11.46 (1H, br, CO₂H), 8.17 (2H, d, *J* = 8.8 Hz, 2 × CH_{Ar}), 7.52 (2H, d, *J* = 8.8 Hz, 2 × CH_{Ar}), 1.78 (2H, dd, *J* = 7.3, 4.2 Hz, 2 × CH(H)), 1.33 (2H, dd, *J* = 7.3, 4.2 Hz, 2 × CH(H)); δ_{C} (100 MHz; CDCl₃) 179.4 (CO₂H), 147.4 (CNO₂), 146.0 (ArC_{quat}), 131.6 (2 × ArCH), 123.6 (2 × ArCH), 28.7 (CCO₂H), 17.7 (2 × CH₂); *m/z* (APCI+, (M + H)⁺, 100%) Found: 208.0604 C₁₀H₁₀O₄N requires: 208.0609.

1-(2,4-Dinitrophenyl)cyclopropanecarboxylic acid **95c**

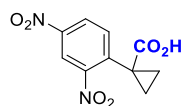

Prepared according to General Procedure H with **94c** (2.66 g, 10.0 mmol) and NaOH (50% aq., 8.0 mL, 100 mmol) in THF/MeOH (50 mL) and recrystallised from ethyl acetate to give the *title compound* as yellow crystals (2.12 g, 8.41 mmol, 84%); mp 155–156 °C (from ethyl acetate); $\nu_{\max}/\text{cm}^{-1}$ 2925br (O–H), 1697s (C=O), 1534s (N–O), 1422m, 1348s (N–O), 1307s (C–O), 1207m, 1151m, 1057m; δ_{H} (400 MHz; CDCl₃) 8.87 (1H, d, *J* = 2.4 Hz, CH_{Ar}), 8.43 (1H, dd, *J* = 8.5, 2.4 Hz, CH_{Ar}), 7.73 (1H, d, *J* = 8.5 Hz, CH_{Ar}), 1.92–1.91 (2H, m, 2 × CH(H)), 1.30 (2H, br, 2 × CH(H)); δ_{C} (100 MHz; CDCl₃) 177.2 (CO₂H), 150.5 (CNO₂), 147.5 (CNO₂), 140.7 (ArC_{quat}), 134.6 (ArCH), 127.4 (ArCH), 120.6 (ArCH), 27.7 (CCO₂H), 18.3 (2 × CH₂); *m/z* (nano-ESI⁻, (M – CO₂H)⁺, 100%) Found: 207.0410 C₉H₇O₄N₂ requires: 207.0411.

1-(4-Fluoro-6-nitrophenyl)cyclopropanecarboxylic acid **95f**

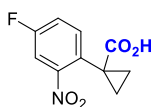

Prepared according to General Procedure H with **94f** (2.39 g, 10.0 mmol) and NaOH (50% aq., 8.0 mL, 100 mmol) in THF/MeOH (50 mL) and recrystallised from PhMe to give the *title compound* as off-white crystals (1.60 g, 7.11 mmol, 71%); mp 157–160 °C (from PhMe); $\nu_{\max}/\text{cm}^{-1}$ 2839br (O–H), 1679s (C=O), 1536s (N–O), 1494m, 1336s (N–O), 1315s (C–F) 1266s (C–O), 1205m, 1136m, 1058m; δ_{H} (400 MHz; CDCl₃) 10.88 (1H, br, CO₂H), 7.74 (1H, dd, $J_{\text{HH}} = 2.7$ Hz, $J_{\text{HF}} = 8.2$ Hz, CH_{Ar}), 7.50 (1H, dd, $J_{\text{HH}} = 8.6$ Hz, $J_{\text{FH}} = 5.5$ Hz, CH_{Ar}), 7.30 (1H, ddd, $J_{\text{HH}} = 8.6$, 2.7 Hz, $J_{\text{HF}} = 7.4$ Hz, CH_{Ar}), 1.82–1.80 (2H, m, 2 × CH(H)), 1.21 (2H, br, 2 × CH(H)); δ_{C} (100 MHz; CDCl₃) 179.5 (CO₂H), 161.5 (d, $J_{\text{CF}} = 252.1$ Hz, CF), 150.7 (d, $J_{\text{CF}} = 8.4$ Hz, CNO₂), 134.9 (d, $J_{\text{CF}} = 8.1$ Hz, ArCH), 130.3 (d, $J_{\text{CF}} = 3.7$ Hz, ArC_{quat}), 120.5 (d, $J_{\text{CF}} = 21.1$ Hz, ArCH), 112.7 (d, $J_{\text{CF}} = 26.7$ Hz, ArCH), 27.1 (CCO₂H), 18.1 (2 × CH₂); δ_{F} (376 MHz; CDCl₃) –109.9 (dd, $J_{\text{HF}} = 7.6$, 13.4 Hz); m/z (APCI+, (M + H)⁺, 100%) Found: 226.0508 C₁₀H₉O₄NF requires: 226.0510.

1-(3-Methoxy-6-nitrophenyl)cyclopropanecarboxylic acid **95g**

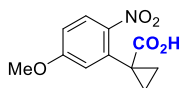

Prepared according to General Procedure H with **94g**¹⁷¹ (2.39 g, 10.0 mmol) and NaOH (50% aq., 8.0 mL, 100 mmol) in THF/MeOH (50 mL) and recrystallised from PhMe to give the *title compound* as brown crystals (1.66 g, 7.00 mmol, 70%); mp 157–159 °C (from PhMe); $\nu_{\max}/\text{cm}^{-1}$ 2920br (O–H), 1687s (C=O), 1509s (NO₂), 1417m, 1311s (NO₂), 1274s (C–O), 1179m, 1081m, 1062m; δ_{H} (400 MHz; CDCl₃) 8.11 (1H, d, $J = 9.1$ Hz, CH_{Ar}), 6.94 (1H, d, $J = 2.8$ Hz, CH_{Ar}), 6.88 (1H, dd, $J = 9.1$, 2.8 Hz, CH_{Ar}), 3.88 (3H, s, CH₃), 1.80 (2H, br, 2 × CH(H)), 1.28–1.21 (2H, m, 2 × CH(H)); δ_{C} (100 MHz; CDCl₃) 179.4 (CO₂H), 163.3 (CNO₂), 143.0 (COMe), 137.2 (ArC_{quat}), 127.9 (ArCH), 118.3 (ArCH), 113.1 (ArCH), 56.0 (CH₃), 28.4 (CCO₂H), 18.2 (2 × CH₂); m/z (APCI+, (M + H)⁺, 100%) 238.0707 Found: C₁₁H₁₂O₅N requires: 238.0710.

1-(2-Methoxyphenyl)cyclopropanecarboxylic acid **95h**

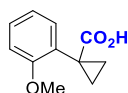

Prepared according to General Procedure H with **94h** (0.302 g, 1.47 mmol) and NaOH (50% aq., 1.18 mL, 14.7 mmol) in THF/MeOH (7.3 mL) and recrystallised from ethyl acetate to give the title compound as white crystals (0.211 g, 1.10 mmol, 75%). Data corresponded to that reported in the literature;¹⁷² mp 76–80 °C (from PhMe; lit.¹⁷² 119–120 °C); $\nu_{\max}/\text{cm}^{-1}$ 2916br (O–H), 1682s (C=O), 1602m, 1586m, 1435s, 1310s, 1181s (O–Me), 1023s; δ_{H} (400 MHz; CDCl₃) 11.94 (1H, br, CO₂H), 7.29 (1H, ddd, $J = 8.1, 7.5, 1.7$ Hz, CH_{Ar}), 7.23 (1H, dd, $J = 7.5, 1.7$ Hz, CH_{Ar}), 6.94–6.88 (2H, m, 2 × CH_{Ar}), 3.86 (3H, s, CH₃), 1.69 (2H, dd, $J = 7.2, 4.1$ Hz, 2 × CH(H)), 1.21 (2H, dd, $J = 7.2, 4.1$ Hz, 2 × CH(H)); δ_{C} (100 MHz; CDCl₃) 181.4 (CO₂H), 159.2 (COMe), 130.7 (ArCH), 129.0 (ArCH), 127.6 (ArC_{quat}), 120.3 (ArCH), 110.7 (ArCH), 55.6 (CH₃), 24.9 (CCO₂H), 17.4 (2 × CH₂); m/z (nano-ESI+, (M + H)⁺, 100%) Found: 193.0859 C₁₁H₁₃O₃ requires: 193.0859.

1-(Benzothiazol-2-yl)cyclopropanecarboxylic acid **95i**

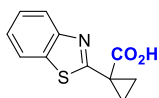

Prepared according to General Procedure H with **94i** (1.24 g, 5.32 mmol) and NaOH (50% aq., 4.26 mL, 53.2 mmol) in THF/EtOH (26.6 mL) and recrystallised from PhMe to give the *title compound* as white crystals¹⁷³ (0.833 g, 3.80 mmol, 71%); $\nu_{\max}/\text{cm}^{-1}$ 2858br (O–H), 2582m (C–N), 1685s (C=O), 1497m, 1410m, 1317s, 1250s (C–O), 1058m, 912m, 835m, 758s (C–S); δ_{H} (400 MHz; CDCl₃) 14.59 (1H, br, CO₂H), 7.96 (1H, d, $J = 8.2$ Hz, CH_{Ar}), 7.84 (1H, d, $J = 8.1$ Hz, CH_{Ar}), 7.53 (1H, ddd, $J = 8.1, 7.3, 1.0$ Hz, CH_{Ar}), 7.43 (1H, ddd, $J = 8.2, 7.3, 1.0$ Hz, CH_{Ar}), 2.26–2.23 (2H, m, 2 × CH(H)), 1.64–1.61 (2H, m, 2 × CH(H)); δ_{C} (100 MHz; CDCl₃) 174.8 (CO₂H), 171.8 (ArC_{quat}), 150.4 (ArC_{quat}), 132.9 (ArC_{quat}), 127.2 (ArCH), 126.0 (ArCH), 122.0 (ArCH), 121.8 (ArCH), 27.5 (CCO₂H), 26.5 (2 × CH₂); m/z (nano-ESI-, (M – H)⁺, 100%) Found: 218.0279 C₁₁H₈O₂NS requires: 218.0281.

1-(Benzoxazol-2-yl)cyclopropanecarboxylic acid **95m**

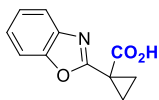

Prepared according to General Procedure H with **94m** (0.92 g, 4.24 mmol) and NaOH (50% aq., 3.40 mL, 42.4 mmol) in THF/MeOH (21 mL) and recrystallised from PhMe to give the *title compound* as brown crystals (0.843 g, 4.15 mmol, 98%); mp 118–120 °C (from PhMe); $\nu_{\max}/\text{cm}^{-1}$ 2924br (O–H), 2854m (C–N), 1731s (C=O), 1561s, 1419s, 1319s, 1204m, 1163m, 1101s (C–O), 1041m; δ_{H} (400 MHz; CDCl₃) 13.86 (1H, br, CO₂H), 7.69–7.67 (1H, m, CH_{Ar}), 7.50–7.48 (1H, m, CH_{Ar}), 7.41–7.35 (2H, m, 2 × CH_{Ar}), 2.10–2.07 (2H, m, 2 × CH(H)), 1.94–1.91 (2H, m, 2 × CH(H)); δ_{C} (100 MHz; CDCl₃) 170.6 (CO₂H), 166.3 (ArC_{quat}), 149.9 (ArC_{quat}), 138.8 (ArC_{quat}), 125.8 (ArCH), 125.5 (ArCH), 119.1 (ArCH), 110.9 (ArCH), 22.7 (CCO₂H), 22.4 (2 × CH₂); m/z (nano-ESI+, (M – H)⁺, 100%) Found: 202.0510 C₁₁H₈O₃N requires: 202.0510.

1-(Quinolin-2-yl)cyclopropanecarboxylic acid **95n**

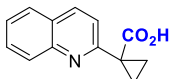

Prepared according to General Procedure H with **94n** (0.701 g, 3.09 mmol) and NaOH (50% aq., 2.48 mL, 30.9 mmol) in THF/MeOH (15.5 mL) and recrystallised from PhMe to give the *title compound* as brown crystals (0.398 g, 1.87 mmol, 61%); mp 110–113 °C (from PhMe); IR $\nu_{\max}/\text{cm}^{-1}$ 2925br (O–H), 2360m (C–N), 1687s (C=O), 1521s, 1429s, 1347, 1305s (C–O), 1219m, 1144m, 1093m; δ_{H} (400 MHz; CDCl₃) 8.23 (1H, d, $J = 8.9$ Hz, CH_{Ar}), 8.04 (1H, d, $J = 8.5$ Hz, CH_{Ar}), 7.83 (1H, dd, $J = 8.1, 1.0$ Hz, CH_{Ar}), 7.79 (1H, ddd, $J = 8.5, 7.1, 1.4$ Hz, CH_{Ar}), 7.60 (1H, ddd, $J = 8.1, 7.1, 1.0$ Hz, CH_{Ar}), 6.92 (1H, d, $J = 8.9$ Hz, CH_{Ar}), 2.20–2.17 (2H, m, 2 × CH(H)), 1.57–1.54 (2H, m, 2 × CH(H)); δ_{C} (100 MHz; CDCl₃) 174.6 (CO₂H), 161.3 (ArC_{quat}), 143.1 (ArC_{quat}), 139.5 (ArCH), 131.4 (ArCH), 127.7 (ArCH), 127.4 (ArCH), 126.7 (ArCH), 126.1 (ArC_{quat}), 115.3 (ArCH), 26.4 (CCO₂H), 24.1 (2 × CH₂); m/z (APCI+, (M + H)⁺, 100%) Found: 214.0864 C₁₃H₁₂O₂N requires: 214.0863.

1-(2-Nitrophenyl)-2-phenylcyclopropanecarboxylic acid **95q**

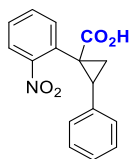

Prepared according to General Procedure H from **94q** (0.693 g, 2.33 mmol) and NaOH (50% aq., 1.86 mL, 23.3 mmol) in THF/MeOH (12 mL) and recrystallised from PhMe to give the *title compound* as yellow crystals (0.511 g, 1.81 mmol, 78%); mp 158–160 °C (from PhMe); $\nu_{\max}/\text{cm}^{-1}$ 2852br (O–H), 1677s (C=O), 1516s (N–O), 1499s, 1458m, 1348s (N–O), 1303s (C–O), 1218m (C–O), 1107m, 1061m; δ_{H} (400 MHz; CDCl_3) 11.15 (1H, s, CO_2H), 7.98 (2H, d, $J = 8.7$ Hz, $2 \times \text{CH}_{\text{Ar}}$), 7.21 (2H, d, $J = 8.7$ Hz, $2 \times \text{CH}_{\text{Ar}}$), 7.10–7.09 (3H, m, $3 \times \text{CH}_{\text{Ar}}$), 6.81–6.79 (2H, m, $2 \times \text{CH}_{\text{Ar}}$), 3.28 (1H, dd, $J = 9.3, 7.5$ Hz, CHPh), 2.30 (1H, dd, $J = 9.3, 5.3$ Hz, $1 \times \text{CH}(\text{H})$), 2.06 (1H, dd, $J = 7.5, 5.3$ Hz, $1 \times \text{CH}(\text{H})$); δ_{C} (100 MHz; CDCl_3) 178.9 (CO_2H), 147.2 (CNO_2), 141.8 (ArC_{quat}), 134.7 (ArC_{quat}), 132.9 (ArCH), 128.4 (ArCH), 128.1 (ArCH), 127.4 (ArCH), 123.1 (ArCH), 36.8 (CCO_2H), 34.7 (CPh), 20.4 (CH_2); m/z (APCI+, $(\text{M} + \text{H})^+$, 100%) Found: 284.0919 $\text{C}_{16}\text{H}_{14}\text{O}_4\text{N}$ requires: 284.0917.

General procedure I for synthesis of cyclopropanecarboxylic acids from nitriles:

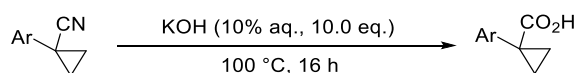

The appropriate methyl arylcyclopropane carbonitrile (1.00 equiv.) was added to KOH (10% aq., 10.0 equiv.) and the mixture was stirred for 16 h at 100 °C. The reaction mixture was allowed to cool to room temperature and was washed three times with Et_2O . The aqueous layer was then acidified (HCl, 35% aq.) to pH 3–4 and then extracted three times with Et_2O . The combined organic layers from the second washing were dried (MgSO_4), filtered and concentrated *in vacuo*. The crude product was recrystallised to yield the carboxylic acid.

1-(3-Nitrophenyl)cyclopropanecarboxylic acid **95d**

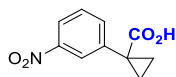

Prepared according to General Procedure I from **94d** (2.21 g, 10.0 mmol) and KOH (10% aq., 56 mL, 100 mmol) and recrystallised from PhMe to give the *title compound* as orange crystals (1.67 g, 8.07 mmol, 81%); mp 189–191 °C (from PhMe); $\nu_{\max}/\text{cm}^{-1}$ 3033br (O–H), 1685s (C=O), 1515s (N–O), 1442m (C–O–H), 1350s (N–O), 1313s (C–O), 1220s (C–O), 1114s, 1069s; δ_{H} (400 MHz; CDCl_3) 8.21 (1H, dd, $J = 2.1, 1.6$ Hz, CH_{Ar}), 8.13 (1H, ddd, $J = 8.2, 2.1, 0.9$ Hz, CH_{Ar}), 7.69 (1H, ddd, $J = 7.6, 1.6, 0.9$ Hz, CH_{Ar}), 7.48 (1H, ddd, $J = 8.2, 7.6$ Hz, CH_{Ar}), 1.79–1.76 (2H, m, $2 \times \text{CH}(\text{H})$), 1.34–1.31 (2H, m, $2 \times \text{CH}(\text{H})$); δ_{C} (100 MHz; CDCl_3) 179.7 (CO₂H), 148.3 (CNO₂), 140.8 (ArC_{quat}), 137.0 (ArCH), 129.3 (ArCH), 125.6 (ArCH), 122.8 (ArCH), 28.7 (CCO₂H), 17.6 ($2 \times \text{CH}_2$); m/z (nano-ESI[–], (M – H)⁺, 100%) Found: 206.0456 C₁₀H₈O₄N requires: 206.0459.

1-(2-Fluorophenyl)cyclopropanecarboxylic acid **95e**

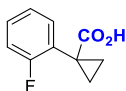

Prepared according to General Procedure I with **94e** (1.94 g, 10.0 mmol) and KOH (10% aq., 56 mL, 100 mmol) and recrystallised from PhMe to give the *title compound* as white crystals (1.57 g, 8.72 mmol, 87%); mp 96–99 °C (from PhMe); $\nu_{\max}/\text{cm}^{-1}$ 2853br (O–H), 1685s (C=O), 1495s, 1426m, 1311s (C–F), 1220s (C–O), 1155m, 1076m; δ_{H} (400 MHz; CDCl_3) 9.53 (1H, br, CO₂H), 7.29–7.24 (2H, m, $2 \times \text{CH}_{\text{Ar}}$), 7.10–7.01 (2H, m, $2 \times \text{CH}_{\text{Ar}}$), 1.74–1.71 (2H, m, $2 \times \text{CH}(\text{H})$), 1.28–1.25 (2H, m, $2 \times \text{CH}(\text{H})$); δ_{C} (100 MHz; CDCl_3) 180.0 (CO₂H), 162.7 (d, $J_{\text{CF}} = 248$ Hz, CF), 131.6 (d, $J_{\text{CF}} = 3.6$ Hz, ArCH), 129.6 (d, $J_{\text{CF}} = 8.3$ Hz, ArCH), 126.3 (d, $J_{\text{CF}} = 14.6$ Hz, ArC_{quat}), 123.9 (d, $J_{\text{CF}} = 3.7$ Hz, ArCH), 115.5 (d, $J_{\text{CF}} = 21.7$ Hz, ArCH), 23.8 (CCO₂H), 17.3 ($2 \times \text{CH}_2$); δ_{F} (376 MHz; CDCl_3) –114.18 to –114.24 (m); m/z (nano-ESI[–], (M – H)⁺, 100%) Found: 179.0513 C₁₀H₈O₂F requires: 179.0514.

1-(Pyridin-2-yl)cyclopropanecarboxylic acid **95j**

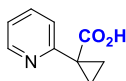

Prepared according to General Procedure I with 1-(pyridin-2-yl)cyclopropanecarbonitrile¹⁷⁴ (**94j**) (3.68 g, 20.8 mmol) and KOH

(10% aq., 117 mL, 208 mmol) to give the *title compound* as a yellow wax (3.10 g, 19.0 mmol, 91%); $\nu_{\max}/\text{cm}^{-1}$ 2917br (O–H), 2460m (C–N), 1692s (C=O), 1573s, 1440s, 1319s, 1271s (C–O), 1189m, 1090m, 1050m; δ_{H} (400 MHz; CDCl_3) 12.32 (1H, br, CO_2H), 8.46 (1H, dd, $J = 5.2, 0.8$ Hz, CH_{Ar}), 7.82 (1H, ddd, $J = 8.3, 7.6, 1.8$ Hz, CH_{Ar}), 7.30 (1H, ddd, $J = 7.6, 5.2, 0.8$ Hz, CH_{Ar}), 6.95 (1H, d, $J = 8.3$ Hz, CH_{Ar}), 2.09 (2H, dd, $J = 7.8, 4.4$ Hz, $2 \times \text{CH}(\text{H})$), 1.41 (2H, dd, $J = 7.8, 4.4$ Hz, $2 \times \text{CH}(\text{H})$); δ_{C} (100 MHz; CDCl_3) 174.6 (CO_2H), 160.9 (ArC_{quat}), 144.4 (ArCH), 139.3 (ArCH), 121.5 (ArCH), 117.8 (ArCH), 25.3 (CCO_2H), 24.5 ($2 \times \text{CH}_2$); m/z (nano-ESI $^-$, $(\text{M} - \text{H})^+$, 100%) Found: 162.0564 $\text{C}_9\text{H}_8\text{O}_2\text{N}$ requires: 162.0561.

1-(Thiophen-2-yl)cyclopropanecarboxylic acid **95k**

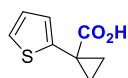

Prepared according to General Procedure I with 1-(thiophen-2-yl)cyclopropanecarbonitrile¹⁷⁵ (**94k**) (1.36 g, 7.47 mmol) and KOH (10% aq., 42 mL, 75 mmol) and recrystallised from PhMe to give the title compound as white crystals (1.12 g, 6.67 mmol, 89%). Data corresponded to that reported in the literature;¹⁷⁶ mp 79–81 °C (from PhMe; lit.¹⁷⁶ 138–139 °C); $\nu_{\max}/\text{cm}^{-1}$ 1680s (C=O), 1453s, 1315s, 1275s (C–O), 1198s, 1082m, 1033s; δ_{H} (400 MHz; CDCl_3) 11.53 (1H, s, CO_2H), 7.21 (1H, dd, $J = 5.1, 1.1$ Hz, CH_{Ar}), 6.97 (1H, dd, $J = 3.5, 1.1$ Hz, CH_{Ar}), 6.92 (1H, dd, $J = 5.1, 3.5$ Hz, CH_{Ar}), 1.79–1.77 (2H, m, $2 \times \text{CH}(\text{H})$), 1.42–1.39 (2H, m, $2 \times \text{CH}(\text{H})$); δ_{C} (100 MHz; CDCl_3) 180.2 (CO_2H), 142.9 (ArC_{quat}), 128.5 (ArCH), 126.8 (ArCH), 125.5 (ArCH), 23.8 (CCO_2H), 20.5 ($2 \times \text{CH}_2$).

General procedure J for protodecarboxylation:

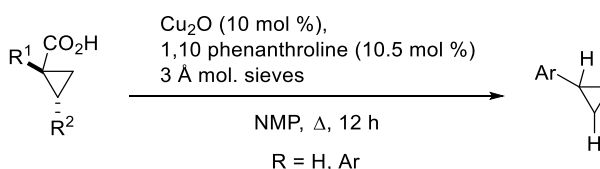

An oven-dried microwave vial (10 ml) was charged with the appropriate cyclopropanecarboxylic acid (0.500 mmol), NMP (1.00 mL), Cu_2O (7.15 mg, 0.05 mmol), 1,10-phenanthroline (9.46 mg, 0.0525 mmol) and 3 Å molecular

sieves (150 mg). The reaction flask was sealed and the reaction mixture was stirred at the appropriate temperature for 16 h, before being cooled and diluted with aqueous HCl (1 M) and then extracted five times with ethyl acetate. The combined organic layers were washed with water and brine, dried (MgSO₄), filtered and concentrated *in vacuo*. The crude product was purified by flash column chromatography (SiO₂) to yield the decarboxylated cyclopropane.

2-Nitrophenylcyclopropane 97a

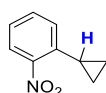

Prepared according to General Procedure J from **95a** (0.104 g, 0.500 mmol) at 135 °C and purified by flash column chromatography (5% Et₂O in petrol) to give the title compound as a yellow oil (0.068 g, 0.415 mmol, 83%). Data corresponded to that reported in the literature;¹⁷⁷ $\nu_{\text{max}}/\text{cm}^{-1}$ 3007s, 1738s, 1610s, 1520s (N–O), 1346s (N–O), 1284s, 1219s, 1029s; δ_{H} (400 MHz; CDCl₃) 7.80 (1H, dd, $J = 8.2, 1.3$ Hz, CH_{Ar}), 7.47 (1H, ddd, $J = 7.7, 7.5, 0.9$ Hz, CH_{Ar}), 7.29 (1H, ddd, $J = 8.2, 7.7, 1.3$ Hz, CH_{Ar}), 7.15 (1H, dd, $J = 7.5, 0.9$ Hz, CH_{Ar}), 2.42–2.35 (1H, m, CH), 1.07–1.02 (2H, m, 2 × CH(H)), 0.72–0.68 (2H, m, 2 × CH(H)); δ_{C} (100 MHz; CDCl₃) 151.3 (CNO₂), 138.2 (ArC_{quat}), 132.7 (ArCH), 128.1 (ArCH), 126.5 (ArCH), 124.2 (ArCH), 12.6 (CH), 8.2 (2 × CH₂).

4-Nitrophenylcyclopropane 97b

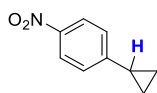

Prepared according to General Procedure J from **95b** (0.104 g, 0.500 mmol) at 135 °C and purified by flash column chromatography (5% Et₂O in petrol) to give the title compound as a yellow oil (0.069 g, 0.425 mmol, 85%). Data corresponded to that reported in the literature;¹⁷⁷ $\nu_{\text{max}}/\text{cm}^{-1}$ 3114s, 1732s, 1603s, 1514s (N–O), 1436s, 1341s (N–O), 1185s, 1112s; δ_{H} (400 MHz; CDCl₃) 8.12–8.08 (2H, m, 2 × CH_{Ar}), 7.17–7.14 (2H, m, 2 × CH_{Ar}), 2.02–1.96 (1H, tt, $J = 8.3, 5.0$ Hz, CH), 1.15–1.12 (2H, m, 2 × CH(H)), 0.84–0.79 (2H, m, 2 × CH(H)); δ_{C} (100 MHz; CDCl₃) 152.8 (CNO₂), 145.9 (ArC_{quat}), 126.1 (2 × ArCH), 123.8 (2 × ArCH), 16.0 (CH), 11.1 (2 × CH₂).

(2,4-Dinitrophenyl)cyclopropane 97c

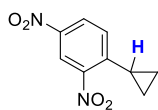

Prepared according to General Procedure J from **95c** (0.126 g, 0.500 mmol) at 120 °C and purified by flash column chromatography (10% Et₂O in petrol) to give the title compound as a yellow oil (0.091 g, 0.435 mmol, 87%). Data corresponded to that reported in the literature;¹⁷⁸ $\nu_{\max}/\text{cm}^{-1}$ 3100br, 1534s (N–O), 1416m, 1340s (N–O), 1211m, 1189m, 1060m; δ_{H} (400 MHz; CDCl₃) 8.67 (1H, d, $J = 2.5$ Hz, CH_{Ar}), 8.32 (1H, dd, $J = 8.8, 2.5$ Hz, CH_{Ar}), 7.26 (1H, d, $J = 8.8$ Hz, CH_{Ar}), 2.53–2.46 (1H, m, CH), 1.29–1.24 (2H, m, 2 × CH(H)), 0.91–0.86 (2H, m, 2 × CH(H)); δ_{C} (100 MHz; CDCl₃) 145.9 (ArC_{quat}), 128.3 (ArCH) 126.9 (ArCH), 119.9 (ArCH), 119.9 (ArCH), 12.9 (CH), 10.4 (2 × CH₂).

(2-Fluorophenyl)cyclopropane 97e

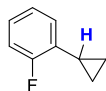

Prepared according to the General Procedure J from **95e** (0.090 g, 0.500 mmol) at 150 °C and purified by flash column chromatography (pentane) give the *title compound* as a colourless oil (0.042 g, 0.305 mmol, 61%); $\nu_{\max}/\text{cm}^{-1}$ 1597m, 1510m, 1425m, 1382m (C–F), 1211m, 1166m, 1082m; δ_{H} (400 MHz; CDCl₃) 7.14–7.09 (1H, m, CH_{Ar}), 7.05–6.98 (2H, m, 2 × CH_{Ar}), 6.90 (1H, ddd, $J = 8.7, 7.5, 1.1$ Hz, CH_{Ar}), 2.10 (1H, tt, $J = 8.7, 8.6$ Hz, CH), 1.00–0.96 (2H, m, 2 × CH(H)), 0.75–0.71 (2H, m, 2 × CH(H)); δ_{C} (100 MHz; CDCl₃) 162.0 (d, $J_{\text{CF}} = 244$ Hz, CF), 130.8 (d, $J_{\text{CF}} = 13.9$ Hz, ArC_{quat}), 126.7 (d, $J_{\text{CF}} = 8.2$ Hz, ArCH), 126.1 (d, $J_{\text{CF}} = 4.4$ Hz, ArCH), 124.0 (d, $J_{\text{CF}} = 3.7$ Hz, ArCH), 115.1 (d, $J_{\text{CF}} = 22.2$ Hz, ArCH), 8.8 (d, $J_{\text{CF}} = 5.3$ Hz, CH), 7.90 (2 × CH₂); δ_{F} (376 MHz; CDCl₃) –120.26 to –120.32 (m); m/z (APCI+, (M + H)⁺, 100%) Found: 137.0757 C₉H₁₀F requires: 137.0761.

1-(4-Fluoro-6-nitrophenyl)cyclopropane 97f

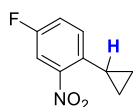

Prepared according to General Procedure J from **95f** (0.113 g, 0.500 mmol) at 175 °C and purified by flash column chromatography (5% Et₂O in petrol) to give the *title compound* as

a colourless oil (0.045 g, 0.250 mmol); $\nu_{\max}/\text{cm}^{-1}$ 3089br, 1531s (N–O), 1500m, 1350s (N–O), 1246s (C–F); δ_{H} (400 MHz; CDCl_3) 7.56 (1H, dd, $J_{\text{HH}} = 8.3$ Hz, $J_{\text{HF}} = 2.1$ Hz, CH_{Ar}), 7.24–7.16 (2H, m, $2 \times \text{CH}_{\text{Ar}}$), 2.38 (1H, tt, $J_{\text{HH}} = 8.3$ Hz, $J_{\text{HF}} = 5.5$ Hz, CH), 1.07–1.02 (2H, m, $2 \times \text{CH}(\text{H})$), 0.68–0.64 (2H, m, $2 \times \text{CH}(\text{H})$); δ_{C} (150 MHz; CDCl_3) 160.2 (d, $J_{\text{CF}} = 248.8$ Hz, CF), 151.4 (d, $J_{\text{CF}} = 8.1$ Hz, CNO_2), 134.1 (d, $J_{\text{CF}} = 3.7$ Hz, ArC_{quat}), 130.3 (d, $J_{\text{CF}} = 7.8$ Hz, ArCH), 120.0 (d, $J_{\text{CF}} = 21.1$ Hz, ArCH), 111.8 (d, $J_{\text{CF}} = 26.2$ Hz, ArCH), 12.5 (CH), 7.8 ($2 \times \text{CH}_2$); δ_{F} (376 MHz; CDCl_3) –113.6 (dd, $J_{\text{HF}} = 7.2, 13.6$ Hz); m/z (APCI+, $(\text{M} + \text{H})^+$, 100%) Found: 182.0610 $\text{C}_9\text{H}_9\text{O}_2\text{NF}$ requires: 182.0612.

(3-Methoxy-6-nitrophenyl)cyclopropane **97g**

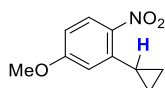

Prepared according to General Procedure J from **95g** (0.119 g, 0.500 mmol) at 175 °C and purified by flash column chromatography (5% Et_2O in petrol) to give the *title compound* as a yellow oil (0.070 g, 0.360 mmol, 72%); $\nu_{\max}/\text{cm}^{-1}$ 3087br, 1607s, 1578s, 1508s (N–O) 1439s (N–O), 1314s, 1185s, 1026s (O–Me); δ_{H} (400 MHz; CDCl_3) 7.95 (1H, d, $J = 9.0$ Hz, CH_{Ar}), 6.75 (1H, dd, $J = 9.0, 2.6$ Hz, CH_{Ar}), 6.61 (1H, d, $J = 2.6$ Hz, CH_{Ar}), 3.85 (3H, s, CH_3), 2.54 (1H, tt, $J = 8.4, 5.6$ Hz, CH), 1.08–1.03 (2H, m, $2 \times \text{CH}(\text{H})$), 0.71–0.67 (2H, m, $2 \times \text{CH}(\text{H})$); δ_{C} (100 MHz; CDCl_3) 163.2 (CNO_2), 144.2 (COMe), 141.7 (ArC_{quat}), 127.4 (ArCH), 113.4 (ArCH), 111.1 (ArCH), 55.9 (CH_3), 13.6 (CH), 8.4 ($2 \times \text{CH}_2$); m/z (APCI+, $(\text{M} + \text{H})^+$, 100%) Found: 194.0810 $\text{C}_{10}\text{H}_{12}\text{O}_3\text{N}$ requires: 194.0812.

2-Methoxyphenylcyclopropane **97h**

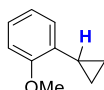

Prepared according to General Procedure J from **95h** (0.096 g, 0.500 mmol) at 200 °C and purified by flash column chromatography (petrol) to give the *title compound* as a pale yellow oil (0.029 g, 0.195 mmol, 39%). Data corresponded to that reported in the literature;^{132f} $\nu_{\max}/\text{cm}^{-1}$ 3072br, 1605s, 1578s, 1320s, 1186s, 1020s (O–Me); δ_{H} (400 MHz; CDCl_3) 7.16 (1H, ddd, $J = 8.2, 6.2, 2.0$ Hz, CH_{Ar}), 6.92–6.86 (3H, m, $3 \times \text{CH}_{\text{Ar}}$),

3.89 (3H, s, CH₃) 2.25 (1H, tt, $J = 5.3, 5.2$ Hz, CH), 0.98–0.93 (2H, m, 2 × CH(H)), 0.70–0.66 (2H, m, 2 × CH(H)); δ_C (100 MHz; CDCl₃) 158.4 (COMe), 132.1 (ArC_{quat}), 126.4 (ArCH), 124.9 (ArCH), 120.7 (ArCH), 110.4 (ArCH), 55.7 (CH₃), 9.5 (CH), 7.8 (2 × CH₂).

Cyclopropylbenzene **97i**

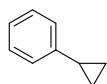

Prepared according to General Procedure J from 1-phenylcyclopropanecarboxylic acid (**84**) or *trans*-2-phenylcyclopropanecarboxylic acid (**95i**) (0.081 g, 0.500 mmol) at 200 °C and purified by flash column chromatography (pentane) to give the title compound as a yellow oil (from **84**: 0.030 g, 0.250 mmol, 50%; from **95i**: 0.027 g, 0.225 mmol, 45%); Data corresponded to the commercially available material; $\nu_{\max}/\text{cm}^{-1}$ 3028s, 1604s, 1496s, 1464s, 1431s, 1220s, 1174s, 1080s, 1046s; δ_H (400 MHz; CDCl₃) 7.38–7.34 (2H, m, 2 × CH_{Ar}), 7.27–7.25 (1H, m, CH_{Ar}), 7.19–7.17 (2H, m, 2 × CH_{Ar}), 2.01–1.96 (1H, m, CH), 1.07–1.03 (2H, m, 2 × CH(H)), 0.81–0.79 (2H, m, 2 × CH(H)); δ_C (100 MHz; CDCl₃) 144.1 (ArC_{quat}), 128.4 (ArCH), 125.8 (ArCH), 125.5 (ArCH), 15.5 (CH), 9.3 (2 × CH₂).

(Pyridin-2-yl)cyclopropane **97j**

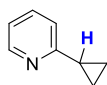

Prepared according to General Procedure J from **95j** (0.082 g, 0.500 mmol) at 150 °C and purified by flash column chromatography (5% Et₂O in petrol) to give the title compound as a colourless oil (0.036 g, 0.300 mmol, 60%). Data corresponded to that reported in the literature;¹⁷⁹ $\nu_{\max}/\text{cm}^{-1}$ 2925br, 2360br, 2341m (C–N), 1031s; δ_H (400 MHz; CDCl₃) 8.44 (1H, ddd, $J = 4.9, 1.7, 0.8$ Hz, CH_{Ar}), 7.52 (1H, ddd, $J = 8.7, 7.6, 1.7$ Hz, CH_{Ar}), 7.12 (1H, ddd, $J = 8.7, 1.2, 0.8$ Hz, CH_{Ar}), 7.02 (1H, ddd, $J = 7.6, 4.9, 1.2$ Hz, CH_{Ar}), 2.06–1.99 (1H, m, CH), 1.02–0.97 (4H, m, 2 × CH₂); δ_C (100 MHz; CDCl₃) 163.0 (ArC_{quat}), 149.1 (ArCH), 136.3 (ArCH), 121.0 (ArCH), 120.5 (ArCH), 17.2 (CH), 10.0 (2 × CH₂).

(Benzothiazol-2-yl)cyclopropane **97l**

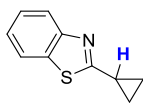

Prepared according to General Procedure J from **95l** (0.110 g, 0.500 mmol) at 100 °C and purified by flash column chromatography (5% Et₂O in petrol) to give the title compound as a yellow oil (0.050 g, 0.285 mmol, 57%). Data corresponded to that reported in the literature;¹⁸⁰ $\nu_{\text{max}}/\text{cm}^{-1}$ 2198m (C–N), 1620m, 1506m, 1428m, 1305m, 1085m, 753s (C–S); δ_{H} (400 MHz; CDCl₃) 7.89 (1H, d, $J = 8.3$ Hz, CH_{Ar}), 7.78 (1H, d, $J = 7.9$ Hz, CH_{Ar}), 7.43–7.39 (1H, m, CH_{Ar}), 7.32–7.28 (1H, m, CH_{Ar}), 2.43–2.36 (1H, m, CH), 1.23–1.21 (4H, m, 2 × CH₂); δ_{C} (150 MHz; CDCl₃) 174.7 (ArC_{quat}), 153.5 (ArC_{quat}), 134.3 (ArC_{quat}), 126.2 (ArCH), 124.6 (ArCH), 122.1 (ArCH), 121.7 (ArCH), 15.5 (CH), 11.8 (2 × CH₂); m/z (APCI+, (M + H)⁺, 100%) Found: 176.0527 C₁₀H₁₀NS requires: 176.0528.

(Benzoxazol-2-yl)cyclopropane **97m**

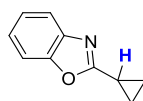

Prepared according to General Procedure J from **95m** (0.102 g, 0.500 mmol) at 150 °C and purified by flash column chromatography (5% Et₂O in petrol) to give the title compound as a yellow oil (0.052 g, 0.325 mmol, 65%). Data corresponded to that reported in the literature;¹⁸¹ $\nu_{\text{max}}/\text{cm}^{-1}$ 3095br, 2849m (C–N), 1429s, 1300s, 1207m, 1167m, 1039m; δ_{H} (400 MHz; CDCl₃) 7.61–7.59 (1H, m, CH_{Ar}), 7.44–7.41 (1H, m, CH_{Ar}), 7.29–7.26 (2H, m, 2 × CH_{Ar}), 2.28–2.21 (1H, m, CH), 1.27 (2H, m, 2 × CH(H)), 1.19–1.14 (2H, m, 2 × CH(H)); δ_{C} (150 MHz; CDCl₃) 168.8 (ArC_{quat}), 150.6 (ArC_{quat}), 141.8 (ArC_{quat}), 124.2 (ArCH), 124.1 (ArCH), 119.2 (ArCH), 110.2 (ArCH), 9.5 (CH), 9.3 (2 × CH₂); m/z (APCI+, (M + H)⁺, 100%) Found: 160.0755 C₁₀H₁₀ON requires: 160.0757.

(Quinolin-2-yl)cyclopropane **97n**

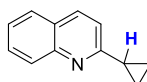

Prepared according to the General Procedure J from **95n** (0.107 g, 0.500 mmol) at 90 °C and purified by flash column chromatography (5% Et₂O in petrol) to give the title compound as

a yellow oil (0.080 g, 0.475 mmol, 95%). Data corresponded to that reported in the literature;¹⁸² $\nu_{\text{max}}/\text{cm}^{-1}$ 2198m (C–N), 1602m, 1504m, 1427m, 1377m, 1215m, 1166m, 1083m; δ_{H} (400 MHz; CDCl₃) 8.00–7.96 (2H, m, 2 × CH_{Ar}), 7.73 (1H, dd, $J = 8.1, 1.1$ Hz, CH_{Ar}), 7.64 (1H, ddd, $J = 8.5, 7.0, 1.4$ Hz, CH_{Ar}), 7.42 (1H, ddd, $J = 8.1, 7.0, 1.1$ Hz, CH_{Ar}), 7.16 (1H, d, $J = 8.5$ Hz, CH_{Ar}), 2.24 (1H, m, CH), 1.19–1.15 (2H, m, 2 × CH(H)), 1.13–1.07 (2H, m, 2 × CH(H)); δ_{C} (100 MHz; CDCl₃) 163.5 (ArC_{quat}), 148.1 (ArC_{quat}), 135.9 (ArCH), 129.4 (ArCH), 128.8 (ArCH), 127.6 (ArCH), 126.9 (ArC_{quat}), 125.3 (ArCH), 119.5 (ArCH), 18.2 (CH), 10.4 (2 × CH₂); m/z (APCI+, (M + H)⁺, 100%) Found: 170.0961 C₁₂H₁₂N requires: 170.0961.

Experimental data for Chapter 5

(*trans*-2-Iodocyclopropyl)benzene 108

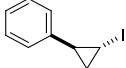
 Prepared according to the literature procedure¹⁴⁶ from *trans*-2-phenylcyclopropane-1-carboxylic acid (5.59 g, 34.5 mmol) to give the title compound as a pale orange oil (1.01 g, 4.14 mmol, 12%). Data corresponded to that reported in the literature;¹⁸³ $\nu_{\max}/\text{cm}^{-1}$ 1498s, 1209s, 1179m, 1093m, 1073m, 1030m, 1005m, 970m; δ_{H} (400 MHz; CDCl₃) 7.35–7.32 (2H, m, 2 × CH_{Ar}), 7.29–7.24 (1H, m, CH_{Ar}), 7.12–7.10 (2H, d, $J = 7.7$ Hz, 2 × CH_{Ar}), 2.63–2.59 (1H, m, CHPh), 2.41–2.36 (1H, m, CHI), 1.56–1.51 (1H, m, CH(H)), 1.48–1.43 (1H, m, CH(H)); δ_{C} (100 MHz; CDCl₃) 140.4 (ArC_{quat}), 128.7 (ArCH), 126.6 (ArCH), 125.9 (ArCH), 27.8 (CPh), 20.0 (CH₂), –13.1 (CHI).

(*E*)-Iodoacrylic acid 114

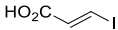
 Prepared according to the literature procedure¹⁴⁷ from propiolic acid (4.38 mL, 4.99 g, 71.2 mmol) to give the title compound as white crystals (12.4 g, 62.7 mmol, 88%). Data corresponded to that reported in the literature;¹⁴⁷ mp 146–149 °C (lit.¹⁴⁷ 147–149 °C); $\nu_{\max}/\text{cm}^{-1}$ 1659s (C=O), 1581s (C=C), 1425s, 1274s, 1220s; δ_{H} (400 MHz; CDCl₃) 8.10 (1H, d, $J = 14.9$ Hz, CHCO₂H), 6.93 (1H, d, $J = 14.9$ Hz, CHI); δ_{C} (100 MHz; CDCl₃) 168.8 (CO₂H), 135.8 (CHI), 102.8 (CCO₂H).

(*E*)-Iodoprop-2-en-1-ol 113

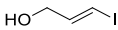
 Prepared according to the literature procedure¹⁴⁹ from **114** (18.07 g, 85.3 mmol) to give the title compound as a colourless oil (8.01 g, 43.5 mmol, 51%). Data corresponded to that reported in the literature;¹⁸⁴ $\nu_{\max}/\text{cm}^{-1}$ 3330w (O–H), 2863w, 1606s (C=C), 1233s, 1172s, 1076s, 930m; δ_{H} (400 MHz; CDCl₃) 6.67 (1H, dt, $J = 14.5, 5.4$ Hz, CHCH₂OH), 6.37 (1H, dt, $J = 14.5, 1.6$ Hz, CHI), 4.05 (2H, dt, $J = 5.4, 1.6$ Hz, CH₂), 2.55 (1H, br, OH); δ_{C} (100 MHz; CDCl₃) 144.8 (CHI), 77.9 (CCH₂OH), 60.1 (CH₂OH).

(E)-(2-Iodocyclopropyl)methanol **115**

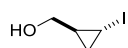

Prepared according to the literature procedure¹⁴⁰ from **113** (0.970 g, 5.27 mmol) to give the title compound as a colourless oil (0.428 g, 2.16 mmol, 41%). Data corresponded to that reported in the literature;¹⁴⁰ $\nu_{\max}/\text{cm}^{-1}$ 3320w (O–H), 2869w, 1391s, 1247s, 1209m, 1192s, 1042s, 1018m; δ_{H} (400 MHz; CDCl_3) 3.59 (1H, dd, $J = 11.4, 6.2$ Hz, $\text{CH}(\text{H})\text{OH}$), 3.50 (1H, dd, $J = 11.4, 6.8$ Hz, $\text{CH}(\text{H})\text{OH}$), 2.25 (1H, ddd, $J = 8.5, 4.5, 4.1$ Hz, CHI), 1.76 (1H, br, OH), 1.55–1.47 (1H, m, CHCH_2OH), 1.02–0.95 (cpr CH_2); δ_{C} (100 MHz; CDCl_3) 64.9 (CH_2OH), 25.5 (CHCH_2OH), 14.6 (cpr CH_2), –18.5 (CHI).

(E)-Methyl-3-iodoacrylate **116**

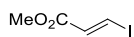

To a solution of **114** (5.67 g, 28.7 mmol) in MeOH (30 mL) was added H_2SO_4 (0.14 mL, 2.9 mmol) and the solution was stirred at 70 °C for 12 h. The MeOH was removed *in vacuo* and water was added to the crude residue. NaOH (15% w/v) was added until the mixture reached pH 10. The aqueous phase was then washed with Et_2O (3×20 mL) and the combined organics were dried (MgSO_4), filtered and concentrated *in vacuo* to give the title compound as a yellow oil (5.29 g, 25.0 mmol, 87%). Data corresponded to that reported in the literature;¹⁸⁵ $\nu_{\max}/\text{cm}^{-1}$ 1730s (C=O), 1597s (C=C), 1444s, 1325s, 1220s; δ_{H} (400 MHz; CDCl_3) 7.89 (1H, d, $J = 14.9$ Hz, CHCO_2Me), 6.89 (1H, d, $J = 14.9$ Hz, CHI), 3.75 (3H, s, CH_3); δ_{C} (100 MHz; CDCl_3) 164.8 (CO_2Me), 136.3 (CHI), 99.7 (CCO_2Me), 52.1 (CH_3).

(E)-(((3-Iodoallyl)oxy)methyl)benzene **117**

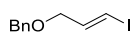

Prepared according to the literature procedure¹⁵² from **113** (8.01 g, 43.5 mmol) to give the title compound as a colourless oil (7.52 g, 27.4 mmol, 63%). Data corresponded to that reported in the literature;¹⁵² $\nu_{\max}/\text{cm}^{-1}$ 3150w, 1600 (C=C), 1240s, 1165s, 1080s (C–O); δ_{H} (400 MHz; CDCl_3) 7.40–7.30 (5H, m, $5 \times \text{ArH}$), 6.69 (1H, dt, $J = 14.5, 5.7$ Hz, CHCH_2OBn), 6.43 (1H, dt, $J = 14.5, 1.5$ Hz, CHI), 4.50 (2H, s, PhCH_2), 3.97 (2H, dd, $J = 5.7, 1.5$ Hz, BnOCH_2); δ_{C} (100 MHz; CDCl_3) 142.5 ($2 \times \text{CH}$), 137.9 (ArC_{quat}), 128.5 (ArCH), 127.9 (ArCH), 127.8 (ArCH), 78.9 (CHI), 72.4 (PhCH_2), 71.9 (BnOCH_2).

(E)-(2-(2-iodocyclopropyl)methoxy)methyl)benzene 98

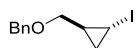

Prepared according to the literature procedure¹⁴⁰ from **117** (0.798 g, 1.81 mmol, 62%). Data corresponded to that reported in the literature;¹⁴⁰ $\nu_{\max}/\text{cm}^{-1}$ 3018w, 2853w, 1496s, 1452m, 1251s, 1212m, 1093s, 1076 (C–O), 1039s; δ_{H} (400 MHz; CDCl_3) 7.39–7.28 (5H, m, $5 \times \text{ArH}$), 4.56 (1H, d, $J = 12.1$ Hz, $\text{PhCH}(\text{H})$), 4.52 (1H, d, $J = 12.1$ Hz, $\text{PhCH}(\text{H})$), 3.48 (1H, dd, $J = 10.5, 6.1$ Hz, $\text{BnOCH}(\text{H})$), 3.37 (1H, dd, $J = 10.5, 6.6$ Hz, $\text{BnOCH}(\text{H})$), 2.27 (1H, ddd, $J = 9.3, 5.3, 3.9$ Hz, CHI), 1.58–1.50 (1H, m, BnOCH_2CH), 1.05–0.98 (cpr CH_2); δ_{C} (100 MHz; CDCl_3) 138.2 (ArC_{quat}), 128.5 (ArCH), 127.8 (ArCH), 127.7 (ArCH), 72.7 (PhCH_2), 71.6 (BnOCH_2), 23.1 (BnOCH_2CH), 14.7 (cpr CH_2), –17.5 (CHI).

(E)-(2-((benzyloxy)methyl)cyclopropyl)benzene 122

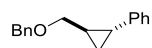

Prepared according to the literature procedure¹⁴⁰ from **98** (0.288 g, 1.00 mmol) to give the title compound as a colourless oil (0.166 g, 0.699 mmol, 70%). Data corresponded to that reported in the literature;¹⁴⁰ $\nu_{\max}/\text{cm}^{-1}$ 3050w, 3035w, 2854w, 1603s, 1499s, 1454s, 1358m, 1094s (C–O), 1072s; δ_{H} (400 MHz; CDCl_3) 7.33–7.19 (7H, m, $7 \times \text{ArH}$), 7.12–7.08 (1H, m, ArH), 7.04–7.02 (2H, m, $2 \times \text{ArH}$), 4.52 (2H, s, PhCH_2), 3.51 (1H, dd, $J = 10.3, 6.5$ Hz, $\text{BnOCH}(\text{H})$), 3.41 (1H, dd, $J = 10.3, 6.8$ Hz, $\text{BnOCH}(\text{H})$), 1.79–1.75 (1H, m, PhCH), 1.46–1.38 (1H, m, BnOCH_2CH), 0.97–0.87 (cpr CH_2); δ_{C} (100 MHz; CDCl_3) 142.8 (ArC_{quat}), 138.6 (ArC_{quat}), 128.5 (ArH), 128.4 (ArCH), 127.8 (ArCH), 127.7 (ArCH), 126.0 (ArCH), 125.7 (ArCH), 73.7 (BnOCH_2), 72.7 (PhCH_2), 22.7 (BnOCH_2CH), 21.6 (PhCH), 14.3 (cpr CH_2).

4-Methyl-2'-nitrobiphenyl 123

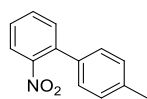

Prepared according to the literature procedure¹⁵¹ from 4-bromotoluene (0.171 g, 1.00 mmol), 2-nitrobenzoic acid (0.251 g, 1.50 mmol), $\text{Pd}(\text{acac})_2$ (3.04 mg, 0.010 mmol), CuI (1.90 mg, 0.03 mmol), 1,10-phenanthroline (9.01 mg, 0.05 mmol), K_2CO_3 (0.166 g, 1.2 mmol), 3 Å mol. sieves (250 mg) at 160 °C in NMP (1.50 mL) for 24 h to

give the title compound as a colourless oil (0.202 g, 0.95 mmol, 95%). Data corresponded to that reported in the literature;¹⁸⁶ $\nu_{\text{max}}/\text{cm}^{-1}$ 3033w, 2921w, 1614m, 1566m, 1522 (N- $\dot{\text{O}}$), 1476, 1353 (N-O), 1041; δ_{H} (400 MHz; CDCl_3) 7.86–7.84 (1H, m, CH_{Ar}), 7.64–7.62 (1H, m, CH_{Ar}), 7.50–7.45 (2H, m, $2 \times \text{CH}_{\text{Ar}}$), 7.28–7.24 (4H, m, $4 \times \text{CH}_{\text{Ar}}$), 2.43 (3H, s, CH_3); δ_{C} (100 MHz; CDCl_3) 149.5 (ArC_{quat}), 138.3 (ArC_{quat}), 136.4 (ArC_{quat}), 134.7 (ArCH), 134.5 (ArC_{quat}), 132.0 (ArCH), 129.5 (ArCH), 128.0 (ArCH), 127.9 (ArCH), 124.1 (ArCH), 21.3 (CH_3).

References

- ¹ (a) A. Freund, *J. Prakt. Chem.*, 1981, **26**, 368–377; (b) J. B. Conant in *The Chemistry of Heterocycles*, ed. Z. Rappoport, John Wiley & Sons, 1st edn., 1995, vol. 2.
- ² M. Kato, V. P. Kamat, Y. Tooyama and A. Yoshikoshi, *J. Org. Chem.*, 1989, **54**, 1536–1538.
- ³ H. N. C. Wong, M.-Y. Hon, C.-W. Tse and Y.-C. Yip, *Chem. Rev.*, 1989, **89**, 165–198.
- ⁴ A. D. Walsh, *Trans. Faraday Soc.* 1949, **45**, 179–190.
- ⁵ M. J. S. Dewar, *J. Am. Chem. Soc.* 1984, **106**, 669–682.
- ⁶ D. Moran, M. Manoharan, T. Heine and P. v. R. Schleyer, *Org. Lett.*, 2003, **5**, 23–26.
- ⁷ W. Wu, B. Ma, J. I.-C. Wu, P. v. R. Schleyer and Y. Mo, *Chem. Eur. J.*, 2009, **15**, 9730–9736.
- ⁸ K. Exner and P. v. R. Schleyer, *J. Phys. Chem. A*, 2001, **105**, 3407–3416.
- ⁹ D. Cremer and E. Kraka, *J. Am. Chem. Soc.*, 1985, **107**, 3800–3810.
- ¹⁰ For some examples of contradictory evidence see: (a) S. Inagaki, N. Goto and K. Yoshikawa, *J. Am. Chem. Soc.*, 1991, **113**, 7144–7146; (b) P. B. Karadakov, J. Gerratt, D. L. Cooper and M. Raimondi, *J. Am. Chem. Soc.*, 1994, **116**, 7714–7721.
- ¹¹ K. B. Wiberg, *Acc. Chem. Res.* 1996, **29**, 229–234
- ¹² M. Baranac-Stojanović and M. Stojanović, *J. Org. Chem.*, 2013, **78**, 1504–1507.
- ¹³ T. Eicher, S. Hauptmann and A. Speicher in *The Chemistry of Heterocycles*, John Wiley & Sons, 1995.
- ¹⁴ A. C. Legon, *Chem. Rev.*, 1980, **80**, 231–262.
- ¹⁵ W. H. Perkin, *Chem. Ber.*, 1884, **17**, 323–325.
- ¹⁶ W. von E. Doering and A. K. Hoffmann, *J. Am. Chem. Soc.*, 1954, **76**, 6162–6165.
- ¹⁷ H. E. Simmons and R. D. Smith, *J. Am. Chem. Soc.*, 1958, **80**, 5323–5324.
- ¹⁸ G. Stork and J. Ficini, *J. Am. Chem. Soc.*, 1961, **83**, 4678–4678.
- ¹⁹ E. J. Corey and M. Chaykovsky, *J. Am. Chem. Soc.*, 1965, **87**, 1353–1364.

- ²⁰ S. Xu, K. Itto, M. Satoh and H. Arimoto, *Chem. Commun.*, 2014, **50**, 2758–2761.
- ²¹ P. Mauleón, J. L. Krinsky and F. D. Toste, *J. Am. Chem. Soc.*, 2009, **131**, 4513–4520.
- ²² B. Martel and J. M. Hiriart, *Synthesis*, 1972, 201–202.
- ²³ S. Chandrasekhar, Ch. Narasimulu, V. Jagadeshwar and K. V. Reddy, *Tetrahedron Lett.*, 2003, **44**, 3629–3630.
- ²⁴ C. D. Bray and G. de Faveri, *J. Org. Chem.*, 2010, **75**, 4652–4655.
- ²⁵ D. B. Denney and M. J. Boskin, *J. Am. Chem. Soc.*, 1959, **81**, 6330–6331.
- ²⁶ I. Peretto, S. Radaelli, C. Parini, M. Zandi, L. F. Raveglia, G. Dondio, L. Fontanella, P. Misiano, C. Bigogno, A. Rizzi, B. Riccardi, M. Biscaioli, S. Marchetti, P. Puccini, S. Catinella, I. Rondelli, V. Cenacchi, P. T. Bolzoni, P. Caruso, G. Villetti, F. Facchinetti, E. Del Giudice, N. Moretto and B. P. Imbimbo, *J. Med. Chem.*, 2005, **48**, 5705–5720.
- ²⁷ H. Lebel, J.-F. Marcoux, C. Molinaro and A. B. Charette, *Chem. Rev.*, 2003, **103**, 977–1050.
- ²⁸ K. F. Morgan, I. A. Hollingsworth and J. A. Bull, *Chem. Commun.*, 2014, **50**, 5203–5205.
- ²⁹ K. Okuma, Y. Tanaka, S. Kaji and H. Ohta, *J. Org. Chem.*, 1983, **48**, 5133–5134.
- ³⁰ X. Pannecoucke, F. Outurquin and C. Paulmier, *Eur. J. Org. Chem.*, 2002, 995–1006.
- ³¹ F. Vogt, K. Jodicke, J. Schröder and T. Bach, *Synthesis*, 2009, 4268–4273.
- ³² A. G. Griesbeck and H. Heckroth, *J. Am. Chem. Soc.*, 2002, **124**, 396–403.
- ³³ S. Searles, Jr., H. R. Hays and E. F. Lutz, *J. Org. Chem.*, 1962, **27**, 2828–2832.
- ³⁴ (a) R. Faust, *Angew. Chem. Int. Ed.*, 2001, **40**, 2251–2253; (b) K. A. Kumar, *Int. J. Pharm. Pharm. Sci.*, 2013, **5**, 467–472.
- ³⁵ (a) J. Salaiün and M. S. Baird in *Current Medicinal Chemistry*, ed. A.-ur-Rahman, Bentham Science Publishers, 1995, vol. 2; (b) H. R. Moon, H. O. Kim, M. W. Chun, L. S. Jeong and V. E. Marquez, *J. Org. Chem.*, 1999, **64**, 4733–4741; (c) H. S. Kim, D. Barak, T. K. Harden, J. L. Boyer and K. A. Jacobsen, *J. Med. Chem.*, 2001, **44**, 3092–3108.

- ³⁶ D. L. Boger and D. S. Johnson, *Proc. Natl. Acad. Sci. USA*, 1995, **92**, 3642–3649.
- ³⁷ (a) H. Dalton, B. T. Golding, B. W. Waters, R. Higgins and J. A. Taylor, *J. Chem. Soc. Chem. Comm.*, 1981, 482–483; (b) A. M. Valentine, M.-H. LeTadic-Biadatti, P. H. Toy, M. Newcomb and S. J. Lippard, *J. Biol. Chem.*, 1999, **274**, 10771–10776.
- ³⁸ (a) A. R. Pinder, *Nat. Prod. Rep.*, 1992, **9**, 491–504; (b) J. A. Burkhard, G. Wuitschik, M. Rogers-Evans, K. Müller and E. M. Carreira, *Angew. Chem. Int. Ed.*, 2010, **49**, 9052–9067.
- ³⁹(a) G. Wuitschik, M. Rogers-Evans, K. Müller, H. Fischer, B. Wagner, F. Schuler, L. Polonchuk and E. M. Carreira, *Angew. Chem. Int. Ed.*, 2006, **45**, 7736–7739; (b) G. Wuitschik, M. Rogers-Evans, A. Buckl, M. Bernasconi, M. Märki, T. Godel, H. Fischer, B. Wagner, I. Parrilla, F. Schuler, J. Schneider, A. Alker, W. B. Schweizer, K. Müller and E. M. Carreira, *Angew. Chem. Int. Ed.*, 2008, **47**, 4512–4515; (c) J. A. Burkhard, G. Wuitschik, M. Rogers-Evans, K. Müller and E. M. Carreira, *Angew. Chem. Int. Ed.*, 2010, **49**, 9052–9067; (d) G. Wuitschik, E. M. Carreira, B. Wagner, H. Fischer, I. Parrilla, F. Schuler, M. Rogers-Evans and K. Müller, *J. Med. Chem.*, 2010, **53**, 3227–3246; (e) J. A. Burkhard, B. Wagner, H. Fischer, F. Schuler, K. Müller and E. M. Carreira, *Angew. Chem. Int. Ed.*, 2010, **49**, 3524–3527; (f) A. F. Stepan, K. Karki, W. S. McDonald, P. H. Dorff, J. K. Dutra, K. J. DiRico, A. Won, C. Subramanyam, I. V. Efremov, C. J. O'Donnell, C. E. Nolan, S. L. Becker, L. R. Pustilnik, B. Sneed, H. Sun, Y. Lu, A. E. Robshaw, D. Riddell, T. J. O'Sullivan, E. Sibley, S. Capetta, K. Atchison, A. J. Hallgren, E. Miller, A. Wood and R. S. Obach, *J. Med. Chem.*, 2011, **54**, 7772–7783; (g) J. A. Burkhard, C. Guérot, H. Knust and E. M. Carreira, *Org. Lett.*, 2012, **14**, 66–69.
- ⁴⁰ J. C. Namyslo and D. E. Kaufmann, *Chem. Rev.*, 2003, **103**, 1485–1537.
- ⁴¹ C. Sparr and R. Gilmour, *Angew. Chem. Int. Ed.*, 2011, **50**, 8391–8395.
- ⁴²(a) B. J. Fitzsimmons and B. Fraser-Reid, *Tetrahedron*, 1984, **40**, 1279–1287; (b) R. C. Petter, *Tetrahedron Lett.*, 1989, **30**, 399–402; (c) R. C. Petter, S. Banerjee and S. Englard, *J. Org. Chem.*, 1990, **55**, 3088–3097; (d) T. E. Jacks, H. Nibbe and D. F. Wiemer, *J. Org. Chem.*, 1993, **58**, 4584–4588; (e) J. A. Robl, E. Sieber-McMaster and R. Sulsky, *Tetrahedron Lett.*, 1996, **37**, 8985–8988; (f) V.

Padmavathi, K. Sharmila, A. S. Reddy, D. B. Reddy, *Indian J. Chem., Sect. B: Org. Chem. Incl. Med. Chem.*, 2001, **40**, 11–14; (g) A. K. Singh, M. N. Rao, J. H. Simpson, W-S Li, J. E. Thornton, D. E. Kuehner and D. J. Kacsur, *Org. Process Res. Dev.*, 2002, **6**, 618–620; (h) A. Armstrong and J. N. Scutt, *Org. Lett.*, 2003, **5**, 2331–2334; (i) A. Armstrong and J. N. Scutt, *Chem. Commun.*, 2004, 510–511; (j) L. Delhaye, A. Merschaert, P. Delbeke and W. Briône, *Org. Process Res. Dev.*, 2007, **11**, 689–692.

⁴³ W. S. Wadsworth and W. D. Emmons, *J. Am. Chem. Soc.*, 1961, **83**, 1733–1738.

⁴⁴ D. B. Denney, J. J. Vill and M. J. Boskin, *J. Am. Chem. Soc.*, 1962, **84**, 3944–3946.

⁴⁵ (a) W. E. McEwen, A. Bladé-Font and C. A. VanderWerf, *J. Am. Chem. Soc.*, 1962, **84**, 677–679; (b) W. E. McEwen and A. P. Wolf, *J. Am. Chem. Soc.*, 1962, **84**, 676–677.

⁴⁶ (a) I. Tomoskozi, *Tetrahedron*, 1963, **19**, 1969–1979; (b) Y. Inouye, T. Sugita and H. M. Walborsky, *Tetrahedron*, 1964, **20**, 1695–1699.

⁴⁷ R. A. Izydore and R. G. Ghirardelli, *J. Org. Chem.*, 1973, **38**, 1790–1793.

⁴⁸ H. Krawczyk, K. Wasek, J. Kedzia, J. Wojciechowski, W. M. Wolf, *Org. Biomol. Chem.*, 2008, **6**, 308–318.

⁴⁹ S. K. Thompson and C. H. Heathcote, *J. Org. Chem.*, 1990, **55**, 3386–3388.

⁵⁰ F. Minicone, Ph.D. Thesis, Queen Mary University of London, 2014.

⁵¹ W. A. Bone and W. H. Perkin, *J. Chem. Soc. Trans.*, 1895, **67**, 108–119.

⁵² For selected examples see: (a) J. M. Stewart and H. H. Westberg, *J. Org. Chem.*, 1965, **30**, 1951–1955; (b) S. Danishefsky, J. Dynak, E. Hatch and M. Yamamoto, *J. Am. Chem. Soc.*, 1974, **96**, 1256–1259; (c) P. L. Fuchs, *J. Am. Chem. Soc.*, 1974, **96**, 1607–1609; (d) S. Danishefsky and R. K. Singh, *J. Am. Chem. Soc.*, 1975, **97**, 3239–3241; (e) S. Danishefsky, *Acc. Chem. Res.*, 1979, **12**, 66–72; (f) P. Kocienski and C. Yeates, *J. Chem. Soc., Chem. Commun.*, 1984, 151–152; (g) R. P. Wurz and A. B. Charette, *Org. Lett.*, 2005, **7**, 2313–2316; (h) L. Lu, G. Chen and S. Ma, *Org. Lett.*, 2006, **8**, 835–838; (i) K. Wang, D. Xiang, J. Y. Liu, W. Pan and D. Dong, *Org. Lett.* 2008, **10**, 1691–1694; (j) D. Du and Z. Wang, *Tetrahedron Lett.*, 2008, **49**, 956–959.

⁵³ For selected examples see: (a) W. S. Murphy and S. Wattanasin, *J. Chem. Soc., Perkin Trans. 1*, 1981, 2920–2926; (b) W. S. Murphy and S. Wattanasin, *J. Chem. Soc., Perkin Trans. 1*, 1982, 1029–1035; (c) R. K. Dieter and S. Pounds, *J. Org. Chem.*, 1982, **47**, 3174–3177; (d) P. Langer and G. Bose, *Angew. Chem., Int. Ed.*, 2003, **42**, 4033–4036; (e) Y.-H. Yang and M. Shi, *J. Org. Chem.*, 2005, **70**, 10082–10085; (f) Y.-H. Yang and M. Shi, *Eur. J. Org. Chem.*, 2006, 5394–5403; (g) Y.-H. Yang, Y.-H. Liu and M. Shi, *Org. Biomol. Chem.*, 2006, **4**, 4131–4134; (h) Y.-H. Yang and M. Shi, *Org. Lett.*, 2006, **8**, 1709–1712; (i) X. Huang, W. Fu and M. Miao, *Tetrahedron Lett.*, 2008, **49**, 2359–2362; (j) V. K. Yadav and N. V. Kumar, *Chem. Commun.*, 2008, 3774–3776; (k) B. Hu, S. Y. Xing and Z. W. Wang, *Org. Lett.* 2008, **10**, 5481–5484; (l) Q. Fu and C.-G. Yan, *Tetrahedron Lett.*, 2011, **52**, 4497–4500; (m) Y. Han, Q. Fu, W. Tang and C. Yan, *Chin. J. Chem.*, 2012, **30**, 1867–1872; (n) C. M. Braun, A. M. Shema, C. C. Dulin and K. A. Nolin, *Tetrahedron Lett.* 2013, **54**, 5889–5891.

⁵⁴ M. Yu and B. L. Pagenkopf, *Tetrahedron*, 2005, **61**, 321–347

⁵⁵ Z. Han, S. Uehira, T. Tsuritani, H. Shinokubo and K. Oshima, *Tetrahedron*, 2001, **57**, 987–995.

⁵⁶ P. Yates, P. H. Helferty, P. Mahler, *Can. J. Chem.*, 1983, **61**, 78–85.

⁵⁷ W. E. Truce and L. B. Lindy, *J. Org. Chem.*, 1961, **27**, 1463–1467.

⁵⁸ A. B. Smith, III and R. M. Scarborough, Jr., *Tetrahedron Lett.*, 1978, **19**, 1649–1652.

⁵⁹ E. J. Enholm and Z. J. Jia, *J. Org. Chem.*, 1997, **62**, 5248–5249.

⁶⁰ C. P. Casey and M. C. Cesa, *J. Am. Chem. Soc.*, 1979, **101**, 4236–4244.

⁶¹ (a) S. Ogoshi, M. Nagata and H. Kurosawa, *J. Am. Chem. Soc.*, 2006, **128**, 5350–5351; (b) L. Liu and J. Montgomery, *J. Am. Chem. Soc.*, 2006, **128**, 5348–5349.

⁶² D. V. Avilov, M. G. Malusare, E. Arslançan and D. C. Dittmer, *Org. Lett.*, 2004, **6**, 2225–2228.

⁶³ For selected examples see: (a) L. Pellacani, P. A. Tardella and M. A. Loreto, *J. Org. Chem.*, 1976, **41**, 1282–1283; (b) R. A. Batey, J. D. Harling, W. B. Motherwell, *Tetrahedron*, 1996, **52**, 11421–11444; (c) Y.-H. Lim, K. F. McGee, S. McN. Sieburth, *J. Org. Chem.*, 2002, **67**, 6535–6538; (d) X. Jiang, Z. Lim and Y.-Y. Yeung, *Tetrahedron Lett.*, 2013, **54**, 1798–1801.

- ⁶⁴ (a) R. K. Boeckman, Jr., P. F. Jackson and J. P. Sabatucci, *J. Am. Chem. Soc.*, 1985, **107**, 2191–2192; (b) R. K. Boeckman, Jr., J. P. Sabatucci, S. W. Goldstein, D. M. Springer and P. F. Jackson, *J. Org. Chem.*, 1986, **51**, 3740–3742.
- ⁶⁵ L. Li, Z. Li and Q. Wang, *Synlett*, 2009, **11**, 1830–1834.
- ⁶⁶ G. Lelais and D. W. C. MacMillan, *Aldrichimica Acta*, 2006, **39** (3), 79–87.
- ⁶⁷ B. List, R. A. Lerner, C. F. Barbas, III, *J. Am. Chem. Soc.*, 2000, **122**, 2395–2396.
- ⁶⁸ K. A. Ahrendt, C. J. Borths, D. W. C. MacMillan, *J. Am. Chem. Soc.*, 2000, **122**, 4243–4244.
- ⁶⁹ For reviews see: (a) A. Erkkilä, I. Majander and P. M. Pihko, *Chem. Rev.*, 2007, **107**, 5416–5470; (b) D. Almasi, D. A. Alonso and C. Nájera, *Tetrahedron: Asymmetry*, 2007, **18**, 299–365; (c) M. J. Gaunt, C. C. C. Johansson, A. McNally and N. T. Vo, *Drug Discovery Today*, 2007, **12**, 8–27; (d) A. Dondoni and A. Massi, *Angew. Chem. Int. Ed.*, 2008, **47**, 4638–4660; (e) P. Melchiorre, M. Marigo, A. Carlone, and G. Bartoli, *Angew. Chem. Int. Ed.*, 2008, **47**, 6138–6171; (f) V. Terrasson, R. M. de Figueiredo and J. M. Campagne, *Eur. J. Org. Chem.*, 2010, 2635–2655; (g) P. Chauhan and S. S. Chimni, *RSC Advances*, 2012, **2**, 6117–6134.
- ⁷⁰ (a) M. Bruvoll, T. Hansen and E. Uggerud, *J. Phys. Org. Chem*, 2007, **20**, 206–213; (b) U. Grošelj, W. B. Schweizer, M.-O. Ebert and D. Seebach, *Helv. Chim. Acta*, 2009, **92**, 1–13.
- ⁷¹ Z. Lili, Z. Zhongjun, J. Haiyang, L. Huiling and H. Xuri, *Tetrahedron: Asymmetry*, 2013, **24**, 1–6.
- ⁷² I. Fleischer and A. Pfaltz, *Chem. Eur. J.*, 2010, **16**, 95–99.
- ⁷³ S. Lakhdar and H. Mayr, *Chem. Commun.*, 2011, **47**, 1866–1868.
- ⁷⁴ N. A. Paras and D. W. C. MacMillan, *J. Am. Chem. Soc.*, 2001, **123**, 4370–4371.
- ⁷⁵ C. Allemann, R. Gordillo, F. R. Clemente, P. H.-Y. Cheong and K. N. Houk, *Acc. Chem. Res.*, 2004, **37**, 558–569.
- ⁷⁶ J. B. Brazier, G. Evans, T. J. K. Gibbs, S. J. Coles, M. B. Hursthouse, J. A. Platts and N. C. O. Tomkinson, *Org. Lett.*, 2009, **11**, 133–136.
- ⁷⁷ D. Seebach, U. Grošelj, D. M. Badine, W. B. Schweizer and A. K. Beck, *Helv. Chim. Acta*, 2008, **91**, 1999–2034.

- ⁷⁸ S. Lakhdar, T. Tokuyasu and H. Mayr, *Angew. Chem. Int. Ed.*, 2008, **47**, 8723–8726.
- ⁷⁹ D. Seebach, U. Grošelj, W. B. Schweizer, S. Grimme and C. Mück-Lichtenfeld, *Helv. Chim. Acta*, 2010, **93**, 1–16.
- ⁸⁰ C. Sparr and R. Gilmour, *Angew. Chem. Int. Ed.*, 2010, **49**, 6520–6523.
- ⁸¹ J. Blacker, L. A. Clutterbuck, M. R. Crampton, C. Grosjean and M. North, *Tetrahedron: Asymmetry*, 2006, **17**, 1449–1456.
- ⁸² (a) N. A. Paras and D. W. C. MacMillan, *J. Am. Chem. Soc.*, 2002, **124**, 7894–7895; (b) J. F. Austin and D. W. C. MacMillan, *J. Am. Chem. Soc.*, 2002, **124**, 1172–1173; (c) S. P. Brown, N. C. Goodwin and D. W. C. MacMillan, *J. Am. Chem. Soc.*, 2003, **125**, 1192–1194; (d) S. G. Ouellet, J. B. Tuttle and D. W. C. MacMillan, *J. Am. Chem. Soc.*, 2005, **127**, 32–33.
- ⁸³ (a) C. Gueguen, P. O'Brien, H. R. Powell, P. R. Raithby, S. Warren, *J. Chem. Soc., Perkin Trans. 1*, 1998, **20**, 3405–3418; (b) M. Ono, S. Tanikawa, K. Suzuki, H. Akita, *Tetrahedron*, 2004, **60**, 10187–10195; (c) K. Kubota, E. Yamamoto, H. Ito, *J. Am. Chem. Soc.*, 2013, **135**, 2635–2640; (d) D. Polet, X. Rathgeb, C. A. Falcicola, J.-B. Langlois, S. El Hajjaji, A. Alexakis, *Chem. Eur. J.*, 2009, **15**, 1205–1216.
- ⁸⁴ H. Mayr Mayr's Database of Reactivity Parameters *Ludwig-Maximilians Universität München* [Online] <http://www.cup.lmu.de/oc/mayr/reaktionsdatenbank/> (accessed April, 2011).
- ⁸⁵ Prepared according to a modified literature procedure: H. Helmboldt, D. Köhler and M. Hiersemann, *Org. Lett.*, 2006, **8**, 1573–1576.
- ⁸⁶ M. Mikołajczyk, S. Grzejszczak, A. Chęczyńska and A. Zatorski, *J. Org. Chem.*, 1979, **44**, 2967–2972.
- ⁸⁷ A. Kunfermann, C. Lienau, B. Illarionov, J. Held, T. Gräwert, C. T. Behrendt, P. Werner, S. Hähn, W. Eisenreich, U. Riederer, B. Mordmüller, A. Bacher, M. Fischer, M. Groll and T. Kurz, *J. Med. Chem.*, 2013, **56**, 8151–8162.
- ⁸⁸ K. Okuma, Y. Tachibana, J.-i. Sakata, T. Komiya, I. Kaneko, Y. Komiya, I. Kaneko, Y. Komiya, Y. Yamasaki, S.-i. Yamamoto and H. Ohta, *Bull. Chem. Soc. Jpn.*, 1988, **61**, 4323–4327.
- ⁸⁹ Prepared by the procedure described in: S. Y. Chow, H. J. Williams, Q. Huang, S. Nanda and A. I. Scott, *J. Org. Chem.*, 2005, **70**, 9997–10003.

- ⁹⁰ (a) D. J. Mack, L. A. Batory and J. T. Njardarson, *Org. Lett.*, 2012, **14**, 378–381; (b) A. R. Howell and A. J. Ndakala, *Org. Lett.*, 1999, **1**, 825–827; (c) H. Ruotsalainen and T. Kärki, *Acta Chem. Scand.*, 1983, **37b**, 151–154.
- ⁹¹ R. Paulissen, H. Reimlinger, E. Hayez, A. J. Hubert and Ph. Teyssié, *Tetrahedron Lett.*, 1973, **14**, 2233–2236.
- ⁹² Prepared according to the procedure described in: J. C. Griffith, K. M. Jones, S. Picon, M. J. Rawling, B. M. Kariuki, M. Campbell and N. C. O. Tomkinson, *J. Am. Chem. Soc.*, 2010, **132**, 14409–14411
- ⁹³ B. Kaboudin and M. Sorbiun, *Heteroat. Chem.*, 2010, **21**, 284–289.
- ⁹⁴ For a review see: R. G. Johnson and R. K. Ingham, *Chem. Rev.* 1956, **56**, 219–269.
- ⁹⁵ D. H. R. Barton, D. Crich and W. B. Motherwell, *J. Chem. Soc., Chem. Commun.* 1983, 939–941.
- ⁹⁶ W. H. Perkin, *J. Chem. Soc., Trans.* 1885, **47**, 801–854.
- ⁹⁷ For selected examples see: (a) S. F. Birch, W. H. Gough and G. A. R. Kon, *J. Chem. Soc., Trans.* 1921, **119**, 1315–1328; (b) C. F. H. Allen and H. W. J. Cressman, *J. Am. Chem. Soc.* 1933, **55**, 2953–2960; (c) F. H. Case, *J. Am. Chem. Soc.* 1934, **56**, 715–717; (d) H. H. Fox, J. T. Gibas, H. L. Lee and A. Boris, *J. Med. Chem.*, 1964, **7**, 790–792; (e) N. O. Brace, *J. Org. Chem.* 1975, **40**, 851–858; (f) P. E. O'Bannon and W. P. Dailey, *J. Org. Chem.* 1990, **55**, 353–355; (g) T. Połoński, M. J. Milewska and A. Katrusiak, *J. Org. Chem.* 1993, **58**, 3411–3415; (h) T. Yamada, F. Yoshimura and K. Tanino, *Tetrahedron Lett.* 2013, **54**, 522–525.
- ⁹⁸ A. Borodine, *Liebigs Ann. Chem.* 1861, **119**, 121–123.
- ⁹⁹ For selected examples see: (a) J. D. Roberts and V. C. Chambers, *J. Am. Chem. Soc.* 1951, **73**, 3176–3179; (b) J. S. Meek and D. T. Osuga, *Org. Synth.* 1963, **43**, 9–11; (c) L. A. Paquette, T. Uchida and J. C. Gallucci, *J. Am. Chem. Soc.* 1984, **106**, 335–340; (d) A. Al-Dulayymi, X. Li and M. Neuenschwander, *Helv. Chim. Acta* 2000, **83**, 571–582.
- ¹⁰⁰ For selected examples see: (a) Z. Hell and L. Tőke, *Synth. Commun.* 1996, **26**, 2127–2133; (b) M. Oba, N. Nishiyama and K. Nishiyama, *Tetrahedron* 2005, **61**, 8456–8464; (c) T. D. Avery, J. A. Culbert and D. K. Taylor, *Org. Biomol. Chem.* 2006, **4**, 323–330; (d) S. Yonezawa, T. Yamamoto, H. Yamakawa, C. Muto, M.

Hosono, K. Hattori, K. Higashino, T. Yutsudo, H. Iwamoto, Y. Kondo, M. Sakagami, H. Togame, Y. Tanaka, T. Nakano, H. Takemoto, M. Arisawa and S. Shuto, *J. Med. Chem.* 2012, **55**, 8838–8858; (e) R. Coyle, K. Fahey and F. Aldabbagh, *Org. Biomol. Chem.* 2013, **11**, 1672–1682.

¹⁰¹ (a) P. Dyson and D. Ll. Hammick, *J. Chem. Soc.*, 1937, 1724–1725; (b) M. R. F. Ashworth, R. P. Daffern and D. Ll. Hammick, *J. Chem. Soc.*, 1939, 809–812; (c) B. R. Brown and D. Ll. Hammick, *J. Chem. Soc.*, 1949, 173–176; (d) B. R. Brown and D. Ll. Hammick, *J. Chem. Soc.*, 1949, 659–663.

¹⁰² W. Von E. Doering and V. Z. Pasternak, *J. Am. Chem. Soc.*, 1950, **72**, 143–147.

¹⁰³ M. Nilsson, *Acta. Chem. Scand.*, 1966, **20**, 423–426.

¹⁰⁴ (a) M. Nilsson and C. Ullenius, *Acta Chem. Scand.*, 1968, **22**, 1998–2002; (b) C. Björklund and M. Nilsson, *Acta Chem. Scand.*, 1968, **22**, 2585–2588; (c) J. Chodowska-Palicka and M. Nilsson, *Acta Chem. Scand.*, 1970, **24**, 3353–3361.

¹⁰⁵ A. Cairncross, J. R. Roland, R. M. Henderson and W. A. Sheppard, *J. Am. Chem. Soc.*, 1970, **92**, 3187–3189.

¹⁰⁶ T. Cohen, R. W. Berninger and J. T. Wood, *J. Org. Chem.*, 1978, **43**, 837–848.

¹⁰⁷ T. Cohen and R. A. Schambach, *J. Am. Chem. Soc.*, 1970, **92**, 3189–3190.

¹⁰⁸ A. S. Lisitsyn, *Appl. Catal. A*, 2007, **332**, 166–170.

¹⁰⁹ L. J. Gooßen, W. R. Thiel, N. Rodríguez, C. Linder and B. Melzer, *Adv. Synth. Catal.*, 2007, **349**, 2241–2246; (b) L. J. Gooßen, N. Rodríguez, C. Linder, P. P. Lange and A. Fromm, *ChemCatChem*, 2010, **2**, 430–442.

¹¹⁰ L. J. Gooßen, G. Deng and L. M. Levy, *Science*, 2006, **313**, 662–664.

¹¹¹ L. J. Gooßen, C. Linder, N. Rodríguez, P. P. Lange and A. Fromm, *Chem. Commun.*, 2009, 7173–7175.

¹¹² (a) J. Cornella, C. Sanchez, D. Banawa and I. Larrosa, *Chem. Commun.*, 2009, 7176–7178; (b) P. Lu, C. Sanchez, J. Cornella and I. Larrosa, *Org. Lett.*, 2009, **11**, 5710–5713

¹¹³ L. Xue, W. Su and Z. Lin, *Dalton Trans.*, 2011, **40**, 11926–11936.

¹¹⁴ G. J. Quallich and P. M. Morrissey, *Synthesis*, 1993, 51–53.

¹¹⁵ S. R. Waetzig and J. A. Tunge, *J. Am. Chem. Soc.*, 2007, **129**, 4138–4139.

¹¹⁶ D. M. McKinnon, P. Spevack and G. Tipples, *Can. J. Chem.*, 1988, **66**, 2339–2344.

- ¹¹⁷ P. Müller and A. Ghanem, *Org. Lett.*, 2004, **6**, 4347–4350.
- ¹¹⁸ A. G. Myers, D. Tanaka and M. R. Mannion, *J. Am. Chem. Soc.*, 2002, **124**, 11250–11251.
- ¹¹⁹ D. Tanaka, S. P. Romeril and A. G. Myers, *J. Am. Chem. Soc.*, 2005, **127**, 10323–10333.
- ¹²⁰ P. Forgione, M.-C. Brochu, M. St-Onge, K. H. Thesen, M. D. Bailey and F. Bilodeau, *J. Am. Chem. Soc.*, 2006, **128**, 11350–11351.
- ¹²¹ For selected reviews see: (a) O. Baudoin, *Angew. Chem. Int. Ed.*, 2007, **46**, 1373–1375; (b) J. D. Weaver, A. Recio, III, A. J. Grenning and J. A. Tunge, *Chem. Rev.*, 2011, **111**, 1846–1913; (c) R. Shang and L. Liu, *Sci. China Chem.*, 2011, **54**, 1670–1687; (d) N. Rodríguez and L. J. Goossen, *Chem. Soc. Rev.* 2011, **40** 5030–5048; (e) W. I. Dzik, P. P. Lange and L. J. Gooßen, *Chem. Sci.*, 2012, **3**, 2671–2678; (f) K. Park and S. Lee, *RSC Adv.*, 2013, **3**, 14165–14182; (g) Z.-L. Wang, *Adv. Synth. Catal.*, 2013, **355**, 2745–2755.
- ¹²² R. Shang, Y. Fu, Y. Wang, Q. Xu, H.-Z. Yu and L. Liu, *Angew. Chem. Int. Ed.*, 2009, **48**, 9350–9354.
- ¹²³ J. M. Becht, C. Catala, C. L. Drian and A. Wagner, *Org. Lett.*, 2007, **9**, 1781–1783.
- ¹²⁴ P. Hu, Y. Shang and W. Su, *Angew. Chem. Int. Ed.*, 2012, **51**, 5945–5949.
- ¹²⁵ (a) S.-L. Zhang, Y. Fu, R. Shang, Q.-X. Guo and L. Liu, *J. Am. Chem. Soc.*, 2010, **132**, 638–646; (b) F. Svensson, R. S. Mane, J. Sävmarker, M. Larhed and C. Sköld, *Organometallics*, 2013, **32**, 490–497.
- ¹²⁶ (a) J. Zhou, P. Hu, M. Zhang, S. Huang, M. Wang and W. Su, *Chem. Eur. J.*, 2010, **16**, 5876–5881; (b) C. Wang, S. Rakshit and F. Glorius, *J. Am. Chem. Soc.*, 2010, **132**, 14006–14008.
- ¹²⁷ E.-i. Negishi in *Handbook of Organopalladium Chemistry for Organic Synthesis*, ed. E.-i. Negishi and A. de Meijere, John Wiley & Sons, 1st edn., 2003, vol.1 and vol. 2.
- ¹²⁸ H. Doucet, *Eur. J. Org. Chem.*, 2008, 2013–2030.
- ¹²⁹ (a) S.-M. Zhou, M.-Z. Deng, L.-J. Xia and M.-H. Tang, *Angew. Chem. Int. Ed.*, 1998, **37**, 2845–2847; (b) H. Chen and M.-Z. Deng, *Org. Lett.* 2000, **2**, 1649–1651; (c) H. Chen and M.-Z. Deng, *J. Chem. Soc., Perkin Trans. 1*, 2000, 1609–1613; (d) M.-L. Yao and M.-Z. Deng, *New J. Chem.*, 2000, **24**, 425–428;

- (e) H. Chen and M.-Z. Deng, *J. Org. Chem.* 2000, **65**, 4444–4446; (f) J. Pietruszka, A. Witt and W. Frey, *Eur. J. Org. Chem.* 2003, 3219–3229; (g) G.-H. Fang, Z.-J. Yan and M.-Z. Deng, *Org. Lett.*, 2004, **6**, 357–360; (h) M. A. J. Duncton and R. Singh, *Org. Lett.*, 2013, **15**, 4284–4287.
- ¹³⁰ (a) M.-L. Yao and M.-Z. Deng, *J. Org. Chem.*, 2000, **65**, 5034–5036; (b) D. J. Wallace and C.-y. Chen, *Tetrahedron Lett.*, 2002, **43**, 6987–6990.
- ¹³¹ M.-L. Yao and M.-Z. Deng, *Heteroat. Chem.*, 2000, **6**, 380–382.
- ¹³² (a) J. E. A. Luithle and J. Pietruszka, *J. Org. Chem.*, 1999, **64**, 8287–8797; (b) J. A. Soderquist, R. Huertas and G. Leon-Colon, *Tetrahedron Lett.*, 2000, **41**, 4251–4255; (c) G. A. Molander and P. E. Gormisky, *J. Org. Chem.*, 2008, **73**, 7481–7485; (d) E. Hohn, J. Paleček, J. Pietruszka and W. Frey, *Eur. J. Org. Chem.*, 2009, 3765–3782; (e) D. M. Knapp, E. P. Gillis and M. D. Burke, *J. Am. Chem. Soc.*, 2009, **131**, 6961–6963; (f) G. A. Molander, F. Beaumard and T. K. Niethamer, *J. Org. Chem.*, 2011, **76**, 8126–8130; (g) V. Colombel, F. Rombouts, D. Oehlich and G. A. Molander, *J. Org. Chem.*, 2012, **77**, 2966–2970.
- ¹³³ A. De Meijere, A. F. Khlebnikov, H. W. Sünemann, D. Frank, K. Rauch and D. S. Yufit, *Eur. J. Org. Chem.*, 2010, 3295–3301.
- ¹³⁴ (a) D. K. P. Ng and T.-Y. Luh, *J. Am. Chem. Soc.*, 1989, **111**, 9119–9121; (b) C. A. Ogle, K. C. Black and P. F. Sims, *J. Org. Chem.*, 1992, **57**, 3499–3503; (c) C. C. Yu, D. K. P. Ng, B.-L. Chen and T.-Y. Luh, *Organometallics*, 1994, **13**, 1487–1497; (d) R. C. Durley, M. L. Grapperhaus, B. S. Hickory, M. A. Massa, J. L. Wang, D. P. Spangler, D. A. Mischke, B. L. Parnas, Y. M. Fobian, N. P. Rath, D. D. Honda, M. Zeng, D. T. Connolly, D. M. Heuvelman, B. J. Witherbee, M. A. Melton, K. C. Glenn, E. S. Krul, M. E. Smith and J. A. Sikorski, *J. Med. Chem.*, 2002, **45**, 3891–3904; (e) V. A. Vu, I. Marek, K. Polborn and P. Knochel, *Angew. Chem. Int. Ed.*, 2002, **41**, 351–352; (f) J. A. Miller and J. W. Dankwardt, *Tetrahedron Lett.*, 2003, **44**, 1907–1910; (g) C. Shu, K. Sidhu, L. Zhang, X.-j. Wang, D. Krishnamurthy and C. H. Senanayake, *J. Org. Chem.*, 2010, **75**, 6677–6680; (h) S. Kolczewski and E. Pinard, *US Pat.*, 005 3904, 2011; (i) S. Malhotra, P. S. Seng, S. G. Koenig, A. J. Deese and K. A. Ford, *Org. Lett.*, 2013, **15**, 3698–3701; (j) S. Grupe and A. J. von Wangelin, *ChemCatChem*, 2013, **5**, 706–710.
- ¹³⁵ (a) S. F. Martin and M. P. Dwyer, *Tetrahedron Lett.*, 1998, **39**, 1521–1524; (b) K. Yachi, H. Shinokubo and K. Oshima, *Angew. Chem. Int. Ed.*, 1998, **37**, 2515–

2517; (c) A. Carpita, A. Ribecai, R. Rossi and P. Stabile, *Tetrahedron*, 2002, **58**, 3673–3680; (d) S. Cai, M. Dimitroff, T. McKennon, M. Reider, L. Robarge, D. Ryckman, X. Shang and J. Therrien, *Org. Process Res. Dev.*, 2004, **8**, 353–359; (e) P. Bonneau, P. Deroy, A. Gagnon, J. O’Meara, B. Simoneau and C. Yoakim, *US Pat.*, 006 9261, 2006; (f) A. E. A. Hassan, R. A. I. Abou-Elkhair, J. M. Riordan, P. W. Allan, W. B. Parker, R. Khare, W. R. Waud, J. A. Montgomery and J. A. Secrist, III, *Eur. J. Med. Chem.*, 2012, **47**, 167–174.

¹³⁶ (a) W. D. Schmitz and D. Romo, *Tetrahedron Lett.*, 1996, **37**, 4857–4860; (b) J. R. Falck, B. Mekonnen, J. Yu and J.-Y. Lai, *J. Am. Chem. Soc.*, 1996, **118**, 6096–6097; (c) M. Rubina and V. Gevorgyan, *Tetrahedron*, 2004, **60**, 3129–3159; (d) S. Wiedemann, K. Rauch, A. Savchenko, I. Marek and A. de Meijere, *Eur. J. Org. Chem.*, 2004, 631–635; (e) N. Heurreux, M. Marchant, N. Maulide, G. Berthon-Gelloz, C. Hermans, S. Hermant, E. Kiss, B. Leroy, P. Wasnaire and I. E. Markó, *Tetrahedron Lett.*, 2005, **46**, 79–83.

¹³⁷ L.-P. B. Beaulieu, L. B. Delvos and A. B. Charette, *Org. Lett.*, 2010, **12**, 1348–1351.

¹³⁸ A. Gagnon, M. Duplessis, P. Alsabeh and F. Barabé, *J. Org. Chem.*, 2008, **73**, 3604–3607.

¹³⁹ (a) I. Pérez, J. Pérez Sestelo and L. A. Sarandeses, *Org. Lett.*, 1999, **1**, 1267–1269; (b) I. Pérez, J. Pérez Sestelo and L. A. Sarandeses, *J. Am. Chem. Soc.*, 2001, **123**, 4155–4160.

¹⁴⁰ A. B. Charette and A. Giroux, *J. Org. Chem.*, 1996, **61**, 8718–8719.

¹⁴¹ A. B. Charette and R. P. De Freitas-Gil, *Tetrahedron Lett.*, 1997, **38**, 2809–2812.

¹⁴² B. de Carné-Carvalet, A. Archambeau, C. Meyer, J. Cossy, B. Folléas, J.-L. Brayer and J.-P. Demoute, *Org. Lett.*, 2011, **13**, 956–959.

¹⁴³ (a) B. de Carné-Carvalet, A. Archambeau, C. Meyer, J. Cossy, B. Folléas, J.-L. Brayer and J.-P. Demoute, *Chem. Eur. J.*, 2012, **18**, 16716–16727; (b) B. de Carné-Carvalet, C. Meyer, J. Cossy, B. Folléas, J.-L. Brayer and J.-P. Demoute, *J. Org. Chem.*, 2013, **78**, 5794–5799.

¹⁴⁴ D. Gelman, S.-L. Buchwald, *Angew. Chem. Int. Ed.*, 2003, **42**, 5993–5996.

¹⁴⁵ J. P. Das and S. Roy, *J. Org. Chem.*, 2002, **67**, 7861–7864.

- ¹⁴⁶ C. Kaiser, A. Burger, L. Zirngibl, C. S. Davis and C. L. Zirkle *J. Org. Chem.*, 1962, **27**, 768–773.
- ¹⁴⁷ L. R. Cox, G. A. DeBoos, J. J. Fullbrook, J. M. Percy and N. Spencer *Tetrahedron: Asymmetry*, 2005, **16**, 347–359.
- ¹⁴⁸ R. S. Shank and H. Shechter, *J. Org. Chem.*, 1959, **24**, 1825–1826.
- ¹⁴⁹ R. A. Moss, B. Wilk, K. Krogh-Jespersen and J. D. Westbrook *J. Am. Chem. Soc.*, 1989, **111**, 6729–6734.
- ¹⁵⁰ S. E. Denmark and J. P. Edwards, *J. Org. Chem.*, 1991, **56**, 6974–6981.
- ¹⁵¹ L. J. Gooßen, N. Rodríguez, B. Melzer, C. Linder, G. Deng and L. M. Levy *J. Am. Chem. Soc.*, 2007, **129**, 4824–4833.
- ¹⁵² A. B. Charette, C. Molinaro and C. Brochu *J. Am. Chem. Soc.*, 2001, **123**, 12160–12167.
- ¹⁵³ A. Harizi, B. Hajjem, H. Zantour and B. Baccar, *Phosphorus, Sulfur Silicon Relat. Elem.*, 2000, **159**, 37–46.
- ¹⁵⁴ R. O. Larsen and G. Aksnes, *Phosphorus, Sulfur Silicon Relat. Elem.*, 1983, **15**, 219–228.
- ¹⁵⁵ Prepared according to the procedure described in: T. Sovdat, G. Bassolino, M. Liebel, C. Schnedermann, S. P. Fletcher, P. Kukura, *J. Am. Chem. Soc.*, 2012, **134**, 8318–8320.
- ¹⁵⁶ U. Schmidt, J. Langner, B. Kirschbaum and C. Braun, *Synthesis*, 1994, **11**, 1138–1140.
- ¹⁵⁷ M. T. Corbett, D. Uraguchi, T. Ooi, J. S. Johnson, *Angew. Chem., Int. Ed.*, 2012, **51**, 4685–4689.
- ¹⁵⁸ Y. Kaburagi and Y. Kishi, *Org. Lett.*, 2007, **9**, 723–726.
- ¹⁵⁹ S. Krehl, D. Geißler, S. Hauke, O. Kunz, L. Staude and B. Schmidt, *Beilstein J. Org. Chem.*, 2010, **6**, 1188–1198.
- ¹⁶⁰ S. Sobhani and Z. Tashrifi, *Synth. Commun.*, 2008, **39**, 120–131.
- ¹⁶¹ S. L. McDonald and Q. Wang, *Angew. Chem. Int. Ed.*, 2014, **53**, 1867–1871.
- ¹⁶² S. Lee, H.-J. Lim, K. L. Cha and G. A. Sulikowski, *Tetrahedron*, 1997, **53**, 16521–16532.
- ¹⁶³ S. Duce, A. Mateo, I. Alonso, J. L. García Ruano and M. B. Cid, *Chem. Commun.*, 2012, **48**, 5184–5186.
- ¹⁶⁴ This material was prepared according to a literature procedure.¹¹⁴

- ¹⁶⁵ This material was prepared according to a literature procedure.¹¹⁴
- ¹⁶⁶ R. Detterbeck and M. Hesse, *Helv. Chim. Acta*, 2003, **86**, 343–360.
- ¹⁶⁷ C. W. Alexander, D. De, I. K. Khanna and S. Pillarisetti, *US Pat.*, 2010 144 722, 2010.
- ¹⁶⁸ This material was prepared according to a literature procedure.¹¹⁶
- ¹⁶⁹ This material was prepared according to a literature procedure.¹¹⁵
- ¹⁷⁰ Prepared according to the procedure described in: R. Shang, Z.-W. Yang, Y. Wang, S.-L. Zhang and L. Liu, *J. Am. Chem. Soc.*, 2010, **132**, 14391–14393. Data matched literature.
- ¹⁷¹ Hydrolysis of the methyl ester in the presence of MeOH led to an S_NAr reaction in which the fluorine was replaced by a methoxy group.
- ¹⁷² S. L. Mndzhoyan, M. G. Tsinker, A. R. Ovakimyan, Y. Z. Ter-Zakharyan, É. V. Kazaryan and R. V. Paronikyan, *Pharm. Chem. J.* 1980, **14**, 114–118.
- ¹⁷³ The melting point could not be obtained as this compound underwent decarboxylation before melting.
- ¹⁷⁴ Prepared according to the procedure described in: B. J. Sargent, D. N. Johnston and A. P. A. Crew, *US Pat.*, 5 804 586, 1998.
- ¹⁷⁵ Prepared according to the procedure described in: A. Huang, A. Moretto, K. Janz, M. Lowe, P. W. Bedard, S. Tam, L. Di, V. Clerin, N. Sushkova, B. Tchernychev, D. H. H. Tsao, J. C. Keith, Jr., G. D. Shaw, R. G. Schaub, Q. Wang and N. Kaila, *J. Med. Chem.*, 2010, **53**, 6003–6017.
- ¹⁷⁶ L. A. Hardegger, B. Kuhn, B. Spinnler, L. Anselm, R. Ecabert, M. Stihle, B. Gsell, R. Thoma, J. Diez, J. Benz, J.-M. Plancher G. Hartmann, D. W. Banner, W. Haap and F. Diederich, *Angew. Chem., Int. Ed.*, 2011, **50**, 314–318.
- ¹⁷⁷ M. Zhang, X. Cui, X. Chen, L. Wang, J. Li, Y.-s. Wu, L. Hou and Y.-j. Wu, *Tetrahedron*, 2012, **68**, 900–905.
- ¹⁷⁸ T. G. Kutateladze, S. S. Mochalov, A. A. Borisenko, A. N. Fedotov, Y. S. Shabarov and S. Yu, *Russ. J. Org. Chem.* 1989, **25**, 1384–1396.
- ¹⁷⁹ M. Jeffrey, G. P Brady, Jr., T. F. Gallagher, D. A. Heerding, J. R. Medina and S. P. Romeril, *US Pat.*, 120 854, 2010.
- ¹⁸⁰ Y. Sun, H. Jiang, W. Wu, W. Zeng and X. Wu, *Org. Lett.* 2013, **15**, 1598–1601.
- ¹⁸¹ Y.-H. Yang and M. Shi, *Tetrahedron*, 2006, **62**, 2420–2427.

- ¹⁸² A.-H. Li, D. J. Beard, H. Coate, A. Honda, M. Kadalbajoo, A. Kleinberg, R. Laufer, K. M. Mulvihill, A. Nigro, P. Rastogi, D. Sherman, K. W. Siu, A. G. Steinig, T. Wang, D. Werner, A. P. Crew and M. J. Mulvihill, *Synthesis*, 2010, 1678–1686.
- ¹⁸³ K. Kulbitski, G. Nisnevich and M. Gandelman *Adv. Synth. Catal.*, 2011, **353**, 1438–1442.
- ¹⁸⁴ M. P. Huestis, L. Chan, D. R. Stuart and K. Fagnou *Angew. Chem. Int. Ed.*, 2011, **50**, 1338–1341.
- ¹⁸⁵ A. S. Batsanov, J. P. Knowles and A. Whiting *J. Org. Chem.*, 2007, **72**, 2525–2532.
- ¹⁸⁶ X. Li, X.-Y. Yan, H.-H. Chang, L.-C. Wang, Y. Zhang, W.-W. Chen, Y.-W. Li and W.-L. Wei *Org. Biomol. Chem.*, 2012, **10**, 495–497.