

One-loop $\mathcal{N} = 8$ supergravity coefficients from $\mathcal{N} = 4$ super Yang-Mills

Panagiotis Katsaroumpas, Bill Spence and Gabriele Travaglini¹

*Centre for Research in String Theory
Department of Physics
Queen Mary, University of London
Mile End Road, London, E1 4NS
United Kingdom*

Abstract

We use supersymmetric generalised unitarity to calculate supercoefficients of box functions in the expansion of scattering amplitudes in $\mathcal{N} = 8$ supergravity at one loop. Recent advances have presented tree-level amplitudes in $\mathcal{N} = 8$ supergravity in terms of sums of terms containing squares of colour-ordered Yang-Mills superamplitudes. We develop the consequences of these results for the structure of one-loop supercoefficients, recasting them as sums of squares of $\mathcal{N} = 4$ Yang-Mills expressions with certain coefficients inherited from the tree-level superamplitudes. This provides new expressions for all one-loop box coefficients in $\mathcal{N} = 8$ supergravity, which we check against known results in a number of cases.

¹ {p.katsaroumpas, w.j.spence, g.travaglini}@qmul.ac.uk

1 Introduction

Recent advances have indicated that gravity scattering amplitudes are much simpler than what one would infer from the Feynman diagram expansion, very much like in Yang-Mills theory. In [1, 2], on-shell recursion relations were written down for graviton amplitudes at tree level, and a remarkably benign ultraviolet behaviour of the scattering amplitudes under certain large deformations along complex directions in momentum space was observed. This behaviour, not apparent from a simple analysis based on Feynman diagram considerations [1, 2] similar to those discussed in [3] for Yang-Mills amplitudes, was later re-examined and explained in [4–6].

At the quantum level, unexpected cancellations occur in maximal supergravity starting at one loop, which led to the conjecture [7–10] and later proof [6, 11] of the “no-triangle hypothesis”. According to this property, all one-loop amplitudes in $\mathcal{N} = 8$ supergravity can be written as sums of box functions times rational coefficients, similarly to one-loop amplitudes in $\mathcal{N} = 4$ super Yang-Mills (SYM). Interesting connections were established in [12] and [11, 13] between one-loop cancellations, and the large- z behaviour observed in [1, 2, 4–6], as well as the presence of summations over different orderings of the external particles typical of unordered theories such as gravity (and QED). There is therefore growing evidence of the remarkable similarities between the two maximally supersymmetric theories, $\mathcal{N} = 4$ SYM and $\mathcal{N} = 8$ supergravity, culminating in the conjecture that the $\mathcal{N} = 8$ theory could be ultraviolet finite, just like its non-gravitational maximally supersymmetric counterpart. This is supported both by multi-loop perturbative calculations [12, 14–16], and string theory and M-theory considerations [17–20].

In a recent paper [21], Elvang and Freedman were able to recast n -graviton MHV amplitudes at tree level in a suggestive form in terms of sums of squares of n -gluon MHV amplitudes. An analytical proof for all n of the agreement of their expression to that for the infinite sequence of MHV amplitudes conjectured from recursion relations in [1] was also presented, as well as numerical checks showing agreement with the Berends-Giele-Kuijf formula [22]. A direct proof of the formula of [21] was later given in [23].

In a related development at tree level, the authors of [24] used supersymmetric recursion relations [6, 25] of the BCF type [3, 26], and the explicit solution found in the $\mathcal{N} = 4$ case in [27], to recast amplitudes in $\mathcal{N} = 8$ supergravity in a new simplified form which involves sums of $\mathcal{N} = 4$ amplitudes. Specifically, according to [24] a generic $\mathcal{N} = 8$ superamplitude can be written as

$$\mathcal{M}(1, \dots, n) = \sum_{\mathcal{P}(2, \dots, n-1)} M(1, \dots, n) , \quad (1.1)$$

where the ordered subamplitudes $M(1, \dots, n)$ are [24]:

$$M(1, \dots, n) = [A^{\text{MHV}}(1, \dots, n)]^2 \sum_{\alpha} [R_{\alpha}(\lambda_i, \tilde{\lambda}_i, \eta_i)]^2 G_{\alpha}(\lambda_i, \tilde{\lambda}_i). \quad (1.2)$$

Here $A^{\text{MHV}}(1, \dots, n)$ is the MHV superamplitude in $\mathcal{N} = 4$ SYM [28], and R_{α} are certain dual superconformal invariant quantities [27], extending those introduced in [29, 30] for the next-to-MHV (NMHV) superamplitudes. G_{α} are certain gravity “dressing factors”, which are independent of the superspace variables η_i associated to each particle i in the amplitude. Finally, the sum in (1.1) is over all permutations of the labels $(2, \dots, n-1)$. The fact that the sum over permutations in (1.1) does not contain two of the n scattered particles will be important in what follows.

Turning to loop amplitudes, it has been shown recently in [29] that four-dimensional generalised unitarity [31] may be efficiently applied to calculate the supercoefficients of one-loop superamplitudes in $\mathcal{N} = 4$ SYM. One of the advantages of the use of superamplitudes is that it makes it particularly efficient to perform the sums over internal helicities [6, 29, 32–37], which are converted into fermionic integrals. Furthermore, according to the no-triangle property of maximal supergravity [6–11], one-loop amplitudes in the $\mathcal{N} = 8$ theory are expressed in terms of box functions only, therefore the coefficients of one-loop amplitudes can be calculated by using quadruple cuts. It is therefore natural to investigate how the new expressions for generic tree-level $\mathcal{N} = 8$ supergravity amplitudes found in [24] can be used together with supersymmetric quadruple cuts [29] in order to derive new formulae for one-loop amplitudes in $\mathcal{N} = 8$ supergravity. This will be the main goal of this paper.

One interesting consequence of the structure of (1.1) for the results we derive for the one-loop box supercoefficients is that when the expressions for tree-level amplitudes are inserted into quadruple cuts, they give rise to new general formulae for the supercoefficients that are written as sums of squares of the result of the corresponding $\mathcal{N} = 4$ SYM calculation (apart from the four-mass case, this will be the square of an $\mathcal{N} = 4$ coefficient), multiplied by certain dressing factors. The one-loop supercoefficients therefore inherit the intriguing structure of tree-level amplitudes exhibited by (1.1) and (1.2).

Specifically, we will calculate supercoefficients for MHV, NMHV and N^2MHV superamplitudes, and we will show in a number of cases how these new expressions match known formulae. In particular, we will show how our results agree with the expressions for the infinite sequence of MHV amplitudes obtained in [7] using unitarity, with the five-point NMHV amplitude [7], and with the six-point graviton NMHV amplitudes coefficients derived in [8, 9]. In the MHV case, we propose a correspondence between the “half-soft” functions introduced in [7] and particular sums of dressing factors, which we check numerically up to 12 external legs. In [7–9], the tree-level amplitudes entering the cut had been generated using KLT relations [38]; in our ap-

proach, we will instead use the solution of the supersymmetric recursion relation given by (1.1) and (1.2). Our results support the conjecture that all one-loop amplitude coefficients in $\mathcal{N} = 8$ supergravity may be written in terms of $\mathcal{N} = 4$ Yang-Mills expressions times known dressing factors.

The rest of the paper is organised as follows. In the next section we will briefly review some background material needed in order to describe amplitudes in maximally supersymmetric theories, and quadruple cuts. In Section 3 we will study MHV superamplitudes at one loop, deriving a straightforward general expression for the supercoefficients in the n -point case. We propose a conjecture which enables an immediate correspondence to be made with the known general formula for these amplitudes, and test this explicitly for $2me$ coefficients with up to $n = 22$ external legs. Section 4 turns to consider NMHV amplitudes. We derive general expressions for the $3m$ and $2me$ box coefficients, and the related $2mh$ and $1m$ coefficients. Similarly to the SYM case considered in [29], all the supercoefficients can be written in terms of the $3m$ coefficients, which we are able to recast as sums of squares of the corresponding SYM $3m$ coefficients, times certain bosonic dressing factors. In Section 5 we study explicit examples, starting with the five-point NMHV case, which provides a simple toy model for studying structures at higher points, and we then discuss the six-point NMHV case. In Section 6 we describe how this approach applies in general to N^p MHV amplitude coefficients. We conclude with some discussion of further work.

Note added: After this paper was completed, we became aware of [39], which appears to overlap with our paper.

2 Background

In the supersymmetric formalism of [28], one associates to each particle in the $\mathcal{N} = 8$ theory the usual commuting spinors $\lambda_\alpha, \tilde{\lambda}_{\dot{\alpha}}$ (in terms of which the momentum of the i^{th} particle is $p_{\alpha\dot{\alpha}}^i = \lambda_\alpha^i \tilde{\lambda}_{\dot{\alpha}}^i$), as well as anticommuting variables η_i^A , where $A = 1, \dots, 8$ is an $SU(8)$ index. The supersymmetric amplitude can then be expanded in powers of the $\mathcal{N} = 8$ superspace coordinates η_A^i for the different particles, and each term of this expansion corresponds to a particular scattering amplitude in $\mathcal{N} = 8$ supergravity. In particular, a term containing m_i powers of η_A^i corresponds to a scattering process where the i^{th} particle has helicity $h_i = 2 - m_i/2$.

Generalising the discussion of [29] to $\mathcal{N} = 8$ supergravity, we write a generic n -point superamplitude with $n > 3$ as

$$\mathcal{M}_n(\lambda, \tilde{\lambda}, \eta) = i(2\pi)^4 \delta^{(4)}(p) \delta^{(16)}(q) \mathcal{P}_n(\lambda, \tilde{\lambda}, \eta), \quad (2.1)$$

where the function \mathcal{P}_n has the form

$$\mathcal{P}_n = \mathcal{P}_n^{(0)} + \mathcal{P}_n^{(8)} + \mathcal{P}_n^{(16)} + \dots + \mathcal{P}_n^{(8n-32)}, \quad (2.2)$$

where $\mathcal{P}_n^{(8k)}(\lambda, \tilde{\lambda}, \eta)$ is an $SU(8)$ invariant homogenous polynomial in the η 's of degree $8k$. Furthermore $p := \sum_{i=1}^n \lambda_i \tilde{\lambda}_i$ is the total momentum of the particles, and $q_\alpha^A := \sum_{i=1}^n q_{\alpha;i}^A$ is the sum of the supermomenta $q_{\alpha;i}^A := \eta_i^A \lambda_{\alpha;i}$ of each particle i . The fermionic delta function $\delta^{(16)}(q_\alpha^A)$ raises the degree of each term to $8k + 16$. Each η_i^A carries helicity of $1/2$, therefore the term $\delta^{(16)}(q_\alpha^A) \mathcal{P}_n^{(8k)}(\lambda, \tilde{\lambda}, \eta)$ has total helicity of $2k + 8$, giving the $N^k\text{MHV}$ amplitude.

The three-point supergravity amplitudes are given by [6]

$$\mathcal{M}_3^{\text{MHV}}(1, 2, 3) = [A_3^{\text{MHV}}(1, 2, 3)]^2 = \frac{\delta^{(16)}(\sum_{i=1}^n \eta_i \lambda_i)}{(\langle 12 \rangle \langle 23 \rangle \langle 31 \rangle)^2}, \quad (2.3)$$

$$\mathcal{M}_3^{\overline{\text{MHV}}}(1, 2, 3) = [A_3^{\overline{\text{MHV}}}(1, 2, 3)]^2 = \frac{\delta^{(8)}(\eta_1[23] + \eta_2[31] + \eta_3[12])}{([12][23][31])^2}, \quad (2.4)$$

and are obtained by simply squaring the corresponding MHV [28] and anti-MHV [6,25] superamplitudes in $\mathcal{N} = 4$ SYM. Notice in (2.4) the presence of an unusual fermionic delta function. It is also easy to show that (2.4) is invariant under all supersymmetries.

One-loop amplitudes can be expanded in a known basis of scalar integrals which, in maximally supersymmetric theories, contains only box functions. This was shown in [40] for the SYM case, and is the content of the no-triangle property mentioned earlier. We will therefore write a generic one-loop superamplitude in maximal supergravity as

$$\mathcal{M}_n^{1\text{-loop}} = \sum \mathcal{C}_n(P_1, P_2, P_3, P_4) \mathcal{I}(P_1, P_2, P_3, P_4), \quad (2.5)$$

where we are summing over all distinct scalar box functions $\mathcal{I}(P_1, P_2, P_3, P_4)$ with external momenta P_1, \dots, P_4 [41], and $\mathcal{C}_n(P_1, P_2, P_3, P_4)$ are the supercoefficients of the expansion.

Using generalised unitarity in four dimensions, the one-loop supercoefficients of maximal supergravity amplitudes can be expressed in terms of products of four tree-level amplitudes as

$$\begin{aligned} \mathcal{C}(P_1, P_2, P_3, P_4) &= \frac{1}{2} \sum_{\mathcal{S}_\pm} \int \prod_{i=1}^4 d^8 \eta_i \\ &\times \mathcal{M}(-l_1, P_1, l_2) \mathcal{M}(-l_2, P_2, l_3) \mathcal{M}(-l_3, P_3, l_4) \mathcal{M}(-l_4, P_4, l_1), \end{aligned} \quad (2.6)$$

where we are averaging over the two solutions \mathcal{S}_\pm to the cut conditions $l_i^2 = 0$, $i = 1, \dots, 4$, which impose that all the internal propagators are on shell [31], and

supermomentum conservation delta functions for each of the four amplitudes entering (2.6) are understood. The integration is performed over the four Grassmann variables η_i , $i = 1, \dots, 4$ associated with the internal cut legs.

In the next sections we will describe how (2.6) can be applied to obtain supercoefficients for the MHV and NMHV amplitudes in maximal supergravity.

3 One-loop MHV superamplitudes

In [29], the one-loop MHV superamplitude in $\mathcal{N} = 4$ SYM was derived using a supersymmetric extension of the quadruple unitarity cuts of [31]. It turns out that many of the details of the calculation presented in [29] carry over directly to the supergravity case, and we will follow closely the notation of these authors in order to simplify the comparison.

We begin by giving the expression derived in [29] for the supercoefficient of the generic diagram contributing to the MHV superamplitude, drawn in Figure 1,

$$\begin{aligned} \mathcal{C}^{\mathcal{N}=4}(1, P, s, Q) &= \frac{1}{2} \sum_{S_{\pm}} \int \prod_{i=1}^4 d^4 \eta_i \quad (3.1) \\ &\times \frac{\delta^{(4)}(\eta_1[l_2 l_1] + \eta_2[l_1 1] + \eta_3[1 l_2]) \delta^{(8)}(\lambda_{l_2} \eta_{l_2} + \sum_2^{s-1} \lambda_i \eta_i - \lambda_{l_3} \eta_{l_3})}{[1 l_2][l_2 l_1][l_1 1] \langle l_2 2 \rangle \cdots \langle s-1 l_3 \rangle \langle l_3 l_2 \rangle} \\ &\times \frac{\delta^{(4)}(\eta_{l_3}[s l_4] + \eta_s[l_4 l_3] + \eta_{l_4}[l_3 s]) \delta^{(8)}(\lambda_{l_4} \eta_{l_4} + \sum_{s+1}^n \lambda_i \eta_i - \lambda_{l_1} \eta_{l_1})}{[l_3 s][s l_4][l_4 l_3] \langle l_4 s+1 \rangle \cdots \langle n l_1 \rangle \langle l_1 l_4 \rangle}, \end{aligned}$$

where the sum goes over the two solutions to the cut equations. The four terms in (3.1) come from the product of the four tree-level amplitudes in the diagram,

$$A_3^{\overline{\text{MHV}}}(-l_1, 1, l_2) A(-l_2, 2, \dots, s-1, l_3) A_3^{\overline{\text{MHV}}}(-l_3, s, l_4) A^{\text{MHV}}(-l_4, s+1, \dots, n, l_1), \quad (3.2)$$

where A^{MHV} is the MHV superamplitude [28],

$$A_n^{\text{MHV}}(1, \dots, n) = \frac{\delta^{(8)}(\sum_{i=1}^n \eta_i \lambda_i)}{N(1, 2, \dots, n)}, \quad (3.3)$$

and we have defined

$$N(1, 2, \dots, n) := \langle 12 \rangle \langle 23 \rangle \cdots \langle n1 \rangle. \quad (3.4)$$

As shown in [29], the result of evaluating (3.1) is

$$\mathcal{C}^{\mathcal{N}=4}(1, P, s, Q) = \frac{1}{2} (P^2 Q^2 - st) \frac{\delta^{(8)}(\sum_{i=1}^n \eta_i \lambda_i)}{N(1, 2, \dots, n)}. \quad (3.5)$$

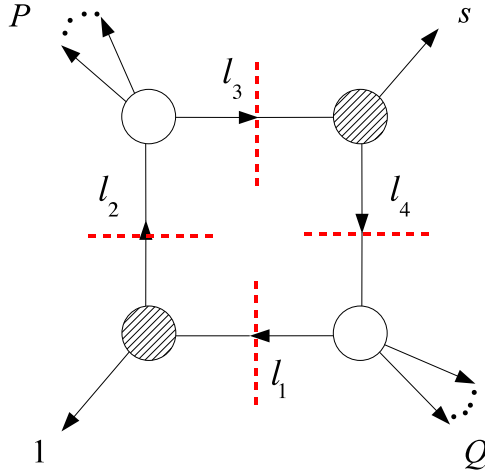

Figure 1: A quadruple cut diagram determining the supercoefficient $\mathcal{C}^{\mathcal{N}=4}(1, P, s, Q)$ in the MHV superamplitudes in $\mathcal{N} = 4$ SYM and $\mathcal{N} = 8$ supergravity. The two three-point amplitudes have the anti-MHV helicity configurations, and the remaining two amplitudes are MHV's.

Incidentally, we notice that in order to arrive at (3.5) it is not necessary to know the explicit solutions to the cut equations, but only that the holomorphic spinors at the three-point anti-MHV corners are proportional, i.e. $\lambda_{l_1} \propto \lambda_{l_2} \propto \lambda_1$, $\lambda_{l_3} \propto \lambda_{l_4} \propto \lambda_s$. We also notice that for $n > 4$ only one of the two cut solutions contributes to the cut diagram of Figure 1. This leads to the factor of $1/2$ on the right-hand side of (3.5).

Let us now consider the same quadruple-cut diagram but in the $\mathcal{N} = 8$ supergravity case. The supercoefficient is given by the following integral,

$$\mathcal{C}^{\mathcal{N}=8}(1, P, s, Q) = \frac{1}{2} \sum_{S_{\pm}} \int \prod_{i=1}^4 d^8 \eta_i \mathcal{M}_3^{\overline{\text{MHV}}}(-l_1, 1, l_2) \mathcal{M}^{\text{MHV}}(-l_2, 2, \dots, s-1, l_3) \mathcal{M}_3^{\overline{\text{MHV}}}(-l_3, s, l_4) \mathcal{M}^{\text{MHV}}(-l_4, s+1, \dots, n, l_1), \quad (3.6)$$

where we sum over the same two solutions of the cut equations as in the Yang-Mills case, but now integrate over the eight superspace variables η^A , $A = 1, \dots, 8$, and insert the tree-level MHV and anti-MHV supergravity amplitudes \mathcal{M}^{MHV} and $\mathcal{M}^{\overline{\text{MHV}}}$.

The simplification in calculating (3.6) comes when we utilise the result of Elvang and Freedman [21], who have given the following expression for the n -point ($n > 3$) tree-level MHV supergravity amplitudes in terms of the Yang-Mills MHV tree

amplitudes and certain “dressing factors” G^{MHV} :

$$\mathcal{M}_n^{\text{MHV}} = \sum_{\mathcal{P}(2, \dots, n-1)} [A^{\text{MHV}}(1, \dots, n)]^2 G^{\text{MHV}}(1, \dots, n), \quad (3.7)$$

where we sum over permutations $\mathcal{P}(2, \dots, n-1)$ of the elements $(2, \dots, n-1)$, and the dressing factors are given by

$$G^{\text{MHV}}(1, \dots, n) = x_{13}^2 \prod_{s=2}^{n-3} \frac{\langle s | x_{s, s+2} x_{s+2, n} | n \rangle}{\langle sn \rangle}. \quad (3.8)$$

We have used in the above the form of the result as given in [24]. Note that the dressing factors are independent of the superspace variables η_i .

Now we may insert these expressions into the formula (3.6) to find the box coefficients $\mathcal{C}^{\mathcal{N}=8}(1, P, s, Q)$. This results in a sum of products of squares of Yang-Mills superamplitudes, times dressing factors. The key point here is that since the dressing factors are independent of the superspace variables, we may follow exactly the manipulations of [29] in order to carry out the superspace integrations, and this will yield exactly the square of the Yang-Mills result (3.5). We follow the conventions of [24] with regard to squaring delta functions, in particular it is understood that

$$\left(\delta^{(8)} \left(\sum_{i=1}^n \eta_i \lambda_i \right) \right)^2 = \delta^{(16)} \left(\sum_{i=1}^n \eta_i \lambda_i \right), \quad (3.9)$$

where there are the four Yang-Mills η variables on the left-hand side of this expression and the eight supergravity ones on the right-hand side.

Hence the result of the superspace integrals in (3.6) is

$$\begin{aligned} \mathcal{C}^{\mathcal{N}=8}(1, P, s, Q) &= \frac{1}{2} (P^2 Q^2 - st)^2 \sum_{S_{\pm}} \sum_{\mathcal{P}(2, \dots, s-1)} \sum_{\mathcal{P}(s+1, \dots, n)} \\ &\times \frac{G^{\text{MHV}}(-l_2, 2, \dots, s-1, l_3) G^{\text{MHV}}(-l_4, s+1, \dots, n, l_1)}{(N(1, \dots, n))^2}, \end{aligned} \quad (3.10)$$

where the dressing factors G^{MHV} are given by (3.8), and the first summation involves inserting the explicit solutions to the quadruple cut conditions. This solution is very easy to determine for the two-mass easy box case. In the specific cut in Figure 1, where the two three-point superamplitudes have the anti-MHV helicity configuration, there is only one solution for the cut loop momenta, which has the form

$$l_1 = \lambda_1 \tilde{\lambda}_{l_1}, \quad l_2 = \lambda_1 \tilde{\lambda}_{l_2}, \quad l_3 = \lambda_s \tilde{\lambda}_{l_3}, \quad l_4 = \lambda_s \tilde{\lambda}_{l_4}, \quad (3.11)$$

and we wish to determine $\tilde{\lambda}_{l_1}, \dots, \tilde{\lambda}_{l_4}$. This is accomplished by imposing momentum conservation at the four corners of the cut diagram. The result is

$$\tilde{\lambda}_{l_1} = -\frac{\langle s | Q \rangle}{\langle s 1 \rangle}, \quad \tilde{\lambda}_{l_2} = \frac{\langle s | P \rangle}{\langle s 1 \rangle}, \quad \tilde{\lambda}_{l_3} = -\frac{\langle 1 | P \rangle}{\langle 1 s \rangle}, \quad \tilde{\lambda}_{l_4} = \frac{\langle 1 | Q \rangle}{\langle 1 s \rangle}, \quad (3.12)$$

from which the cut momenta l_1, \dots, l_4 are then obtained using (3.11),

$$l_1 = -|1\rangle \frac{\langle s|Q}{\langle s1\rangle}, \quad l_2 = |1\rangle \frac{\langle s|P}{\langle s1\rangle}, \quad l_3 = -|s\rangle \frac{\langle 1|P}{\langle 1s\rangle}, \quad l_4 = |s\rangle \frac{\langle 1|Q}{\langle 1s\rangle}. \quad (3.13)$$

Given that only one solution to the cut contributes, one can drop the sum over \mathcal{S}_\pm in (3.10), and a factor of 1/2 is left over.

Taking this into account, we can instantly recast (3.10) as

$$\mathcal{C}^{\mathcal{N}=8}(1, P, s, Q) = \sum_{\mathcal{P}(P)} \sum_{\mathcal{P}(Q)} \left[\mathcal{C}^{\mathcal{N}=4}(1, P, s, Q) \right]^2 2 G^{\text{MHV}}(-l_2, P, l_3) G^{\text{MHV}}(-l_4, Q, l_1), \quad (3.14)$$

where P and Q here denote the sets $P = \{2, \dots, s-1\}$ and $Q = \{s+1, \dots, n\}$. The $\mathcal{N} = 4$ supercoefficient $\mathcal{C}^{\mathcal{N}=4}(1, P, s, Q)$ is given in (3.5), and the loop momenta are evaluated on the solution provided by (3.13). The expression (3.14) gives a new form of the one-loop integral coefficients in the supergravity MHV amplitudes for any number of external legs.

Next we would like to compare our result (3.14) to previously known expressions for the MHV coefficients. In [7] the infinite sequence of graviton MHV amplitudes was presented. The result of that paper for the two-mass easy coefficients is¹

$$\mathcal{C}^{\mathcal{N}=8}(1, P, s, Q) = \frac{1}{2} (P^2 Q^2 - st)^2 h(1, \{P\}, s) h(s, \{Q\}, 1). \quad (3.15)$$

The first three ‘‘half-soft’’ functions $h(a, M, b)$ are given by

$$\begin{aligned} h(a, \{1\}, b) &= \frac{1}{\langle a1\rangle^2 \langle 1b\rangle^2}, & (3.16) \\ h(a, \{1, 2\}, b) &= \frac{[12]}{\langle 12\rangle \langle a1\rangle \langle 1b\rangle \langle a2\rangle \langle 2b\rangle}, \\ h(a, \{1, 2, 3\}, b) &= \frac{[12][23]}{\langle 12\rangle \langle 23\rangle \langle a1\rangle \langle 1b\rangle \langle a3\rangle \langle 3b\rangle} + \frac{[23][31]}{\langle 23\rangle \langle 31\rangle \langle a2\rangle \langle 2b\rangle \langle a1\rangle \langle 1b\rangle} \\ &+ \frac{[31][12]}{\langle 31\rangle \langle 12\rangle \langle a3\rangle \langle 3b\rangle \langle a2\rangle \langle 2b\rangle}. \end{aligned}$$

A recursive form for the h functions is also given in [7] as well as the following explicit formula:

$$\begin{aligned} h(a, \{1, 2, \dots, n\}, b) &= \frac{[12]}{\langle 12\rangle} \frac{\langle a|K_{1,2}|3\rangle \langle a|K_{1,3}|4\rangle \cdots \langle a|K_{1,n-1}|n\rangle}{\langle 23\rangle \langle 34\rangle \cdots \langle n-1n\rangle \langle a1\rangle \langle a2\rangle \cdots \langle an\rangle \langle 1b\rangle \langle nb\rangle} \\ &+ \mathcal{P}(2, 3, \dots, n), \end{aligned} \quad (3.17)$$

¹A factor of $(-1)^n$ in the result of [7] for the $2me$ coefficients can be attributed to different conventions.

where $K_{i,j} = k_i + k_{i+1} + \dots + k_j$.

In order to show that the two expressions (3.14) and (3.15) for the one-loop MHV amplitude coefficients are equivalent, we consider a massive tree sub-amplitude in the loop diagram under consideration, for example that containing the set of momenta $Q = \{s+1, \dots, n\}$, with internal loop momenta l_4, l_1 . We now make the following conjecture relating the h functions in (3.15) to the dressing factors G of (3.10):

$$\sum_{\mathcal{P}(s+1, \dots, n)} \frac{G^{\text{MHV}}(-l_4, Q, l_1)}{(\langle ss+1 \rangle \langle s+1s+2 \rangle \dots \langle n-1n \rangle \langle n1 \rangle)^2} = h(s, \{Q\}, 1), \quad (3.18)$$

where it is assumed that a solution to the cut loop momentum constraints is inserted in the left-hand side of this equation. If this relation is true, it follows directly that our formula (3.14) is identical to (3.15). Let us first see how the equality (3.18) works in some simple cases.

For the case where Q is a single momentum, the result (3.18) is immediate since $G(a, b, c) = 1$ and $h(a, \{b\}, c) = 1/(\langle ab \rangle \langle bc \rangle)^2$.

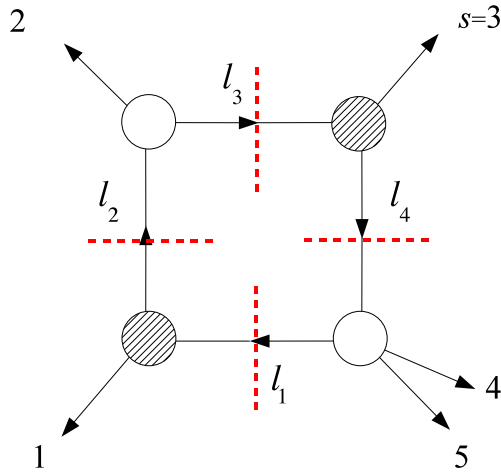

Figure 2: *The quadruple cut diagram considered for the derivation of (3.19).*

The next check we perform is for the case when Q contains two momenta, where we suppose that the labels of the amplitude are $(-l_4, 4, 5, l_1)$, with the neighbouring external legs being labeled 3 and 1, as in Figure 2. Then we wish to show that

$$\sum_{\mathcal{P}(4,5)} \frac{G^{\text{MHV}}(-l_4, 4, 5, l_1)}{(\langle 34 \rangle \langle 45 \rangle \langle 51 \rangle)^2} = h(3, \{4, 5\}, 1). \quad (3.19)$$

The loop variable solution is in this case

$$l_1 = \frac{\langle 34 \rangle |1\rangle |4\rangle + \langle 35 \rangle |1\rangle |5\rangle}{\langle 13 \rangle}, \quad (3.20)$$

which follows from (3.13) with $Q = p_4 + p_5$. We also notice that the four-point dressing factor is given by the same expression in (3.8) but without the product, i.e. $G^{\text{MHV}}(1, 2, 3, 4) = x_{13}^2$. Taking this into account, inserting (3.20) into the left-hand side of (3.19) and using standard identities, we arrive at

$$\sum_{\mathcal{P}(4,5)} \frac{G^{\text{MHV}}(-l_4, 4, 5, l_1)}{(\langle 34 \rangle \langle 45 \rangle \langle 51 \rangle)^2} = \frac{[45]}{\langle 45 \rangle} \frac{1}{\langle 34 \rangle \langle 41 \rangle \langle 35 \rangle \langle 51 \rangle}, \quad (3.21)$$

which is precisely $h(3, \{4, 5\}, 1)$. Note that we did not use any properties of the momenta at the other massive tree amplitude in any diagram containing this one.

For the next case, let us suppose that the labels of its legs are $(l_4, 4, 5, 6, l_1)$, with the neighbouring external legs being labeled 3 and 1 again. Then we wish to show that

$$\sum_{\mathcal{P}(4,5,6)} \frac{G^{\text{MHV}}(-l_4, 4, 5, 6, l_1)}{(\langle 34 \rangle \langle 45 \rangle \langle 56 \rangle \langle 61 \rangle)^2} = h(3, \{4, 5, 6\}, 1). \quad (3.22)$$

The loop variable solution which we will use in this case follows again from (3.13) with $Q = p_3 + p_4 + p_5$,

$$l_1 = \frac{1}{\langle 13 \rangle} \left(\langle 34 \rangle |1\rangle |4\rangle + \langle 35 \rangle |1\rangle |5\rangle + \langle 36 \rangle |1\rangle |6\rangle \right). \quad (3.23)$$

Inserting this into the left-hand side of (3.22) one finds

$$\sum_{\mathcal{P}(4,5,6)} \frac{G^{\text{MHV}}(-l_4, 4, 5, 6, l_1)}{(\langle 34 \rangle \langle 45 \rangle \langle 56 \rangle \langle 61 \rangle)^2} = \frac{1}{\langle 13 \rangle} \sum_{\mathcal{P}(4,5,6)} \frac{[56](\langle 45 \rangle \langle 15 \rangle + [46] \langle 16 \rangle)}{\langle 14 \rangle \langle 34 \rangle \langle 45 \rangle \langle 16 \rangle \langle 56 \rangle^2}. \quad (3.24)$$

Adding the terms from the permutations (456) and (465) it is straightforward to obtain the first term of $h(3, \{4, 5, 6\}, 1)$ as given using the last formula in (3.16); the cyclically rotated terms are obtained in the same way.

To study the conjecture (3.18) in general, we consider the quadruple cut diagram in Figure 3. Again only one solution to the cut equations contributes; we will need explicit expressions for the cut momenta l_1 and l_4 , which are given by

$$l_1 = \frac{1}{\langle 1s \rangle} \sum_{i=s+1}^n \langle si \rangle |1\rangle |i\rangle, \quad l_4 = \frac{1}{\langle s1 \rangle} \sum_{i=s+1}^n \langle i1 \rangle |s\rangle |i\rangle. \quad (3.25)$$

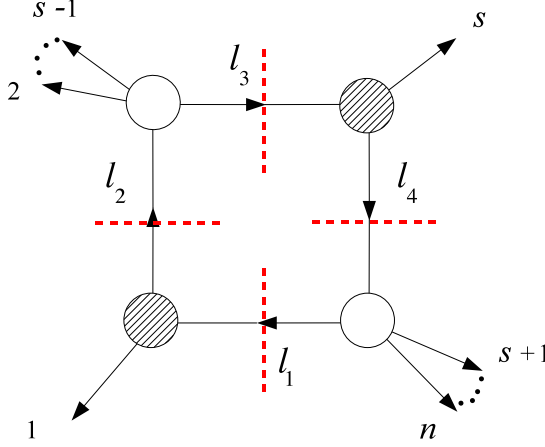

Figure 3: *The quadruple cut diagram determining the two-mass easy supercoefficient $\mathcal{C}^{\mathcal{N}=8}(1, P, s, Q)$ in the MHV amplitudes in $\mathcal{N} = 8$ supergravity where $P := \sum_{l=2}^{s-1} p_l$, $Q := \sum_{l=s+1}^n p_l$. The black blobs denote anti-MHV three-point amplitudes, the remaining amplitudes have the MHV helicity configuration.*

Consider first the dressing factor from the MHV amplitude $\mathcal{M}^{\text{MHV}}(-l_4, s+1, \dots, n, l_1)$. This is given by

$$G^{\text{MHV}}(-l_4, s+1, \dots, n, l_1) = s_{-l_4, s+1} \prod_{r=s+1}^{n-2} \frac{\langle r|(r+1) \sum_{i=r+2}^n i|l_1 \rangle}{\langle r l_1 \rangle}, \quad (3.26)$$

where

$$s_{-l_4, s+1} = \frac{1}{\langle 1s \rangle} \sum_{i=s+1}^n \langle i1 \rangle \langle s s+1 \rangle [s+1 i]. \quad (3.27)$$

Inserting the solution for the cut loop momenta into $G^{\text{MHV}}(-l_4, s+1, \dots, n, l_1)$, and denoting the corresponding quantity $G'(s, \{s+1, \dots, n\}, 1)$, one finds

$$G'(s, \{s+1, \dots, n\}, 1) = \frac{1}{\langle 1s \rangle} \left(\sum_{i=s+1}^n \langle i1 \rangle \langle s s+1 \rangle [s+1 i] \right) \prod_{r=s+1}^{n-2} \frac{\langle r|(r+1) \sum_{i=r+2}^n i|1 \rangle}{\langle r1 \rangle}. \quad (3.28)$$

We have checked numerically that

$$\sum_{\mathcal{P}(s+1, \dots, n)} \frac{G'(s, \{s+1, \dots, n\}, 1)}{\left(\langle s(s+1) \rangle \langle (s+1)(s+2) \rangle \cdots \langle n1 \rangle \right)^2} = h(s, \{s+1, \dots, n\}, 1), \quad (3.29)$$

for up to 12 legs, i.e. for n up to $s+10$. Note that an identical argument applies to the other massive corner with momentum $P := \sum_{l=2}^{s-1} p_l$ in the $2me$ box diagram.

Therefore, this numerical check shows that the two expressions (3.14) and (3.15) for the $2me$ coefficients are equivalent for up to 22 external legs, whereas for the $1m$ diagrams, the equivalence is up to 13 legs.

With the loop solutions inserted, our expression for the MHV amplitudes in supergravity is then given by

$$\mathcal{C}^{\mathcal{N}=8}(1, P, s, Q) = \sum_{\mathcal{P}(P)} \sum_{\mathcal{P}(Q)} (\mathcal{C}^{\mathcal{N}=4}(1, P, s, Q))^2 G'(1, P, s) G'(s, Q, 1). \quad (3.30)$$

These results indicate that generalised unitarity works for the MHV superamplitudes at one loop, and utilising suitable expressions for the tree amplitudes in this process, one derives expressions for the supergravity coefficients as sums of squares of SYM coefficients times known dressing factors, as given in the equation above.

We now move on to consider NMHV superamplitudes.

4 Next-to-MHV supergravity amplitudes

For next-to-MHV amplitudes in $\mathcal{N} = 8$ supergravity, the three-mass and two-mass hard box functions also appear, in addition to the two-mass easy and one-mass ones. The relevant quadruple cut diagrams are the same as those appearing in [29] in the $\mathcal{N} = 4$ SYM case. In the following, we will give general expressions for the different box coefficients.

4.1 Three-mass and two-mass hard coefficients

We begin by considering three-mass coefficients. In this case, there is one quadruple cut diagram containing three MHV amplitudes and one anti-MHV, with each MHV amplitude containing more than three legs in general. The relevant quadruple cut diagram is represented in Figure 4 and yields the expression

$$\begin{aligned} \mathcal{C}_{3m}^{\mathcal{N}=8}(r, P, Q, R) = & \frac{1}{2} \sum_{\mathcal{S}_{\pm}} \int \prod_{i=1}^4 d^8 \eta_{l_i} \mathcal{M}_3^{\overline{\text{MHV}}}(-l_1, r, l_2) \mathcal{M}^{\text{MHV}}(-l_2, r+1, \dots, s-1, l_3) \\ & \times \mathcal{M}^{\text{MHV}}(-l_3, s, \dots, t-1, l_4) \mathcal{M}^{\text{MHV}}(-l_4, t, \dots, r-1, l_1), \end{aligned} \quad (4.1)$$

where the three-point anti-MHV amplitude is given in (2.4). The MHV superamplitude may be written in terms of squares of Yang-Mills amplitudes times dressing factors using (3.7) and (3.8). What will be important in what follows is that in the

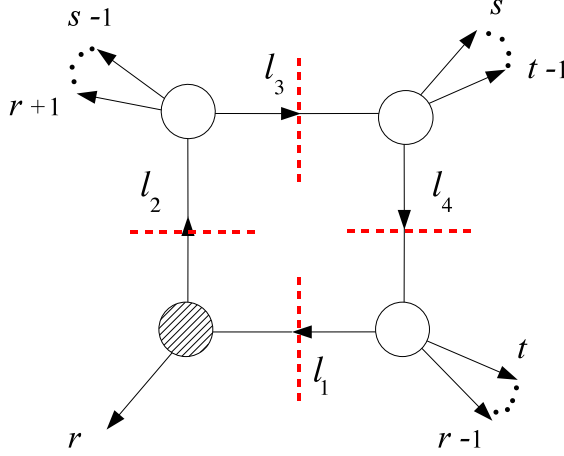

Figure 4: *The quadruple cut diagram determining the three-mass supercoefficient $\mathcal{C}^{\mathcal{N}=8}(r, P, Q, R)$ in the NMHV amplitudes in $\mathcal{N} = 8$ supergravity. There is a single three-point amplitude participating in the cut, with the anti-MHV helicity configuration. The remaining three superamplitudes are MHV's. We also define $P := \sum_{l=r+1}^{s-1} p_l$, $Q := \sum_{l=s}^{t-1} p_l$, and $R := \sum_{l=t}^{r-1} p_l$.*

sum over permutations in (3.7) there are always two missing legs. In applying this formula to write down explicitly the MHV superamplitudes entering the cut diagram in (4.1), we will arrange these two missing legs to be precisely the loop legs.

Since the dressing factors are independent of the superspace variables η , the fermionic integrations in (4.1) can then be done similarly to those for the SYM case in [29]. Only one of the two solutions to the cut equations contributes to the maximal cut diagram in Figure 4, hence we can drop the sum over \mathcal{S}_{\pm} in (4.1), which then becomes

$$\begin{aligned} \mathcal{C}_{3m}^{\mathcal{N}=8}(r, P, Q, R) &= \sum_{\mathcal{P}(P)} \sum_{\mathcal{P}(Q)} \sum_{\mathcal{P}(R)} (\mathcal{C}_{3m}^{\mathcal{N}=4}(r, P, Q, R))^2 \\ &\times 2 G^{\text{MHV}}(-l_2, P, l_3) G^{\text{MHV}}(-l_3, Q, l_4) G^{\text{MHV}}(-l_4, R, l_1), \end{aligned} \quad (4.2)$$

where

$$\mathcal{C}_{3m}^{\mathcal{N}=4}(r, P, Q, R) = \frac{\delta^{(8)}\left(\sum_{i=1}^n (\eta_i \lambda_i)\right) R_{r;st}}{\prod_j \langle j j+1 \rangle} \Delta_{r,r+1,s,t}, \quad (4.3)$$

is the corresponding Yang-Mills supercoefficient, calculated in [30]. The dual super-

conformal invariants $R_{r;st}$ are given by [27, 29]

$$R_{r;st} = \frac{\langle s-1s \rangle \langle t-1t \rangle \delta^{(4)}(\Xi_{r;st})}{x_{st}^2 \langle r|x_{rt}x_{ts}|s-1 \rangle \langle r|x_{rt}x_{ts}|s \rangle \langle r|x_{rs}x_{st}|t-1 \rangle \langle r|x_{rs}x_{st}|t \rangle}, \quad (4.4)$$

where

$$\Xi_{r;st} := \langle r | \left[x_{rs}x_{st} \sum_{k=t}^{r-1} |k\rangle \eta_k + x_{rt}x_{ts} \sum_{k=s}^{r-1} |k\rangle \eta_k \right], \quad (4.5)$$

and $x_{ab} := \sum_{l=a}^{b-1} p_l$. Finally,

$$\Delta_{r,r+1,s,t} = \frac{1}{2} (x_{rs}^2 x_{r+1t}^2 - x_{rt}^2 x_{r+1s}^2). \quad (4.6)$$

We have thus managed to express each three-mass coefficient as a sum of squares of SYM coefficients, weighted with bosonic dressing factors and summed over the appropriate permutations.

The product of three tree-level dressing factors in (4.2) can in principle be further simplified by inserting the explicit solution to the cut expression. The generic solution (when the four corners are massive) has been worked out in [31]. One can however find rather simple expressions in terms of spinor variables when at least one of the four amplitudes participating in the quadruple cut is a three-point amplitude. For the three-mass configuration, the quadruple cut solutions have been presented in [42, 43] in a compact form. For the specific case in Figure 4, where the three-point amplitude is anti-MHV, the solution is [42, 43]

$$\begin{aligned} l_1 &= \frac{|r\rangle \langle r|PQR|}{\langle r|PR|r\rangle}, & l_2 &= \frac{|r\rangle \langle r|RQP|}{\langle r|PR|r\rangle}, \\ l_3 &= \frac{|QRr\rangle \langle rP|}{\langle r|PR|r\rangle}, & l_4 &= \frac{|QP r\rangle \langle rR|}{\langle r|PR|r\rangle}, \end{aligned} \quad (4.7)$$

whereas the dressing factors are given by (3.8), which in this case gives

$$\begin{aligned} G^{\text{MHV}}(-l_2, \{P\}, l_3) &= s_{-l_2 r+1} \prod_{k=r+1}^{s-3} \frac{\langle k|x_{k,k+2}x_{k+2,l_3}|l_3\rangle}{\langle kl_3\rangle}, \\ G^{\text{MHV}}(-l_3, \{Q\}, l_4) &= s_{-l_3 s} \prod_{k=s}^{t-3} \frac{\langle k|x_{k,k+2}x_{k+2,l_4}|l_4\rangle}{\langle kl_4\rangle}, \\ G^{\text{MHV}}(-l_4, \{R\}, l_1) &= s_{-l_4 t} \prod_{k=s}^{r-3} \frac{\langle k|x_{k,k+2}x_{k+2,l_1}|l_1\rangle}{\langle kl_1\rangle}. \end{aligned} \quad (4.8)$$

We now turn to the two-mass hard coefficients. There are two quadruple cut diagrams contributing here. These are shown in Figure 5, where the two adjacent

three-point amplitudes are MHV and anti-MHV (or vice versa). Similarly to the $\mathcal{N} = 4$ case discussed in [29], these two diagrams can be regarded as special cases of the three-mass diagrams in Figure 4. The result for the first diagram is simply given by $\mathcal{C}_{3m}^{\mathcal{N}=8}(i, i+1, P, Q)$, whereas for the second one has $\mathcal{C}_{3m}^{\mathcal{N}=8}(i+1, i, Q, P)$, where $P := \{p_{i+2}, \dots, p_{r-1}\}$ and $Q := \{p_r, \dots, p_{i-1}\}$. The three-mass coefficients are defined in Figure 4. The two-mass hard coefficients are then equal to

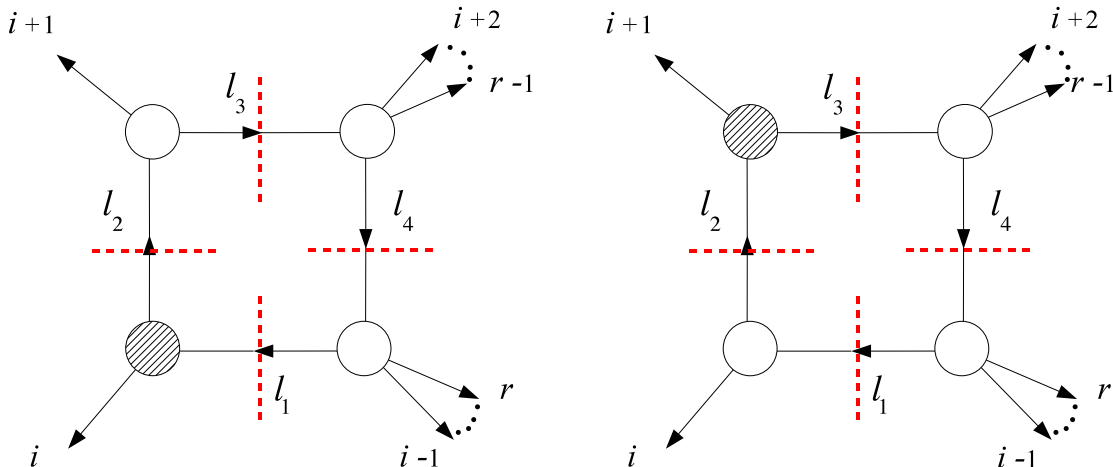

Figure 5: *The two quadruple cut diagrams determining the two-mass hard supercoefficient $\mathcal{C}^{\mathcal{N}=8}(i, j, P, Q)$ in the NMHV amplitudes in $\mathcal{N} = 8$ supergravity. Three-point amplitudes depicted in (black) white have the (anti-)MHV helicity configuration. The remaining two amplitudes are MHV's.*

$$\mathcal{C}_{2mh}^{\mathcal{N}=8}(i, i+1, P, Q) = \mathcal{C}_{3m}^{\mathcal{N}=8}(i, i+1, P, Q) + \mathcal{C}_{3m}^{\mathcal{N}=8}(i+1, i, Q, P). \quad (4.9)$$

We will present in Section 5.2 some numerical checks of (4.9) for the case of six-point NMHV superamplitudes, finding agreement with the results of [8, 9].

4.2 Two-mass-easy and one-mass coefficients

We now move on to consider the two-mass easy coefficients, and as a particular case of these, the one-mass coefficients. In the two-mass easy case there are two diagrams, as in the SYM case considered in [29], related to each other by a simple exchange of labels. Each cut diagram has two anti-MHV amplitudes, one NMHV amplitude and

one MHV amplitude, see Figure 6.²

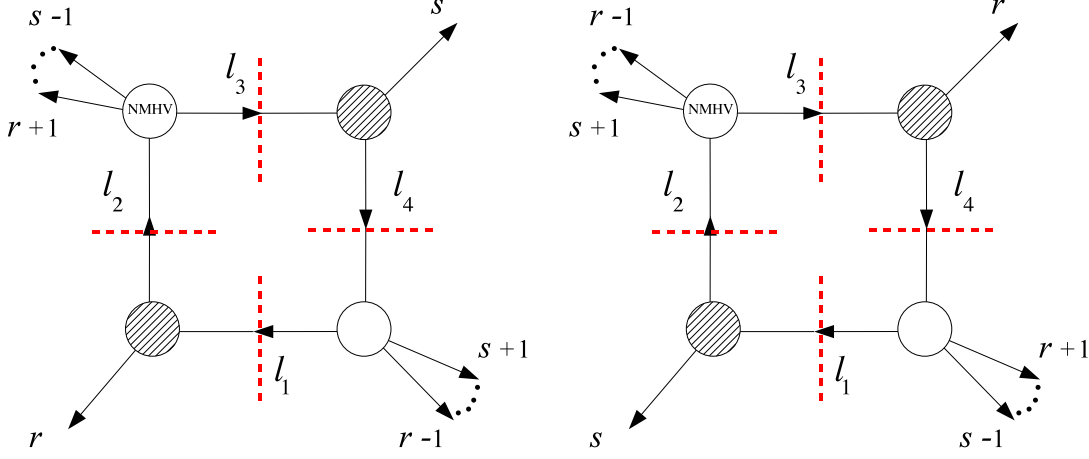

Figure 6: The two quadruple cut diagrams determining the two-mass easy supercoefficient $\mathcal{C}^{\mathcal{N}=8}(r, P, s, Q)$ in the NMHV amplitudes in $\mathcal{N} = 8$ supergravity. Three-point amplitudes have the anti-MHV helicity configuration, whereas the white amplitudes are MHV. We also define $P := \sum_{l=r+1}^{s-1} p_l$, and $Q := \sum_{l=s+1}^{r-1} p_l$.

Consider the first diagram. The result from the quadruple cut is

$$\begin{aligned} \mathcal{C}_{2\text{me}}^{\mathcal{N}=8}(r, P, s, Q) \Big|_1 &= \frac{1}{2} \sum_{S_{\pm}} \int \prod_{i=1}^4 d^8 \eta_i \mathcal{M}_3^{\overline{\text{MHV}}}(-l_1, r, l_2) \mathcal{M}^{\text{NMHV}}(-l_2, r+1, \dots, s-1, l_3) \\ &\times \mathcal{M}_3^{\overline{\text{MHV}}}(-l_3, s, l_4) \mathcal{M}^{\text{MHV}}(-l_4, s+1, \dots, r-1, l_1). \end{aligned} \quad (4.10)$$

Here we may use the expression for NMHV tree amplitudes given in [24], namely

$$\mathcal{M}^{\text{NMHV}}(1, \dots, n) = \sum_{\mathcal{P}(2, \dots, n-1)} M^{\text{NMHV}}(1, \dots, n), \quad (4.11)$$

where the ordered subamplitude $M^{\text{NMHV}}(1, \dots, n)$ is

$$M^{\text{NMHV}}(1, \dots, n) = [A^{\text{MHV}}(1, \dots, n)]^2 \sum_{i=2}^{n-3} \sum_{j=i+2}^{n-1} R_{n;ij}^2 G_{n;ij}^{\text{NMHV}}. \quad (4.12)$$

²An additional quadruple cut can actually be constructed by replacing one of the two three-point anti-MHV amplitude with a three-point MHV one, and compensating this by replacing further the NMHV amplitude by an MHV one. It can easily be shown [29] that this particular quadruple cut would lead to constraints on the external kinematics, and hence can be ignored.

The explicit expressions for the dressing factors $G_{n;ij}^{\text{NMHV}}$ are given in [24], and $R_{n;ij}$ are the dual superconformal invariants given in (4.4); a useful diagrammatic representation of these quantities was suggested in [29], and is reproduced for convenience here in Figure 7.

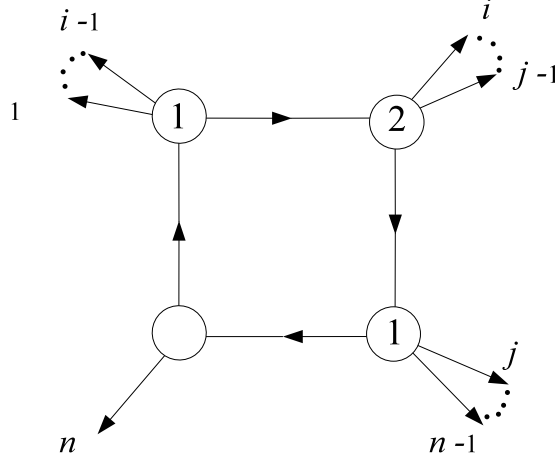

Figure 7: *Diagrammatic representation of the superconformal invariant $R_{n;ij}$. The numbers in the blobs indicate the minimum number of legs which need to be attached to that blob. From this Figure, it is easy to see that $\Xi_{n;ij}$ in (4.5) does not depend either on η_n and η_1 .*

The very important property of $R_{n;ij}$, which follows immediately from its definition (4.4) and from Figure 7, is that it does not depend either on η_n and η_1 . This observation simplifies drastically our calculation, and is eventually responsible for why we will be able to write the $\mathcal{N} = 8$ supercoefficients as sums of squares of SYM supercoefficients. Specifically, in writing explicitly the tree-level NMHV superamplitude $\mathcal{M}^{\text{NMHV}}(-l_2, p_{r+1}, \dots, p_{s-1}, l_3)$ in (4.10) using (4.11) and (4.12), we will pick the loop legs $-l_2$ and l_3 to be 1 and n appearing in the latter formulae. Two important consequences of this are that, firstly, the sum over permutations in (4.11) will not involve the cut-loop legs $-l_2$ and l_3 ; and, secondly, that the supermomenta $\eta_{l_2}\lambda_{l_2}$ and $\eta_{l_3}\lambda_{l_3}$ of the cut legs will appear only through the overall supermomentum conservation delta functions. Therefore, the fermionic integrations over η_{l_2} and η_{l_3} in (2.6) will proceed as in the case of the supergravity MHV superamplitude discussed previously.³

We now proceed with the calculation. Inserting (4.11) and (4.12) into (4.10),

³The same property was observed in the $\mathcal{N} = 4$ calculation of [30]. It is quite remarkable that this property continues to hold in maximal supergravity.

as well as the expressions for the three-point anti-MHV amplitude (2.4) and for the MHV amplitude in (3.7), we find

$$\begin{aligned}
\mathcal{C}_{2\text{me}}^{\mathcal{N}=8 \text{ (NMHV)}}(r, P, s, Q) &= \frac{1}{2} \sum_{S_{\pm}} \int \prod_{i=1}^4 d^8 \eta_i \left[A_3^{\overline{\text{MHV}}}(-l_1, r, l_2) \right]^2 \left[A_3^{\overline{\text{MHV}}}(-l_3, s, l_4) \right]^2 \\
&\times \sum_{\mathcal{P}(P)} \left(\left[A^{\text{MHV}}(-l_2, \{P\}, l_3) \right]^2 \sum_{i=r+1}^{s-3} \sum_{j=i+2}^{s-1} (R_{l_3;ij})^2 G_{l_3;ij}^{\text{NMHV}} \right) \\
&\times \sum_{\mathcal{P}(Q)} \left[A^{\text{MHV}}(-l_4, \{Q\}, l_1) \right]^2 G^{\text{MHV}}(-l_4, \{Q\}, l_1) + r \leftrightarrow s, \tag{4.13}
\end{aligned}$$

where the first ($r \leftrightarrow s$) term in (4.13) corresponds to the cut diagram on the left (right) of Figure 6. By $\{P\}$, $\{Q\}$, we mean the (ordered) sets of momenta $(p_{r+1}, \dots, p_{s-1})$, and $(p_{s+1}, \dots, p_{r-1})$.

Next we observe that only one of the two cut solutions contributes, namely the solution in (3.13). We can then recast (4.13) as

$$\begin{aligned}
\mathcal{C}_{2\text{me}}^{\mathcal{N}=8 \text{ (NMHV)}}(r, P, s, Q) &= 2 \sum_{\mathcal{P}(\{P\})} \sum_{\mathcal{P}(\{Q\})} \left[\mathcal{C}_{2\text{me}}^{\mathcal{N}=4 \text{ (MHV)}}(r, P, s, Q) \right]^2 \tag{4.14} \\
&\times \left(\sum_{i=r+1}^{s-3} \sum_{j=i+2}^{s-1} (R_{l_3;ij})^2 G_{l_3;ij}^{\text{NMHV}} \right) G^{\text{MHV}}(-l_4, Q, l_1) + r \leftrightarrow s.
\end{aligned}$$

The dual superconformal invariant R -function appearing in (4.14) is given by (4.4). Explicitly,

$$R_{l_3;ij} = \frac{\langle i-1i \rangle \langle j-1j \rangle \delta^{(4)}(\Xi_{l_3;ij})}{x_{ij}^2 \langle l_3 | x_{r+1,i} x_{ij} | j \rangle \langle l_3 | x_{r+1,i} x_{ij} | j-1 \rangle \langle l_3 | x_{r+1,j} x_{ji} | i \rangle \langle l_3 | x_{r+1,j} x_{ji} | i-1 \rangle}, \tag{4.15}$$

where

$$\Xi_{l_3;ij} = -\langle l_3 | \left(x_{r+1,i} x_{ij} \sum_{m=j}^{s-1} |m\rangle \eta_m + x_{r+1,j} x_{ji} \sum_{m=i}^{s-1} |m\rangle \eta_m \right). \tag{4.16}$$

A few comments are in order here.

Firstly, we need to insert the cut solutions into the previous expressions. These are obtained from (3.13) by just replacing $1 \rightarrow r$. Furthermore, when the minimum value of i , i.e. $i = r + 1$ is attained in the sum appearing in (4.14), the corresponding spinor for $i - 1$ is actually $|i - 1\rangle \equiv |-l_2\rangle$, since the R -function comes from the NMHV amplitude with legs $(-l_2, r + 1, \dots, s - 1, l_3)$. However, the expression for R in (4.15) is invariant under rescalings of $|i - 1\rangle$. Hence, since $|l_2\rangle \propto |r\rangle$ because of the cut condition, we conclude that we can set $|i - 1\rangle \rightarrow |r\rangle$ when the minimum value in the sum over i in (4.14) is attained.

Furthermore, we notice that $|l_3\rangle \propto |s\rangle$ because of the cut condition. By expanding the fermionic delta function $\delta^{(4)}(\Xi_{l_3;ij})$ we see that this will contribute four powers of $\langle l_3|$; inspecting (4.15), we conclude that $R_{l_3,ij}$ will eventually be invariant under rescalings of $\langle l_3|$ as well. We can then replace $\langle l_3| \rightarrow \langle s|$ inside the expression for $R_{l_3;ij}$ or, equivalently, $R_{l_3;ij} \rightarrow R_{s;ij}$ and $\Xi_{l_3;ij} \rightarrow \Xi_{s;ij}$, so that the explicit loop solutions are not present in these quantities.

Taking into account the previous remarks, we arrive at

$$\begin{aligned} \mathcal{C}_{2me}^{\mathcal{N}=8 \text{ (NMHV)}}(r, P, s, Q) &= 2 \sum_{\mathcal{P}(P)} \sum_{\mathcal{P}(Q)} \left[\mathcal{C}_{2me}^{\mathcal{N}=4 \text{ (MHV)}}(r, P, s, Q) \right]^2 \\ &\times \left(\sum_{i=r+1}^{s-3} \sum_{j=i+2}^{s-1} (R_{s;ij})^2 G_{l_3;ij}^{\text{NMHV}} \right) G^{\text{MHV}}(-l_4, Q, l_1) + r \leftrightarrow s . \end{aligned} \quad (4.17)$$

The general expressions for the MHV dressing factors are given in (3.8), from which one can obtain $G^{\text{MHV}}(-l_4, Q, l_1)$.

Finally we consider one-mass coefficients. As explained in [29] in the Yang-Mills case, the two relevant diagrams are special cases of other diagrams. In the first of them, the three three-point corners are MHV- $\overline{\text{MHV}}$ -MHV and the fourth corner is MHV, which is a special case of the NMHV $2me$ coefficient. In the second diagram, the three three-point corners are $\overline{\text{MHV}}$ -MHV- $\overline{\text{MHV}}$ and the fourth corner is NMHV, which is a special case of the NMHV three-mass coefficient. Therefore, one finds

$$\mathcal{C}_{1m}^{\mathcal{N}=8}(s+2, P, s, s+1) = \mathcal{C}_{2me}^{\mathcal{N}=8}(s+2, P, s, s+1) + \mathcal{C}_{3m}^{\mathcal{N}=8}(s+1, s+2, P, s) . \quad (4.18)$$

5 Examples

In order to illustrate and test the above expressions for the one-loop integral supercoefficients, we can compare these with known cases.

5.1 Five-point NMHV superamplitude

The simplest case is the five-point NMHV superamplitude. Here the relevant cut diagram we consider is depicted in Figure 8.

The cut solution is:

$$l_1 = \lambda_{l_1} \tilde{\lambda}_1 , \quad l_2 = \lambda_{l_2} \tilde{\lambda}_2 , \quad l_3 = \lambda_{l_3} \tilde{\lambda}_3 , \quad l_4 = \lambda_{l_4} \tilde{\lambda}_4 , \quad (5.1)$$

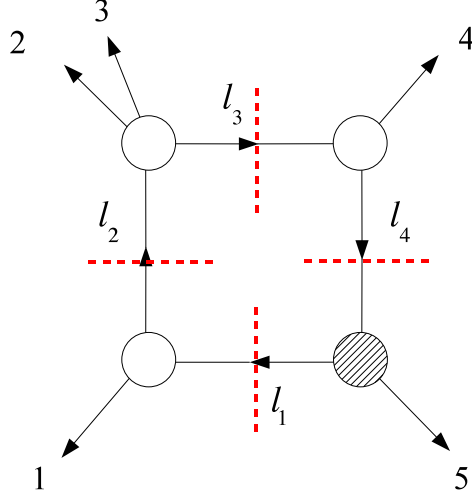

Figure 8: A quadruple cut diagram determining the supercoefficient $\mathcal{C}(1, \{23\}, 4, 5)$ in the five-point anti-MHV superamplitudes in $\mathcal{N} = 4$ SYM and $\mathcal{N} = 8$ supergravity. The black three-point amplitude has the anti-MHV configuration, and the remaining two amplitudes are MHV's.

and $\lambda_{l_1}, \dots, \lambda_{l_4}$ are again easily determined by imposing momentum conservation at the four corners of the cut diagram. The result is

$$\lambda_{l_1} = -\frac{Q|4]}{[14]}, \quad \lambda_{l_2} = \frac{Q|1]}{[41]}, \quad \lambda_{l_3} = -\frac{P|1]}{[41]}, \quad \lambda_{l_4} = \frac{P|4]}{[14]}, \quad (5.2)$$

which is valid for a generic two-mass easy configuration, i.e. for P and Q non null. In the specific case of Figure 8, we have $P = p_2 + p_3$ and $Q = p_5$.

It is instructive to first consider the $\mathcal{N} = 4$ SYM calculation in this case as the manipulations are very similar. Here the amplitude supercoefficient is given by the following fermionic integral,

$$\begin{aligned} \mathcal{C}^{\mathcal{N}=4}(1, \{2, 3\}, 4, 5) &= \frac{1}{2} \sum_{\mathcal{S}_{\pm}} \int \prod_{i=1}^4 d^4 \eta_i A_3^{\text{MHV}}(-l_1, 1, l_2) A_4^{\text{MHV}}(-l_2, 2, 3, l_3) \\ &\quad \times A_3^{\text{MHV}}(-l_3, 4, l_4) A_3^{\overline{\text{MHV}}}(-l_4, 5, l_1), \end{aligned} \quad (5.3)$$

where [6, 25]

$$A_3^{\overline{\text{MHV}}}(-l_4, 5, l_1) = \frac{\delta^{(4)}(\eta_4[5l_1] + \eta_5[l_1l_4] + \eta_1[l_45])}{[l_45][5l_1][l_1l_4]}, \quad (5.4)$$

and the MHV superamplitudes are given by the usual formula (3.3). As in previous cases, there is only one solution to the cut equation for this amplitude, given in (5.1) and (5.2). Let us consider the fermionic integrations arising from (5.3). These give

$$\begin{aligned} & \int \prod_{i=1}^4 d^4 \eta_i \delta^{(8)}(-\eta_{l_1} \lambda_{l_1} + \eta_{l_2} \lambda_{l_2} + \eta_1 \lambda_1) \delta^{(8)}(-\eta_{l_2} \lambda_{l_2} + \eta_{l_3} \lambda_{l_3} + \eta_2 \lambda_2 + \eta_3 \lambda_3) \\ & \quad \times \delta^{(8)}(-\eta_{l_3} \lambda_{l_3} + \eta_{l_4} \lambda_{l_4} + \eta_4 \lambda_4) \delta^{(4)}(\eta_{l_4} [5l_1] + \eta_5 [l_1 l_4] + \eta_{l_1} [l_4 5]) \\ & = \left(\frac{\langle 15 \rangle \langle 23 \rangle [15] [45]}{[14]^2} \right)^4 \delta^{(8)} \left(\sum_{i=1}^5 \eta_i \lambda_i \right) \delta^{(4)}(\eta_1 [23] + \eta_2 [31] + \eta_3 [12]), \end{aligned} \quad (5.5)$$

where we have used the cut solution (5.1) and (5.2).

The contribution of the spinor factors arising from (5.3) is readily evaluated to be

$$\frac{[14]^8}{\langle 23 \rangle^4 \langle 15 \rangle [15] \langle 45 \rangle [45]^3 \bar{N}}, \quad (5.6)$$

where $\bar{N} := [12][23][34][45][51]$. Putting this together with the contribution from fermionic integrations we arrive at the following result for the quadruple cut:

$$\mathcal{C}^{\mathcal{N}=4}(1, \{2, 3\}, 4, 5) = \frac{1}{2} \delta^{(8)} \left(\sum_{i=1}^5 \eta_i \lambda_i \right) \frac{\delta^{(4)}(\eta_1 [23] + \eta_2 [31] + \eta_3 [12])}{\bar{N} \langle 45 \rangle^4} s_{15} s_{45}. \quad (5.7)$$

We recall that the five-point tree-level anti-MHV amplitude is [29]

$$A_5^{\overline{\text{MHV}}}(1, 2, 3, 4, 5) = \delta^{(8)} \left(\sum_{i=1}^5 \eta_i \lambda_i \right) \frac{\delta^{(4)}(\eta_1 [23] + \eta_2 [31] + \eta_3 [12])}{\bar{N} \langle 45 \rangle^4}, \quad (5.8)$$

from which we conclude that the the supercoefficient is given by

$$\mathcal{C}^{\mathcal{N}=4}(1, \{2, 3\}, 4, 5) = \frac{s_{15} s_{45}}{2} A_5^{\overline{\text{MHV}}}(1, 2, 3, 4, 5), \quad (5.9)$$

which is the expected result.

The expression for the supercoefficient $\mathcal{C}^{\mathcal{N}=8}(1, \{2, 3\}, 4, 5)$ in the case of $\mathcal{N} = 8$ supergravity is again obtained by looking at the quadruple cut depicted in Figure 8, which in this case is

$$\begin{aligned} \mathcal{C}^{\mathcal{N}=8}(1, \{2, 3\}, 4, 5) & = \frac{1}{2} \sum_{S_{\pm}} \int \prod_{i=1}^4 d^8 \eta_i \mathcal{M}_3^{\text{MHV}}(-l_1, 1, l_2) \mathcal{M}_4^{\text{MHV}}(-l_2, 2, 3, l_3) \\ & \quad \times \mathcal{M}_3^{\text{MHV}}(-l_3, 4, l_4) \mathcal{M}_3^{\overline{\text{MHV}}}(-l_4, 5, l_1), \end{aligned} \quad (5.10)$$

where

$$\begin{aligned}\mathcal{M}_3^{\text{MHV}}(-l_1, 1, l_2) &= (A_3^{\text{MHV}}(-l_1, 1, l_2))^2, \\ \mathcal{M}_3^{\overline{\text{MHV}}}(-l_4, 5, l_1) &= (A_3^{\overline{\text{MHV}}}(-l_4, 5, l_1))^2,\end{aligned}\tag{5.11}$$

and the four-point MHV superamplitudes is, using (3.7),

$$\mathcal{M}_4^{\text{MHV}}(-l_2, 2, 3, l_3) = s_{-l_2 2} (A_4^{\text{MHV}}(-l_2, 2, 3, l_3))^2 + s_{-l_2 3} (A_4^{\text{MHV}}(-l_2, 3, 2, l_3))^2.\tag{5.12}$$

We can then recast $\mathcal{C}^{\mathcal{N}=8}(1, \{2, 3\}, 4, 5)$ as the sum of two terms,

$$\mathcal{C}^{\mathcal{N}=8}(1, \{2, 3\}, 4, 5) := \mathcal{C}(1, \{2, 3\}, 4, 5) + \mathcal{C}(1, \{3, 2\}, 4, 5),\tag{5.13}$$

corresponding to the two terms in the sum in (5.12). Each of these two terms is instantly obtained from the corresponding result in Yang-Mills, we only have to calculate the dressing factors

$$\begin{aligned}G(-l_2, 2, 3, l_3) &:= s_{-l_2 2} = [12] \frac{\langle 23 \rangle [34]}{[14]} = \frac{\text{Tr}_+(1234)}{s_{14}}, \\ G(-l_2, 3, 2, l_3) &:= s_{-l_2 3} = [13] \frac{\langle 32 \rangle [24]}{[14]} = \frac{\text{Tr}_+(1324)}{s_{14}},\end{aligned}\tag{5.14}$$

using the explicit cut solution.

We can then write

$$\mathcal{C}^{\mathcal{N}=8}(1, \{2, 3\}, 4, 5) = \frac{1}{2} \left(s_{15} s_{45} A_5^{\overline{\text{MHV}}}(1, 2, 3, 4, 5) \right)^2 \frac{\text{Tr}_+(1234)}{s_{14}},\tag{5.15}$$

or, for the coefficient of the pseudo-conformally invariant box function (obtained from the previous one by dividing by $-s_{15}s_{45}/2$),

$$\hat{\mathcal{C}}^{\mathcal{N}=8}(1, \{2, 3\}, 4, 5) = - \left(A_5^{\overline{\text{MHV}}}(1, 2, 3, 4, 5) \right)^2 \text{Tr}_+(1234) \frac{s_{15}s_{45}}{s_{14}}.\tag{5.16}$$

A similar analysis applies for the coefficient of $\mathcal{C}^{\mathcal{N}=8}(1, \{3, 2\}, 4, 5)$. We can now recast the supergravity coefficient (5.13) as a sum of squares of Yang-Mills coefficients, as

$$\begin{aligned}\mathcal{C}^{\mathcal{N}=8}(1, \{2, 3\}, 4, 5) &= 2 \left(\mathcal{C}^{\mathcal{N}=4}(1, \{2, 3\}, 4, 5) \right)^2 \frac{\text{Tr}_+(1234)}{s_{14}} \\ &+ 2 \left(\mathcal{C}^{\mathcal{N}=4}(1, \{3, 2\}, 4, 5) \right)^2 \frac{\text{Tr}_+(1324)}{s_{14}}.\end{aligned}\tag{5.17}$$

We now wish to compare with the known results for the $\mathcal{N} = 8$ supergravity amplitude. The sum in (5.13) gives, modulo an overall common factor,

$$\frac{1}{[12][34]} - \frac{1}{[13][24]} = \frac{[14][32]}{[12][13][24][34]},\tag{5.18}$$

and we recognise that our present manipulations are the complex conjugate of those leading to (3.21), in particular

$$\sum_{\mathcal{P}(23)} \frac{G(-l_2, 2, 3, l_3)}{([12][23][34])^2} = \frac{\langle 23 \rangle}{[14][23]^2} \frac{[14][32]}{[12][13][24][34]} = \frac{\langle 23 \rangle}{[23]} \frac{1}{[12][24][13][34]}, \quad (5.19)$$

which is the complex conjugate of $h(1, \{2, 3\}, 4)$. Hence we can also write

$$\begin{aligned} \mathcal{C}^{\mathcal{N}=8}(1, \{2, 3\}, 4, 5) &= \left(s_{15} s_{45} \delta^{(8)} \left(\sum_{i=1}^5 \eta_i \lambda_i \right) \frac{\delta^{(4)}(\eta_1[23] + \eta_2[31] + \eta_3[12])}{[45][51]\langle 45 \rangle^4} \right)^2 \\ &\times \sum_{\mathcal{P}(23)} \frac{G(-l_2, 2, 3, l_3)}{([12][23][34])^2} \\ &= \left[s_{15} s_{45} \delta^{(8)} \left(\sum_{i=1}^5 \eta_i \lambda_i \right) \frac{\delta^{(4)}(\eta_1[23] + \eta_2[31] + \eta_3[12])}{\langle 45 \rangle^4} \right]^2 \\ &\times \bar{h}(1, \{2, 3\}, 4) \bar{h}(4, \{5\}, 1), \end{aligned} \quad (5.20)$$

where we have also introduced $\bar{h}(4, \{5\}, 1) = 1/([45][51])^2$. Equation (5.20) is in agreement with the results of [7].

5.2 Six-point NMHV superamplitude

In this section we will consider (4.9) in the case of six-point NMHV superamplitudes, and perform some numerical checks comparing our results to those derived in [8, 9] for six-point NMHV graviton scattering amplitudes. Specifically, we will compare our results to the following coefficients derived in [8, 9]:

$$\begin{aligned} \mathcal{C}_{2\text{mh}}^{\mathcal{N}=8}(1^+, 2^-, \{3^-, 4^-\}, \{5^+, 6^+\}) &= \\ \frac{1}{2} \frac{s_{34} s_{56} s_{12}^2 (x_{25}^2)^8}{[23][34][24][43]\langle 56 \rangle \langle 61 \rangle \langle 65 \rangle \langle 51 \rangle [2|x_{25}|5][2|x_{25}|6][3|x_{25}|1][4|x_{25}|1]}, \end{aligned} \quad (5.21)$$

and

$$\begin{aligned} \mathcal{C}_{2\text{mh}}^{\mathcal{N}=8}(3^+, 4^-, \{5^+, 6^+\}, \{1^-, 2^-\}) &= \\ \frac{1}{2} \frac{([3|x_{14}|4])^8 s_{12} s_{56} (s_{34})^2}{\langle 45 \rangle \langle 46 \rangle \langle 56 \rangle \langle 65 \rangle [12][13][21][23][1|x_{14}|4][2|x_{14}|4][3|x_{14}|5][3|x_{14}|6]} \\ + \frac{1}{2} \frac{\langle 12 \rangle^6 [56]^6 s_{12} s_{56} s_{34}^2}{\langle 13 \rangle \langle 23 \rangle [45][46][4|x_{14}|1][4|x_{14}|2][5|x_{14}|3][6|x_{14}|3]}. \end{aligned} \quad (5.22)$$

At six points, (4.9) is

$$\mathcal{C}_{2\text{mh}}^{\mathcal{N}=8}(i, i+1, P, Q) = \mathcal{C}_{3\text{m}}^{\mathcal{N}=8}(i, i+1, P, Q) + \mathcal{C}_{3\text{m}}^{\mathcal{N}=8}(i+1, P, Q, i), \quad (5.23)$$

where $P = p_{i+2} + p_{i+3}$ and $Q = p_{i+4} + p_{i+5}$. The three-mass supercoefficients given in (4.2) become in this case

$$\begin{aligned} \mathcal{C}_{3m}^{\mathcal{N}=8}(i, i+1, P, Q) &= \sum_{\mathcal{P}(P)} \sum_{\mathcal{P}(Q)} (\mathcal{C}_{3m}^{\mathcal{N}=4}(i, i+1, P, Q))^2 \\ &\times 2 \frac{\langle i+2|PQ|i\rangle \langle i|i+1|i+2\rangle}{\langle i|(i+1)Q|i\rangle} \frac{\langle i+4|P(i+1)|i\rangle \langle i|Q|i+4\rangle}{\langle i|(i+1)Q|i\rangle}, \end{aligned} \quad (5.24)$$

and

$$\begin{aligned} \mathcal{C}_{3m}^{\mathcal{N}=8}(i+1, P, Q, i) &= \sum_{\mathcal{P}(P)} \sum_{\mathcal{P}(Q)} (\mathcal{C}_{3m}^{\mathcal{N}=4}(i+1, P, Q, i))^2 \\ &\times 2 \frac{\langle (i+2)(i+1)\rangle \langle i+1|iQPi+2\rangle}{\langle i+1|Pi|i+1\rangle} \frac{\langle i+4|Qi|i+1\rangle \langle i+1|Pi+4\rangle}{\langle i+1|Pi|i+1\rangle}, \end{aligned} \quad (5.25)$$

where dressing factors involving one external leg are equal to one, and the general expression for the $\mathcal{N} = 4$ three-mass supercoefficient entering (5.24) and (5.25) is given in (4.3). Thus, we arrive at

$$\begin{aligned} \mathcal{C}_{2mh}^{\mathcal{N}=8}(i, i+1, P, Q) &= \sum_{\mathcal{P}(P)} \sum_{\mathcal{P}(Q)} \\ &\left[\left(\frac{\delta^{(8)}(\sum_{i=1}^n \eta_i \lambda_i) R_{i,i+2,i+4}}{\prod_j \langle jj+1\rangle} \Delta_{i,i+1,i+2,i+4} \right)^2 \right. \\ &\times 2 \frac{\langle i+2|PQ|i\rangle \langle i|i+1|i+2\rangle}{\langle i|(i+1)Q|i\rangle} \frac{\langle i+4|P(i+1)|i\rangle \langle i|Q|i+4\rangle}{\langle i|(i+1)Q|i\rangle} \\ &+ \left(\frac{\delta^{(8)}(\sum_{i=1}^n \eta_i \lambda_i) R_{i+1,i+4,i}}{\prod_j \langle jj+1\rangle} \Delta_{i+1,i+2,i+4,i} \right)^2 \\ &\left. \times 2 \frac{\langle (i+2)(i+1)\rangle \langle i+1|iQPi+2\rangle}{\langle i+1|Pi|i+1\rangle} \frac{\langle i+4|Qi|i+1\rangle \langle i+1|Pi+4\rangle}{\langle i+1|Pi|i+1\rangle} \right]. \end{aligned} \quad (5.26)$$

In order to be able to extract the coefficients for graviton amplitudes, we need to analyse the η -dependence of the R -functions in (5.26). The dependence on the supermomenta of the external particles is contained in the product $[\delta^{(4)}(\Xi_{r;st})\delta^{(8)}(q)]^2$. Since we are going to compare to NMHV graviton amplitudes, we will only need the coefficients of terms of the form $(\eta_i)^8(\eta_j)^8(\eta_k)^8$.

Consider now the helicity assignment for the coefficient in (5.21). In (5.26), we encounter the quantities $\Xi_{i,i+2,i+4}$ and $\Xi_{i+1,i+4,i+6}$. Therefore, we consider the expressions $\delta^{(8)}(\Xi_{1;35})\delta^{(16)}(q)$ and $\delta^{(8)}(\Xi_{2;51})\delta^{(16)}(q)$. From (4.5), we have, setting $i = 1$,

$$\Xi_{1;35} = \langle 1|(5+6)4|3\rangle\eta_3 + \langle 1|(5+6)4|4\rangle\eta_4 + \langle 34|34\rangle\langle 15\rangle\eta_5 + \langle 34|34\rangle\langle 16\rangle\eta_6, \quad (5.27)$$

and

$$\Xi_{2;51} = \langle 21 \rangle \langle 56 \rangle ([61]\eta_5 + [15]\eta_6 + [56]\eta_1). \quad (5.28)$$

In the expansion of

$$\delta^{(8)}(\Xi_{1;35}) \delta^{(16)}\left(\sum_{i=1}^6 \eta_i \lambda_i\right), \quad (5.29)$$

we need to pick the coefficient of $(\eta_2)^8(\eta_3)^8(\eta_4)^8$, which is:

$$(\langle 1|5 + 6|3 + 4|2 \rangle \langle 43 \rangle)^8, \quad (5.30)$$

and in the expansion of

$$\delta^{(8)}([61]\eta_5 + [15]\eta_6 + [51]\eta_1) \delta^{(16)}\left(\sum_{i=1}^6 \eta_i \lambda_i\right), \quad (5.31)$$

the coefficient of $(\eta_2)^8(\eta_3)^8(\eta_4)^8$ vanishes. In performing the sum in (5.26) one will also need to include permutations of the above quantities.

Now we turn to the coefficient in (5.22) and compare to (5.26). In considering (5.26) for this helicity assignment, we encounter the quantities $\Xi_{3;51}$ and $\Xi_{4;13}$. These can be simply obtained by permuting indices in the expressions for $\Xi_{1;35}$ and $\Xi_{2;51}$ given above. The corresponding coefficients for $(\eta_1)^8(\eta_2)^8(\eta_4)^8$ are:

$$(\langle 12 \rangle \langle 34 \rangle s_{56})^8, \quad (5.32)$$

from $\Xi_{3;51}$, and

$$\langle 4|1 + 2|3 \rangle^8, \quad (5.33)$$

from $\Xi_{4;13}$.

Now we compare (5.21) and (5.22) to the expansions of $\mathcal{C}_{2\text{mh}}^{\mathcal{N}=8}(1, 2, \{3, 4\}, \{5, 6\})$ and $\mathcal{C}_{2\text{mh}}^{\mathcal{N}=8}(3, 4, \{5, 6\}, \{1, 2\})$ which one derives from (5.26). Summing over the appropriate permutations, we get

$$\begin{aligned} \mathcal{C}_{2\text{mh}}^{\mathcal{N}=8}(1^+, 2^-, \{3^-, 4^-\}, \{5^+, 6^+\}) &= \frac{\langle 34 \rangle^3 [56] \langle 1|(5+6)(3+4)|2 \rangle^6 (s_{12}s_{234})^2}{2 \langle 12 \rangle^6 \langle 56 \rangle^2 \langle 1|5+6|2 \rangle^2 (s_{34})^2} \\ &\times \left[\frac{1}{\langle 16 \rangle [23] \langle 5|3+4|2 \rangle \langle 1|5+6|4 \rangle} + \frac{1}{\langle 51 \rangle [23] \langle 6|3+4|2 \rangle \langle 1|5+6|4 \rangle} \right. \\ &\left. + \frac{1}{\langle 61 \rangle [24] \langle 5|3+4|2 \rangle \langle 1|5+6|3 \rangle} + \frac{1}{\langle 15 \rangle [24] \langle 6|3+4|2 \rangle \langle 1|5+6|3 \rangle} \right], \quad (5.34) \end{aligned}$$

and

$$\begin{aligned}
\mathcal{C}_{2\text{mh}}^{\mathcal{N}=8}(3^+, 4^-, \{5^+, 6^+\}, \{1^-, 2^-\}) &= -\frac{\langle 34 \rangle^4 [34]^2 (s_{456})^2}{2 \langle 3 | (1+2) (5+6) | 4 \rangle^2} \times \\
&\left[\frac{\langle 12 \rangle^6 [12] \langle 56 \rangle [56]^6}{\langle 3 | 1+2 | 4 \rangle^2} \times \right. \\
&\quad \left(\frac{1}{\langle 23 \rangle [45] \langle 1 | 5+6 | 4 \rangle \langle 3 | 1+2 | 6 \rangle} - \frac{1}{\langle 13 \rangle [45] \langle 2 | 5+6 | 4 \rangle \langle 3 | 1+2 | 6 \rangle} \right. \\
&\quad \left. - \frac{1}{\langle 23 \rangle [46] \langle 1 | 5+6 | 4 \rangle \langle 3 | 1+2 | 5 \rangle} + \frac{1}{\langle 13 \rangle [46] \langle 2 | 5+6 | 4 \rangle \langle 3 | 1+2 | 5 \rangle} \right) \\
&\quad + \frac{\langle 12 \rangle [56] \langle 4 | 1+2 | 3 \rangle^6}{\langle 56 \rangle^2 [12]^2} \times \\
&\quad \left(\frac{1}{\langle 45 \rangle [23] \langle 4 | 5+6 | 1 \rangle \langle 6 | 1+2 | 3 \rangle} - \frac{1}{\langle 45 \rangle [13] \langle 4 | 5+6 | 2 \rangle \langle 6 | 1+2 | 3 \rangle} \right. \\
&\quad \left. - \frac{1}{\langle 46 \rangle [23] \langle 4 | 5+6 | 1 \rangle \langle 5 | 1+2 | 3 \rangle} + \frac{1}{\langle 46 \rangle [13] \langle 4 | 5+6 | 2 \rangle \langle 5 | 1+2 | 3 \rangle} \right) \Big]. \quad (5.35)
\end{aligned}$$

We have checked numerically that (5.34) and (5.35) agree with (5.21) and (5.22), respectively.

6 General supergravity amplitudes

Let us now consider going beyond NMHV. For the N^2 MHV amplitudes we seek degree 16 (for $\mathcal{N} = 4$ SYM) or degree 32 (for $\mathcal{N} = 8$ supergravity) contributions which leads to the following possibilities for the four tree amplitudes entering into the quadruple cuts: one can have four MHV amplitudes, leading to four-mass, three-mass and two-mass coefficients, or two MHV amplitudes, one anti-MHV amplitude and one NMHV amplitude, leading to three-mass and two-mass hard coefficients, or two NMHV and two anti-MHV amplitudes leading to two-mass easy coefficients, or finally one can have one MHV amplitude, two anti-MHV amplitudes and one N^2 MHV amplitude, leading to the two-mass easy and one-mass coefficients.

For the four-mass coefficients, the obvious quadruple cut diagram, represented in Figure 9, has four MHV tree-level superamplitudes, and is given by

$$\begin{aligned}
\mathcal{C}_{4\text{m}}^{\mathcal{N}=8}(P, Q, R, S) &= \frac{1}{2} \sum_{\mathcal{S}_{\pm}} \int \prod_{i=1}^4 d^8 \eta_i \mathcal{M}^{\text{MHV}}(-l_1, P, l_2) \mathcal{M}^{\text{MHV}}(-l_2, Q, l_3) \\
&\quad \times \mathcal{M}^{\text{MHV}}(-l_3, R, l_4) \mathcal{M}^{\text{MHV}}(-l_4, S, l_1). \quad (6.1)
\end{aligned}$$

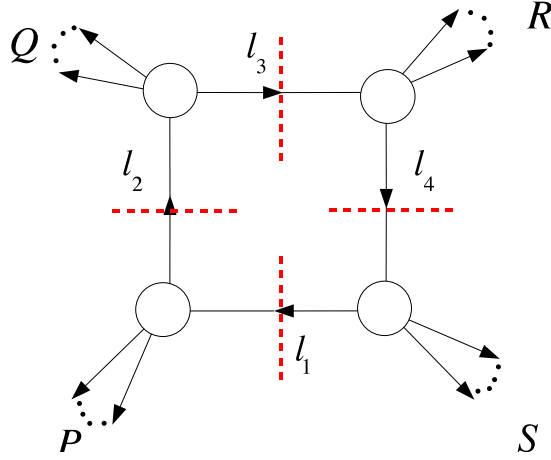

Figure 9: A quadruple cut diagram determining the four-mass supercoefficient in an N^2 MHV amplitude. The four tree-level superamplitudes entering the cut have the MHV configuration.

Using (3.7) this is equal to

$$\begin{aligned}
& \frac{1}{2} \sum_{S_{\pm}} \int \prod_{i=1}^4 d^8 \eta_i \sum_{\mathcal{P}(P,Q,R,S)} [A^{\text{MHV}}(-l_1, P, l_2)]^2 G^{\text{MHV}}(-l_1, P, l_2) \\
& \quad \times [A^{\text{MHV}}(-l_2, Q, l_3)]^2 G^{\text{MHV}}(-l_2, Q, l_3) [A^{\text{MHV}}(-l_3, R, l_4)]^2 G^{\text{MHV}}(-l_3, R, l_4) \\
& \quad \times [A^{\text{MHV}}(-l_4, S, l_1)]^2 G^{\text{MHV}}(-l_4, S, l_1) , \tag{6.2}
\end{aligned}$$

where the sum $\sum_{\mathcal{P}(P,Q,R,S)}$ is over permutations of momenta within each of the sets of momenta P , Q , R and S . Since the dressing factors G are independent of the superspace variables η , the superspace integrals will only act on the square of the product of the four tree MHV superamplitudes in the expression above. This is the same calculation as (the square of) the corresponding $\mathcal{N} = 4$ Yang-Mills four-mass coefficient, and hence one deduces that

$$\begin{aligned}
\mathcal{C}_{4\text{m}}^{\mathcal{N}=8}(P, Q, R, S) &= \frac{1}{2} \sum_{S_{\pm}} \sum_{\mathcal{P}(P,Q,R,S)} (\mathcal{P}_{n;1}^{4\text{m}})^2 G^{\text{MHV}}(-l_1, P, l_2) \\
& \quad \times G^{\text{MHV}}(-l_2, Q, l_3) G^{\text{MHV}}(-l_3, R, l_4) G^{\text{MHV}}(-l_4, S, l_1) , \tag{6.3}
\end{aligned}$$

where $\mathcal{P}_{n;1}^{4\text{m}}$ is the coefficient function given in equation (5.11) of [29] (this depends on the external momenta and in addition on the loop variables l_i , the solutions for which must be substituted).

A comment is in order here. We observe that, in contradistinction with the coefficients considered so far, because of the presence in (6.3) of a sum over the two solutions, we cannot recast immediately the right-hand side of this equation in terms of squares of $\mathcal{N} = 4$ supercoefficients; this appears to be a general feature of four-mass box coefficients.

For the three-mass case, we have two possibilities. The first one corresponds to a special case of a four-mass coefficient, where one of the four tree superamplitudes in Figure 9 is a three-point MHV amplitude. In addition, there are three new diagrams, represented in Figure 10.

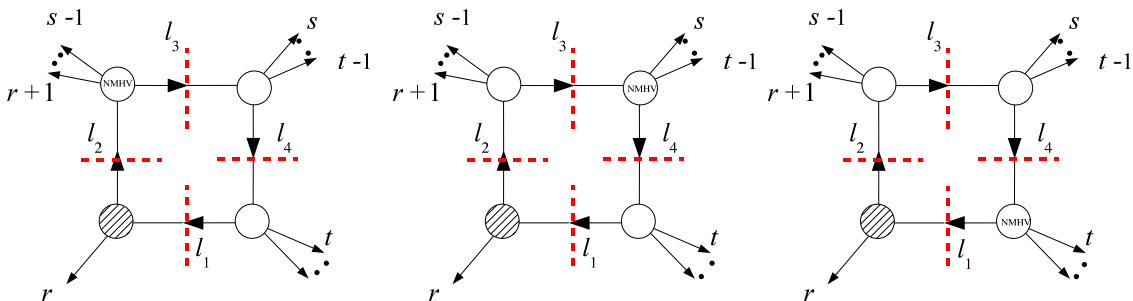

Figure 10: *Quadruple cut diagrams contributing to the three-mass supercoefficient in an N^2 MHV amplitude. Additional quadruple cut diagrams contributing to this supercoefficient are obtained as special cases of the four-mass quadruple cut diagram in Figure 9.*

We focus our attention for instance on the second diagram in Figure 10. This gives

$$\begin{aligned} \mathcal{C}_{3m}^{\mathcal{N}=8}(r, P, Q, R) |_2 &= \frac{1}{2} \sum_{S_{\pm}} \int \prod_{i=1}^4 d^8 \eta_i \mathcal{M}_3^{\overline{\text{MHV}}}(-l_1, r, l_2) \mathcal{M}^{\text{MHV}}(-l_2, P, l_3) \\ &\times \mathcal{M}^{\text{NMHV}}(-l_3, Q, l_4) \mathcal{M}^{\text{MHV}}(-l_4, R, l_1), \end{aligned} \quad (6.4)$$

where $P = \sum_{i=r+1}^{s-1} p_i$, $Q = \sum_{i=s}^{t-1} p_i$, $R = \sum_{i=t}^{r-1} p_i$. Because of the presence of a three-point anti-MHV amplitude, only one of the two cut solutions contributes to the cut diagram of Figure 1, therefore one can then drop the sum over solutions in (6.4). The explicit expressions (3.7), (4.11) and (4.12) may be inserted into this relation,

yielding

$$\begin{aligned}
\mathcal{C}_{3m}^{\mathcal{N}=8}(r, P, Q, R) |_2 &= \frac{1}{2} \int \prod_{i=1}^4 d^8 \eta_i \sum_{\mathcal{P}(P, Q, R)} [A_3^{\overline{\text{MHV}}}(-l_1, r, l_2)]^2 [A^{\text{MHV}}(-l_2, P, l_3)]^2 \\
&\times G^{\text{MHV}}(-l_2, P, l_3) [A^{\text{MHV}}(-l_3, Q, l_4)]^2 \left(\sum \sum R^2(-l_3, Q, l_4) G^{\text{NMHV}}(-l_3, Q, l_4) \right) \\
&\times [A^{\text{MHV}}(-l_4, R, l_1)]^2 G^{\text{MHV}}(-l_4, R, l_1) , \tag{6.5}
\end{aligned}$$

where we indicate the NMHV summation schematically for simplicity. Again, the key point, as noted in the discussion of NMHV amplitudes earlier, is that the fermionic variables corresponding to the loop momenta do not appear in the dressing factors or the R -functions. Hence one can perform these superspace integrations ignoring these functions – and this corresponds to performing the same steps as in the corresponding $\mathcal{N} = 4$ Yang-Mills case, with the difference that the result is squared. Thus we obtain

$$\begin{aligned}
\mathcal{C}_{3m}^{\mathcal{N}=8}(r, P, Q, R) |_2 &= 2 \sum_{\mathcal{P}(P, Q, R)} (\mathcal{C}_{3m}^{\mathcal{N}=4}(r, P, Q, R) |_2)^2 G^{\text{MHV}}(-l_2, P, l_3) \\
&\times \left(\sum \sum R^2(-l_3, Q, l_4) G^{\text{NMHV}}(-l_3, Q, l_4) \right) G^{\text{MHV}}(-l_4, R, l_1) , \tag{6.6}
\end{aligned}$$

where by $\mathcal{C}_{3m}^{\mathcal{N}=4}(r, P, Q, R) |_2$ we mean the result of the same quadruple cut diagram evaluated for $\mathcal{N} = 4$ SYM. The two-mass hard discussion goes along similar lines.

Finally, consider the two-mass easy case. There are four types of diagrams possible here. A first non-vanishing contribution is obtained as a special case of the four-mass quadruple cut (see Figure 9), when two opposite corners of the diagram are three-point MHV amplitudes.

A second possibility is a special case of the three-mass contributions considered earlier in Figure 10, where the MHV amplitude opposite to the anti-MHV three-point amplitude is also a three-point amplitude. This particular quadruple cut diagram will in general vanish as it would entail constraints on the external kinematics (this is not specific to the particular amplitudes considered here, but is a general feature of two-mass easy quadruple cuts where the two opposite three-point amplitudes cannot be one MHV and one anti-MHV).

The third contribution comes from diagrams with two anti-MHV amplitudes at opposite corners and two NMHV amplitudes at the other two corners, see Figure 11. This gives

$$\begin{aligned}
\mathcal{C}_{2me}^{\mathcal{N}=8}(1, P, s, Q) |_3 &= \frac{1}{2} \sum_{S_{\pm}} \int \prod_{i=1}^4 d^8 \eta_i \mathcal{M}_3^{\overline{\text{MHV}}}(-l_1, 1, l_2) \mathcal{M}^{\text{NMHV}}(-l_2, P, l_3) \\
&\times \mathcal{M}_3^{\overline{\text{MHV}}}(-l_3, s, l_4) \mathcal{M}^{\text{NMHV}}(-l_4, Q, l_1) , \tag{6.7}
\end{aligned}$$

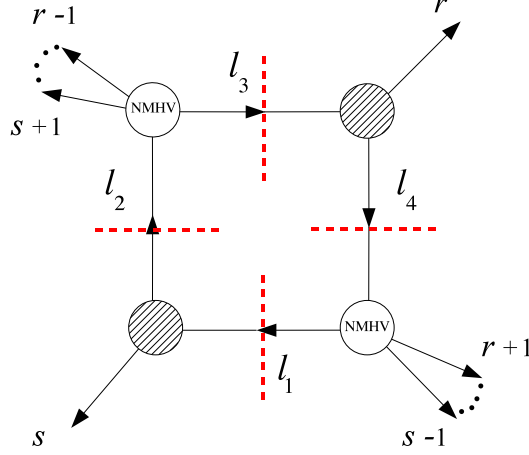

Figure 11: *Quadruple cut diagrams contributing to the two-mass easy coefficients of an N^2 MHV amplitude. The black amplitudes have the anti-MHV helicity configuration.*

where $P = \sum_{i=2}^{s-1} p_i$ and $Q = \sum_{i=s+1}^n p_i$. Now we insert the expressions for the anti-MHV amplitudes and the NMHV amplitudes, obtaining

$$\begin{aligned}
\mathcal{C}_{2\text{me}}^{\mathcal{N}=8}(1, P, s, Q) |_3 &= \frac{1}{2} \sum_{S_{\pm}} \sum_{\mathcal{P}(P, Q)} \int \prod_{i=1}^4 d^8 \eta_i \left(A_3^{\overline{\text{MHV}}}(-l_1, 1, l_2) A^{\text{MHV}}(-l_2, P, l_3) \right. \\
&\quad \times \left. A_3^{\overline{\text{MHV}}}(-l_3, s, l_4) A^{\text{MHV}}(-l_4, Q, l_1) \right)^2 \left(\sum \sum R^2 G^{\text{NMHV}} \right) (-l_2, P, l_3) \\
&\quad \times \left(\sum \sum R^2 G^{\text{NMHV}} \right) (-l_4, Q, l_1) , \tag{6.8}
\end{aligned}$$

using a shorthand notation as previously. Only one solution to the loop momenta conditions contributes, and one may perform the η integrals directly - this is the same calculation as for the MHV two-mass easy case, and thus we find the result

$$\begin{aligned}
\mathcal{C}_{2\text{me}}^{\mathcal{N}=8}(1, P, s, Q) |_3 &= \frac{1}{2} \sum_{\mathcal{P}(P, Q)} \left(\mathcal{C}_{2\text{me}}^{\mathcal{N}=4}(1, P, s, Q) \right)^2 \left(\sum \sum R^2 G^{\text{NMHV}} \right) (-l_2, P, l_3) \\
&\quad \times \left(\sum \sum R^2 G^{\text{NMHV}} \right) (-l_4, Q, l_1) , \tag{6.9}
\end{aligned}$$

where the solutions for the loop momenta need to be inserted into the terms containing the dressing functions R and G .

Lastly, there is the two-mass easy diagram represented in Figure 12, where a new ingredient is the presence of a tree-level N^2 MHV amplitude. This has been given

in [24], and we reproduce this here:

$$\begin{aligned} \mathcal{M}^{\mathcal{N}^2\text{MHV}}(1, \dots, n) &= \sum_{\mathcal{P}(2, \dots, n-1)} [A^{\text{MHV}}(1, \dots, n)]^2 \\ &\times \sum_{2 \leq a, b \leq n-1} R_{n;ab}^2 \left[\sum_{a \leq c, d < b} (R_{n;ab;cd}^{ba})^2 H_{n;ab;cd}^{(1)} + \sum_{b \leq c, d < n} (R_{n;cd}^{ab})^2 H_{n;ab;cd}^{(2)} \right]. \end{aligned} \quad (6.10)$$

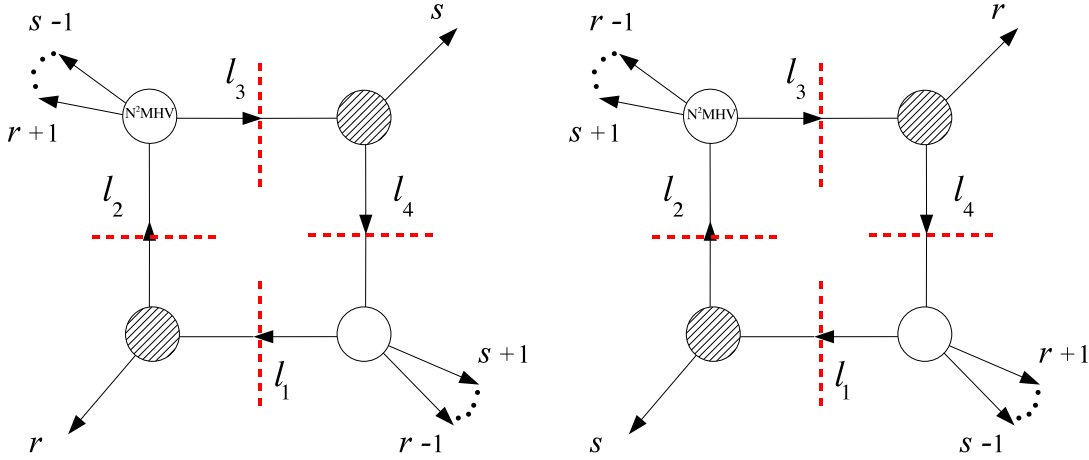

Figure 12: *Quadruple cut diagrams contributing to the two-mass easy coefficients of an $\mathcal{N}^2\text{MHV}$ amplitude.*

Explicit formulae for the H - and R -functions are given in [24]; for our purposes we will only need to know the fact that the H functions are independent of the superspace variables η , and the $R(1, \dots, n)$ functions do not depend on η_1 or η_n – the latter can be seen from the fact that these extremal values are never taken by the subscripts on the R 's, and the explicit form they take (see (2.14) of [24]). Let us write the above equation in the short-hand form

$$\mathcal{M}^{\mathcal{N}^2\text{MHV}}(1, \dots, n) = \sum_{\mathcal{P}(2, \dots, n-1)} [A^{\text{MHV}}(1, \dots, n)]^2 \sum \sum R^2 R^2 H(1, \dots, n) \quad (6.11)$$

Now we may write the quadruple cut for the two-mass easy diagrams as

$$\begin{aligned} \mathcal{C}_{2\text{me}}^{\mathcal{N}^2\text{MHV}}(r, P, s, Q) |_4 &= \frac{1}{2} \sum_{\mathcal{S}_{\pm}} \int \prod_{i=1}^4 d^8 \eta_i \mathcal{M}_3^{\overline{\text{MHV}}}(-l_1, r, l_2) \mathcal{M}^{\mathcal{N}^2\text{MHV}}(-l_2, P, l_3) \\ &\times \mathcal{M}_3^{\overline{\text{MHV}}}(-l_3, s, l_4) \mathcal{M}^{\text{MHV}}(-l_4, Q, l_1). \end{aligned} \quad (6.12)$$

As for the corresponding NMHV and MHV two-mass coefficients, only one of the two solutions to the cut condition contributes, given explicitly in (3.13). Taking this into account, we get

$$\begin{aligned}
\mathcal{C}_{2\text{me}}^{\mathcal{N}=8}(r, P, s, Q) |_4 &= \frac{1}{2} \int \prod_{i=1}^4 d^8 \eta_i \sum_{\mathcal{P}(P,Q)} [A^{\overline{\text{MHV}}}(-l_1, r, l_2)]^2 [A_3^{\text{MHV}}(-l_2, P, l_3)]^2 \\
&\times \sum \sum R^2 R^2 H(-l_2, P, l_3) [A^{\overline{\text{MHV}}}(-l_3, s, l_4)]^2 \\
&\times [A^{\text{MHV}}(-l_4, Q, l_1)]^2 G^{\text{MHV}}(-l_4, Q, l_1) .
\end{aligned} \tag{6.13}$$

We may perform the loop superspace integrals and the final answer is

$$\begin{aligned}
\mathcal{C}_{2\text{me}}^{\mathcal{N}=8}(r, P, s, Q) |_4 &= 2 \sum_{\mathcal{P}(P,Q)} (\mathcal{C}_{2\text{me}}^{\mathcal{N}=4}(r, P, s, Q) |_4)^2 G^{\text{MHV}}(-l_4, Q, l_1) \\
&\times \sum \sum R^2 R^2 H(-l_2, P, l_3) ,
\end{aligned} \tag{6.14}$$

where the loop momenta are replaced by the cut solution in (3.13). For the one-mass case, the only contribution comes from the special case of the last two-mass easy case discussed immediately above – that where Q contains only one external momentum.

Having given some details of how the calculation proceeds for the $\mathcal{N}^2\text{MHV}$ case, one can see how the general case will work. One can see from [24] that the generalised R -functions and dressing factors which arise in any quadruple cut do not depend upon the η variables corresponding to the loop momenta; hence one may perform the superspace integrals with these functions as spectators. This calculation is however precisely the same as the corresponding $\mathcal{N} = 4$ Yang-Mills case, except that the coefficient is squared in the result. The outcome is that the $\mathcal{N} = 8$ supergravity coefficient is given by a sum of the squares of the result of the corresponding $\mathcal{N} = 4$ Yang-Mills calculation, factored into sums and products of R -functions and dressing factors. There is also in general a sum over solutions of the cut equation, which need to be inserted into these expressions. Thus we see how this approach yields $\mathcal{N} = 8$ supergravity coefficients in terms of squares of the results of $\mathcal{N} = 4$ Yang-Mills calculations.

7 Conclusions

We have shown here in a number of cases how generalised unitarity can be used in order to generate new expressions for one-loop supercoefficients in $\mathcal{N} = 8$ supergravity, and indicated how this applies in general. In particular, using recent results for tree amplitudes [21, 24], the one-loop supercoefficients take an intriguing form involving sums of squares of $\mathcal{N} = 4$ Yang-Mills one-loop expressions, times dressing

factors. It seems likely that this structure will apply to all one-loop supercoefficients in $\mathcal{N} = 8$ supergravity. It is certainly of interest to take this further, proving more general results in detail, deriving algorithms which produce the loop dressing factors, and simplifying the expressions obtained when the solutions to the quadruple cut conditions for the loop momenta are inserted. For the MHV case, it was easy to eliminate the loop momenta from the expressions we derived, and thus find a direct correspondence with known results. It may be that a similar outcome can be attained for non-MHV cases. The loop momenta solutions are known explicitly, however the dressing factors entering non-MHV amplitudes are more complex.

It is intriguing that both tree-level superamplitudes and one-loop coefficients can be written in terms of squares of dual superconformal invariant quantities times bosonic dressing factors. It would be interesting to understand what possible deeper reasons may underly these regularities. In this context, we note that in [30] it was shown that the dual superconformal invariant R -functions appearing in the NMHV amplitudes in $\mathcal{N} = 4$ SYM have a coplanar twistor-space localisation. It would be interesting if one could relate the simplicity of the tree-level and one-loop results in $\mathcal{N} = 8$ supergravity to simple twistor-space localisation properties. Interesting new ideas have been put forward recently [44–46] which in particular make a connection between on-shell recursion relations and twistor space [44–48].

Underlying some of the work here are supersymmetric recursion relations [6, 25]. Interestingly, there are additional recursion relations for $\mathcal{N} = 8$ supergravity amplitudes, arising from the fact that the tree amplitudes have a $1/z^2$ fall-off at large z [6, 23]. At present, the conditions imposed by this constraint on one-loop amplitudes have not been much investigated. One might study the large- z behaviour of the new expressions presented here for the supercoefficients and explore possible recursion relations for these, along the lines of [49].

Acknowledgements

It is a pleasure to thank Andi Brandhuber, Paul Heslop, Mark Spradlin, Pierre Vanhove, Cristian Vergu and Anastasia Volovich for interesting discussions. GT would like to thank the Theory Group at Brown University for their warm hospitality and the opportunity to present the results of this paper. This work was supported by the STFC under a Rolling Grant ST/G000565/1. GT is supported by an EPSRC Advanced Research Fellowship EP/C544242/1 and by an EPSRC Standard Research Grant EP/C544250/1.

References

- [1] J. Bedford, A. Brandhuber, B. Spence and G. Travaglini, *A recursion relation for gravity amplitudes*, Nucl. Phys. B **721** (2005) 98, [hep-th/0502146](#).
- [2] F. Cachazo and P. Svrcek, *Tree level recursion relations in general relativity*, [hep-th/0502160](#).
- [3] R. Britto, F. Cachazo, B. Feng and E. Witten, *Direct proof of tree-level recursion relation in Yang-Mills theory*, Phys. Rev. Lett. **94** (2005) 181602, [hep-th/0501052](#).
- [4] P. Benincasa, C. Boucher-Veronneau and F. Cachazo, *Taming tree amplitudes in general relativity*, JHEP **0711** (2007) 057, [hep-th/0702032](#).
- [5] N. Arkani-Hamed and J. Kaplan, *On Tree Amplitudes in Gauge Theory and Gravity*, JHEP **0804** (2008) 076, [0801.2385 \[hep-th\]](#).
- [6] N. Arkani-Hamed, F. Cachazo and J. Kaplan, *What is the Simplest Quantum Field Theory?*, [0808.1446 \[hep-th\]](#).
- [7] Z. Bern, L. J. Dixon, M. Perelstein and J. S. Rozowsky, *Multi-leg one-loop gravity amplitudes from gauge theory*, Nucl. Phys. B **546** (1999) 423, [hep-th/9811140](#).
- [8] Z. Bern, N. E. J. Bjerrum-Bohr and D. C. Dunbar, *Inherited twistor-space structure of gravity loop amplitudes*, JHEP **0505** (2005) 056, [hep-th/0501137](#).
- [9] N. E. J. Bjerrum-Bohr, D. C. Dunbar and H. Ita, *Six-point one-loop $N = 8$ supergravity NMHV amplitudes and their IR behaviour*, Phys. Lett. B **621** (2005) 183, [hep-th/0503102](#).
- [10] N. E. J. Bjerrum-Bohr, D. C. Dunbar, H. Ita, W. B. Perkins and K. Risager, *The no-triangle hypothesis for $N = 8$ supergravity*, JHEP **0612** (2006) 072, [hep-th/0610043](#).
- [11] N. E. J. Bjerrum-Bohr and P. Vanhove, *Explicit Cancellation of Triangles in One-loop Gravity Amplitudes*, JHEP **0804** (2008) 065, [0802.0868 \[hep-th\]](#).
- [12] Z. Bern, J. J. Carrasco, D. Forde, H. Ita and H. Johansson, *Unexpected Cancellations in Gravity Theories*, Phys. Rev. D **77** (2008) 025010, [0707.1035 \[hep-th\]](#).
- [13] S. Badger, N. E. J. Bjerrum-Bohr and P. Vanhove, *Simplicity in the Structure of QED and Gravity Amplitudes*, JHEP **0902** (2009) 038, [0811.3405 \[hep-th\]](#).
- [14] Z. Bern, L. J. Dixon and R. Roiban, *Is $N = 8$ supergravity ultraviolet finite?*, Phys. Lett. B **644** (2007) 265, [hep-th/0611086](#).

- [15] Z. Bern, J. J. Carrasco, L. J. Dixon, H. Johansson, D. A. Kosower and R. Roiban, *Three-Loop Superfiniteness of $N=8$ Supergravity*, Phys. Rev. Lett. **98** (2007) 161303, [hep-th/0702112](#).
- [16] Z. Bern, J. J. Carrasco, L. J. Dixon, H. Johansson and R. Roiban, *The Ultraviolet Behavior of $N=8$ Supergravity at Four Loops*, 0905.2326 [[hep-th](#)].
- [17] G. Chalmers, *On the finiteness of $N = 8$ quantum supergravity*, [hep-th/0008162](#).
- [18] M. B. Green, J. G. Russo and P. Vanhove, *Non-renormalisation conditions in type II string theory and maximal supergravity*, JHEP **0702** (2007) 099, [hep-th/0610299](#).
- [19] M. B. Green, J. G. Russo and P. Vanhove, *Ultraviolet properties of maximal supergravity*, Phys. Rev. Lett. **98** (2007) 131602 [hep-th/0611273](#).
- [20] N. Berkovits, *New higher-derivative R^{*4} theorems*, Phys. Rev. Lett. **98** (2007) 211601, [hep-th/0609006](#).
- [21] H. Elvang and D. Z. Freedman, *Note on graviton MHV amplitudes*, JHEP **0805** (2008) 096, 0710.1270 [[hep-th](#)].
- [22] F. A. Berends, W. T. Giele and H. Kuijf, *On relations between multi - gluon and multigraviton scattering*, Phys. Lett. B **211** (1988) 91.
- [23] M. Spradlin, A. Volovich and C. Wen, *Three Applications of a Bonus Relation for Gravity Amplitudes*, Phys. Lett. B **674** (2009) 69, 0812.4767 [[hep-th](#)].
- [24] J. M. Drummond, M. Spradlin, A. Volovich and C. Wen, *Tree-Level Amplitudes in $N=8$ Supergravity*, 0901.2363 [[hep-th](#)].
- [25] A. Brandhuber, P. Heslop and G. Travaglini, *A note on dual superconformal symmetry of the $N=4$ super Yang-Mills S -matrix*, Phys. Rev. D **78** (2008) 125005, 0807.4097 [[hep-th](#)].
- [26] R. Britto, F. Cachazo and B. Feng, *New recursion relations for tree amplitudes of gluons*, Nucl. Phys. B **715** (2005) 499, [hep-th/0412308](#).
- [27] J. M. Drummond and J. M. Henn, *All tree-level amplitudes in $N=4$ SYM*, JHEP **0904** (2009) 018, 0808.2475 [[hep-th](#)].
- [28] V. P. Nair, *A current algebra for some gauge theory amplitudes*, Phys. Lett. B **214** (1988) 215.
- [29] J. M. Drummond, J. Henn, G. P. Korchemsky and E. Sokatchev, *Generalized unitarity for $N=4$ superamplitudes*, 0808.0491 [[hep-th](#)].

- [30] J. M. Drummond, J. Henn, G. P. Korchemsky and E. Sokatchev, *Dual superconformal symmetry of scattering amplitudes in $N=4$ super-Yang-Mills theory*, 0807.1095 [hep-th].
- [31] R. Britto, F. Cachazo and B. Feng, *Generalized unitarity and one-loop amplitudes in $N = 4$ super-Yang-Mills*, Nucl. Phys. B **725**, 275 (2005), hep-th/0412103.
- [32] G. Georgiou and V. V. Khoze, *Tree amplitudes in gauge theory as scalar MHV diagrams*, JHEP **0405** (2004) 070, hep-th/0404072.
- [33] A. Brandhuber, B. Spence and G. Travaglini, *One-loop gauge theory amplitudes in $N = 4$ super Yang-Mills from MHV vertices*, Nucl. Phys. B **706** (2005) 150, hep-th/0407214.
- [34] M. Bianchi, H. Elvang and D. Z. Freedman, *Generating Tree Amplitudes in $N=4$ SYM and $N = 8$ SG*, JHEP **0809** (2008) 063, 0805.0757 [hep-th]
- [35] H. Elvang, D. Z. Freedman and M. Kiermaier, *Recursion Relations, Generating Functions, and Unitarity Sums in $N=4$ SYM Theory*, JHEP **0904** (2009) 009, 0808.1720 [hep-th].
- [36] H. Elvang, D. Z. Freedman and M. Kiermaier, *Proof of the MHV vertex expansion for all tree amplitudes in $N=4$ SYM theory*, 0811.3624 [hep-th].
- [37] Z. Bern, J. J. M. Carrasco, H. Ita, H. Johansson and R. Roiban, *On the Structure of Supersymmetric Sums in Multi-Loop Unitarity Cuts*, 0903.5348 [hep-th].
- [38] H. Kawai, D. C. Lewellen and S. H. H. Tye, *A Relation Between Tree Amplitudes Of Closed And Open Strings*, Nucl. Phys. B **269** (1986) 1.
- [39] A. Hall, *Supersymmetric Yang-Mills and Supergravity Amplitudes at One Loop*, 0906.0204.
- [40] Z. Bern, L. J. Dixon, D. C. Dunbar and D. A. Kosower, *One Loop N Point Gauge Theory Amplitudes, Unitarity And Collinear Limits*, Nucl. Phys. B **425** (1994) 217, hep-ph/9403226.
- [41] Z. Bern, L. J. Dixon and D. A. Kosower, *Dimensionally regulated pentagon integrals*, Nucl. Phys. B **412** (1994) 751, hep-ph/9306240.
- [42] C. F. Berger *et al.*, *An Automated Implementation of On-Shell Methods for One-Loop Amplitudes*, Phys. Rev. D **78** (2008) 036003, 0803.4180 [hep-ph].
- [43] K. Risager, *Unitarity and On-Shell Recursion Methods for Scattering Amplitudes*, 0804.3310 [hep-th].
- [44] L. Mason and D. Skinner, *Scattering Amplitudes and BCFW Recursion in Twistor Space*, 0903.2083 [hep-th].

- [45] N. Arkani-Hamed, F. Cachazo, C. Cheung and J. Kaplan, *The S-Matrix in Twistor Space*, 0903.2110 [[hep-th](#)].
- [46] A. Hodges, *Eliminating spurious poles from gauge-theoretic amplitudes*, 0905.1473 [[hep-th](#)].
- [47] A. P. Hodges, *Twistor diagrams for all tree amplitudes in gauge theory: A helicity-independent formalism*, [hep-th/0512336](#).
- [48] B. Chen and J. B. Wu, *Tree-level Split Helicity Amplitudes in Ambitwistor Space*, 0905.0522 [[hep-th](#)].
- [49] Z. Bern, N. E. J. Bjerrum-Bohr, D. C. Dunbar and H. Ita, *Recursive calculation of one-loop QCD integral coefficients*, *JHEP* **0511** (2005) 027, [hep-ph/0507019](#).