

TECHNOLOGY, TECHNIQUES, AND TECHNICIANS AT THE NATIONAL INSTITUTE FOR MEDICAL RESEARCH (NIMR) *c.1960–c.2000*

The transcript of a Witness Seminar held by the History
of Modern Biomedicine Research Group, Queen Mary
University of London, on 17 June 2014

Edited by C Overy and E M Tansey

©The Trustee of the Wellcome Trust, London, 2016

First published by Queen Mary University of London, 2016

The History of Modern Biomedicine Research Group is funded by the Wellcome Trust, which is a registered charity, no. 210183.

ISBN 978 1 91019 5161

All volumes are freely available online at www.histmodbiomed.org

Please cite as: Overy C, Tansey E M. (eds) (2016) *Technology, Techniques, and Technicians at the National Institute for Medical Research (NIMR) c.1960–c.2000*. Wellcome Witnesses to Contemporary Medicine, vol. 59. London: Queen Mary University of London.

CONTENTS

| | |
|---|------|
| What is a Witness Seminar? | v |
| Acknowledgements E M Tansey and C Overy | vii |
| Illustrations and credits | ix |
| Abbreviations | xv |
| Introduction Jim Smith | xvii |
| Transcript Edited by C Overy and E M Tansey | 1 |
| Appendix 1 Floor plans of the NIMR at Holly Hill | 125 |
| Appendix 2 The fraction collector | 127 |
| Appendix 3 A history of the chemistry laboratory: Form and function Peter J T Morris | 129 |
| Appendix 4 Computers at the NIMR Steven White | 145 |
| Appendix 5 The planimeter Anthony S Travis | 149 |

Appendix 6

The first decade at the NIMR, Mill Hill: The instruments that revolutionized analytical chemistry

Anthony S Travis 151

Appendix 7

Apparatus used to prepare cell walls

Ian Mathison 171

Appendix 8

References by Sutherland *et al.* for pump and countercurrent chromatography research at the NIMR, showing NIMR Scientists and NIMR Research Officers and Technicians

Ian Sutherland 173

Biographical notes 177

References 187

Index 197

Witness Seminars: Meetings and publications 209

WHAT IS A WITNESS SEMINAR?

The Witness Seminar is a specialized form of oral history, where several individuals associated with a particular set of circumstances or events are invited to meet together to discuss, debate, and agree or disagree about their memories. The meeting is recorded, transcribed, and edited for publication.

This format was first devised and used by the Wellcome Trust's History of Twentieth Century Medicine Group in 1993 to address issues associated with the discovery of monoclonal antibodies. We developed this approach after holding a conventional seminar, given by a medical historian, on the discovery of interferon. Many members of the invited audience were scientists or others involved in that work, and the detailed and revealing discussion session afterwards alerted us to the importance of recording 'communal' eyewitness testimonies. We learned that the Institute for Contemporary British History held meetings to examine modern political, diplomatic, and economic history, which they called Witness Seminars, and this seemed a suitable title for us to use also.

The unexpected success of our first Witness Seminar, as assessed by the willingness of the participants to attend, speak frankly, agree and disagree, and also by many requests for its transcript, encouraged us to develop the Witness Seminar model into a full programme, and since then more than 65 meetings have been held and published on a wide array of biomedical topics.¹ These seminars have proved an ideal way to bring together clinicians, scientists, and others interested in contemporary medical history to share their memories. We are not seeking a consensus, but are providing the opportunity to hear an array of voices, many little known, of individuals who were 'there at the time' and thus able to question, ratify, or disagree with others' accounts – a form of open peer-review. The material records of the meeting also create archival sources for present and future use.

The History of Twentieth Century Medicine Group became a part of the Wellcome Trust's Centre for the History of Medicine at UCL in October 2000 and remained so until September 2010. It has been part of the School of History, Queen Mary University of London, since October 2010, as the History of Modern Biomedicine Research Group, which the Wellcome Trust

¹ See pages 209–15 for a full list of Witness Seminars held, details of the published volumes, and other related publications.

funds principally under a Strategic Award entitled ‘The Makers of Modern Biomedicine’. The Witness Seminar format continues to be a major part of that programme, although now the subjects are largely focused on areas of strategic importance to the Wellcome Trust, including the neurosciences, clinical genetics, and medical technology.²

Once an appropriate topic has been agreed, usually after discussion with a specialist adviser, suitable participants are identified and invited. As the organization of the Seminar progresses and the participants’ list is compiled, a flexible outline plan for the meeting is devised, with assistance from the meeting’s designated chairman/moderator. Each participant is sent an attendance list and a copy of this programme before the meeting. Seminars last for about four hours; occasionally full-day meetings have been held. After each meeting the raw transcript is sent to every participant, each of whom is asked to check his or her own contribution and to provide brief biographical details for an appendix. The editors incorporate participants’ minor corrections and turn the transcript into readable text, with footnotes, appendices, and a bibliography. Extensive research and liaison with the participants is conducted to produce the final script, which is then sent to every contributor for approval and to assign copyright to the Wellcome Trust. Copies of the original, and edited, transcripts and additional correspondence generated by the editorial process are all deposited with the records of each meeting in the Wellcome Library, London (archival reference GC/253) and are available for study.

For all our volumes, we hope that, even if the precise details of the more technical sections are not clear to the non-specialist, the sense and significance of the events will be understandable to all readers. Our aim is that the volumes inform those with a general interest in the history of modern medicine and medical science; provide historians with new insights, fresh material for study, and further themes for research; and emphasize to the participants that their own working lives are of proper and necessary concern to historians.

² See our group’s website at www.histmodbiomed.org.

ACKNOWLEDGEMENTS

The subject of laboratory technicians has been a long-standing interest of one of us (TT). In various discussions with Jon Marsh, Andrew Pinder, John Sawkins, and Tony Travis, the idea arose of organizing a Witness Seminar on the topic, within the defined remit of the National Institute for Medical Research (NIMR), which was about to close. We are very grateful to them for their help in planning this full-day meeting. We thank Dr Jim Smith for writing the introduction to the volume, which highlights his own long personal and professional association with the NIMR, and our gratitude also goes to several of the participants for providing the additional information in the appendices and for many of the images used to illustrate the volume. We also thank the Medical Research Council and the Institution of Mechanical Engineers for permission to reproduce a number of the figures, and the Wellcome Library, London, for permission to use photographs taken at the meeting, and historical images, which are reproduced under the terms of the Creative Commons Licence (<http://creativecommons.org/licenses/by/4.0/>). We are particularly grateful to Tony Travis and Peter Morris for providing short lectures during the meeting, which are reproduced in the appendices.

As with all our meetings, we depend a great deal on Wellcome Trust staff to ensure their smooth running: Audiovisual, Catering, Reception, Security, and Wellcome Images. We are also grateful to Mr Akio Morishima for the design and production of this volume; the indexer Ms Cath Topliff; Mrs Sarah Beanland and Ms Fiona Plowman for proofreading; Mrs Debra Gee for transcribing the seminar; and Mr Adam Wilkinson who assisted in the organization and running of the meeting. Finally, we thank the Wellcome Trust for supporting this programme.

Tilli Tansey

Caroline Overy

School of History, Queen Mary University of London

ILLUSTRATIONS AND CREDITS*

| | | |
|-----------|---|-----|
| Figure A | Dr Jim Smith, reproduced with his permission | xix |
| Figure 1 | Dr Peter Morris, Dr Anthony Travis, and Professor Tilli Tansey | 3 |
| Figure 2 | Professor Heinz Wolff | 5 |
| Figure 3 | National Institute for Medical Research: Hampstead. Credit: Wellcome Library, London | 6 |
| Figure 4 | Mrs Rosemary de Rossi | 7 |
| Figure 5 | Mr Ian Mathison | 10 |
| Figure 6 | Mr Jonathan Marsh | 11 |
| Figure 7 | Cover of a season's greetings card showing the NIMR at Mill Hill. Image supplied by Dr Anthony Travis from the Regina Schonfield Collection, Edelstein Center, The Hebrew University of Jerusalem, used with the permission of the Medical Research Council | 14 |
| Figure 8 | Mrs Hilary Morgan | 16 |
| Figure 9 | Dr Peter Morris | 17 |
| Figure 10 | Brunel College of Advanced Technology in 1963 and Mr Jonathan Marsh and a colleague studying for Higher National Certificate in Applied Biology at Brunel in 1964. Photographs supplied by and reproduced with permission of Mr Jonathan Marsh | 18 |
| Figure 11 | The fraction collector. Photograph supplied by and reproduced with permission of Mr Ian Mathison | 23 |
| Figure 12 | The NIMR Safety Handbook, <i>c.</i> 1975/76. Document supplied by Mr Ian Mathison and used with the permission of the Medical Research Council | 29 |

* Unless otherwise stated, all photographs were taken by Thomas Farnetti, Wellcome Trust, and reproduced courtesy of the Wellcome Library, London.

| | | |
|-----------|--|----|
| Figure 13 | Les Hills, Senior Technician in the Chemotherapy Division in the 1960s. Photograph supplied by and reproduced with permission of Mr Jonathan Marsh | 33 |
| Figure 14 | Toilet paper from the NIMR (1950s) | 35 |
| Figure 15 | Dr Peter Morris speaking on the history of the chemical laboratory | 36 |
| Figure 16 | Mr Peter Turner | 37 |
| Figure 17 | Professor Ian Sutherland | 40 |
| Figure 18 | Dr Andrew Pinder | 47 |
| Figure 19 | Demonstration of electrophoresis apparatus at NIMR, 25 October 1974. Photograph supplied by and reproduced with permission of Mr Ian Mathison | 49 |
| Figure 20 | A galvanometer balance in a small environmentally controlled chamber used to weigh small droplets infused from test infusers. Photographs supplied by Professor Ian Sutherland and reproduced with permission of the Institution of Mechanical Engineers | 52 |
| Figure 21 | The old lead screw drive and the new spline drive. Diagram supplied by Professor Ian Sutherland and reproduced with permission of the Institution of Mechanical Engineers | 53 |
| Figure 22 | Mr Geof Chambers | 54 |
| Figure 23 | The Nordisk Infuser | 56 |
| Figure 24 | The Mill Hill Infuser breadboard. Photo supplied by and reproduced with permission of Mr John Sawkins | 57 |
| Figure 25 | Mr Steven White | 58 |
| Figure 26 | Mr John Sawkins | 61 |

| | | |
|-----------|---|-----|
| Figure 27 | Peristaltic pumps. Photograph supplied by and reproduced with permission of Mr Ian Mathison | 63 |
| Figure 28 | Dr Anthony Travis | 64 |
| Figure 29 | Mr Roger Hooper | 66 |
| Figure 30 | Lecture by Dr Anthony Travis | 67 |
| Figure 31 | Mr Russell Higgins | 81 |
| Figure 32 | Keeyok, the NIMROD Social Club boat in the boatyard on the River Hamble. Photograph supplied by and reproduced with permission of Mr Jonathan Marsh | 82 |
| Figure 33 | <i>NIMROD Magazine</i> (1967). Document supplied by Mr Ian Mathison and used with the permission of the Medical Research Council | 85 |
| Figure 34 | Mr John Sawkins in the workshop <i>c.</i> 2009. Photograph supplied by and reproduced with permission of Mr John Sawkins | 89 |
| Figure 35 | Mr Ian Mathison and Dr Howard Rogers in the Division of Microbiology <i>c.</i> 1969. Photograph supplied by and reproduced with permission of Mr Ian Mathison | 97 |
| Figure 36 | Programme of the Institute's 25th Anniversary Open Evening. Document supplied by Mr Ian Mathison and used with the permission of the Medical Research Council | 121 |
| Figure 37 | Mr John Satchell and Mr Jonathan Marsh with the tea-making machine made to demonstrate electronics measurement and control during an open day at the NIMR. Photograph supplied by and reproduced with permission of Mr Jonathan Marsh | 122 |

| | | |
|------------|---|-------|
| Table 1 | Suggested Themes for the Witness Seminar 'Technology, techniques, and technicians at the NIMR c.1960 to c.2000' | 4 |
| Table 2 | The Directors of the NIMR | 47 |
| Appendix 1 | Floorplans of the NIMR at Hampstead, c. late 1930s, drawn by Mr Leonard Ward for Professor Tilli Tansey | 125–6 |
| Appendix 3 | | |
| Figure 1 | Engraving of an alchemical laboratory from <i>Philosophical Commerce of Arts</i> , William Lewis, 1765. Credit: Wellcome Library, London | 129 |
| Figure 2 | An alchemical laboratory from Ercker L. (1683) <i>The Laws of Art and Nature in Knowing, Judging, Assaying, Fining, Refining and Inlarging the Bodies of Confin'd Metals</i> . London: Thomas Dawks. Credit: Wellcome Library, London | 130 |
| Figure 3 | Chemical Laboratory of the Eidgenossische Technische Hochschule, Zurich, 1930. Credit: Wellcome Library, London | 130 |
| Figure 4 | Lavoisier experimenting on the respiration of a man at rest, with his wife taking notes. Credit: Wellcome Library, London | 132 |
| Figure 5 | Liebig's Laboratory at Giessen. Credit: Wellcome Library, London | 132 |
| Figure 6 | Steam distillation at Apothecaries' Hall. Credit: Wellcome Library, London | 134 |
| Figure 7 | Wellcome Chemical Research Laboratory, 6 King Street, 1899. Credit: Wellcome Library, London | 135 |

| | | |
|-----------------------|--|-----|
| Appendix 4 | DEC 2040 mainframe computer. Photograph supplied by Mr Steven White from the 1979/1980 NIMR annual report used with the permission of the Medical Research Council | 146 |
| Appendix 6 | | |
| Figure 1 | Archer Martin and Anthony James at Mill Hill in the 1950s. Photograph supplied by Dr Anthony Travis and used with the permission of the Medical Research Council | 162 |
| Figure 2 | James E Lovelock, <i>c.</i> 1960. Photograph supplied by Dr Anthony Travis (held in the Regina Schonfield Collection, Edelstein Center, Hebrew University of Jerusalem) and used with the permission of the Medical Research Council | 165 |
| Figure 3 | Diagram of Lovelock's electron capture detector. Figure supplied by and reproduced with permission of Dr Anthony Travis and the Edelstein Center, Hebrew University of Jerusalem | 167 |

ABBREVIATIONS

| | |
|--------------|--|
| AScW | Association of Scientific Workers |
| ASTMS | Association of Scientific, Technical and Managerial Staffs |
| BBSRC | Biotechnology and Biological Sciences Research Council |
| DEC | Digital Equipment Corporation |
| ECD | Electron capture detector |
| GC | Gas chromatography |
| GHRH | Growth hormone releasing hormone |
| JNCC | Joint Negotiating and Consultative Committee |
| LHRH | Luteinizing hormone releasing hormone |
| MBI | Medical and Biological Instrumentation |
| MOD | Ministry of Defence |
| MRC | Medical Research Council |
| MSF | Manufacturing, Science and Finance |
| NASA | National Aeronautics and Space Administration |
| NIH | National Institutes of Health |
| NIMR | National Institute for Medical Research |
| NMR | Nuclear magnetic resonance |
| NRDC | National Research Development Corporation |
| PRU | Pneumoconiosis Research Unit |
| RO | Research Officer |
| SAMI | Socially acceptable monitoring instruments |
| TO | Technical Officer |
| WHO | World Health Organization |

INTRODUCTION

As the last-ever Director of the MRC National Institute for Medical Research, my job was to keep the Institute doing great research, to get it through its quinquennial review, and, perhaps most important of all, to prepare for the NIMR's move to the Francis Crick Institute. The story of the move to the Crick might well be a subject of a Witness Seminar in the future. But throughout my time as Director, in spite of the various distractions, I could not help but look back at the history of NIMR – especially during 2014, the year that saw the Institute's centenary. As readers of this Witness Seminar will discover, to mark the centenary we commissioned a history of NIMR entitled *A Century of Science for Health*.¹ I am really grateful to its main author, Julie Clayton, and to Frank Norman and Jonathan Stoye from Mill Hill, for all their work in producing a book that provides an unapologetically NIMR-centric view of the Institute's life and science. In addition to this, Taslima Khan (a former PhD student) produced a terrific film about Mill Hill called *The National Institute for Medical Research: The place, the people, the science*.² This, perhaps more than the book, focused on the day-to-day life of NIMR, as Tas says: 'when "Health and Safety" was non-existent and scientists smoked in the lab; to the requirements of wartime and the changing needs of a Nation. From the Antarctic to antibiotics; flamethrowers to flu; hygiene to Hox genes; Macrocydon to mesoderm; T-cells to *Toxoplasma gondii*, NIMR did it all.'

Of course, the present volume stands on its own as a record of life at the Institute from the perspective of the technical staff. However, it complements both the NIMR history and the film. In particular, it introduces some of the characters in more detail, provides context, and gives remarkable insights into what makes an institute work. There are also some stories that might one day be included in a second edition of the history or the 'uncut' version of the film. I think particularly of the incident involving three Rhesus monkeys, the Prime Minister, Sir Henry Dale, and Hampstead Heath. Times have indeed changed, and I can only say how pleased I am that this didn't happen under my Directorship!³

One of the pleasures of reading this Witness Seminar is in hearing the voices of former colleagues. Although I became Director of NIMR at the beginning

¹ Clayton and NIMR staff (2014).

² A trailer to the film is available online at <https://vimeo.com/138064056> (accessed 27 April 2016), and the first part of the film can be seen at www.histmodbiomed.org/article/mrc-national-institute-medical-research-place-people-science (accessed 26 April 2016).

³ See page 23–4.

of 2009, I had previously worked at Mill Hill from 1984 to 2000 (I spent the intervening nine years at the Gurdon Institute in Cambridge). My knowledge of Mill Hill therefore goes back almost a third of a century, and indeed I worked with some of the dramatis personae in this volume. Many of them I have seen quite recently at various NIMR Retirees' Christmas lunches, including Rosemary de Rossi, Jon Marsh, Ian Mathison, John Sawkins, and Pete Turner. Ian was my Head Technician when I came to Mill Hill as a tenure-track group leader in 1984, and when it came to getting things done, or finding the right widget, he was just the man. It was said of him (I won't say by whom) that he had a compartment in one of those multi-drawer plastic storage cabinets labelled 'Pieces of string too short to be of any use'. I have since Googled this expression, and it seems to be quite a common joke, so I'm sure it's not true, Ian. Or is it?

The first reaction to the conversations in this volume must be how things have changed since the 1960s and 1970s. The participants highlight many examples, a large number of which concern Health and Safety. After my own experiences as a technician at the Tin Research Institute in 1973, I shouldn't be surprised by the participants' references to the liberal use of chromic acid, the mouth pipetting, the smoking, the splashing around of solvents and radioactivity, the cooking of sausages in the fume cupboard, and the heating of Christmas puddings in the autoclaves.⁴ But I must admit that I really was surprised, and this modern-day Director could barely suppress a shudder, at some of the antics described. We may have been a little cavalier with the chromic acid at the Tin Research Institute, but we certainly didn't cook sausages in the fume cupboards. And I don't think the institutional hierarchy or the 'Late Book' would go down very well today! Together with tales of the Institute's social club, NIMROD, these wonderful stories show the Institute at its occasionally quirky best, and they emphasize how that quirkiness led to some fantastic science. One can understand Robin Lovell-Badge's words near the end of the film: 'Yes, it does look a bit like a mental institution, which of course is why it was used in the Batman movie as that. But it's...it's not a mental institute, it's not. We're not insane. It's...it's just a great place.'

But more than all this, I was impressed by the Institute's fantastic achievements, often mentioned *en passant* by those at the Witness Seminar and many of which pass unremarked outside NIMR. Some of these are described in detail in *A Century of Science for Health*, but it is worth emphasizing here their breadth and their significance. There was Griff Pugh's work on human physiology, which made possible the ascent of Everest (we were privileged to hear Pugh's daughter,

⁴ See, for example, page 119.

Harriet Tuckey, speak at Mill Hill a few years ago about her father's work).⁵ There was the development of a drop-counting fraction collector that was eventually manufactured and sold by two people in electronics through a company called Medical and Biological Instrumentation (MBI).⁶ There was, of course, gas chromatography,⁷ and there was the invention that would have saved me much time when I did my PhD, which was the planimeter to measure the area under the curve on a graph. The alternative, and these days it's hard to believe, was to cut out the area and weigh the paper, and I did an awful lot of this.⁸

All this is in addition to the Institute's better-known achievements, which one can read about elsewhere. Reading about them all, it is clear that many innovations came through the Institute's commitment to basic research, taking advantage of the academic freedom afforded by core funding, and of Mill Hill's multidisciplinary environment. Jon Marsh mentioned twice that he hoped the freedom to innovate would not be lost when NIMR moves to the Crick and I think I can reassure him that it won't be.⁹ The Crick's first strategic priority is *Discovery Without Boundaries*, with the intention to 'develop a distinctive approach to biomedical research that fosters excellence, breaks down barriers between disciplines, works across institutions and integrates knowledge gained from studies at different levels: molecular, cellular, organ, whole organism and population.'¹⁰ I think the Crick should look carefully at what NIMR has achieved over its 100-year history and which is summarized with such immediacy, and so entertainingly, in this volume.

Dr Jim Smith

Director, MRC National Institute
for Medical Research, 2009–2015



Figure A

⁵ See page 12.

⁶ See pages 22–23.

⁷ See Appendix 6.

⁸ See pages 64–5 and Appendix 5.

⁹ See pages 46 and 68.

¹⁰ *Discovery Without Boundaries. Strategy 2013*, page 13, online at www.crick.ac.uk/media/131115/tfc_full_document_for_web_single_pages.pdf (accessed 17 May 2016).

TECHNOLOGY, TECHNIQUES, AND TECHNICIANS AT THE NATIONAL INSTITUTE FOR MEDICAL RESEARCH (NIMR) c.1960–c.2000

The transcript of a Witness Seminar held by the History
of Modern Biomedicine Research Group, Queen Mary
University of London, on 17 June 2014

Edited by C Overy and E M Tansey

TECHNOLOGY, TECHNIQUES, AND TECHNICIANS AT THE NATIONAL INSTITUTE FOR MEDICAL RESEARCH (NIMR) c.1960–c.2000

Participants*

Mr Geof Chambers

Mrs Rosemary de Rossi

Mr Russell Higgins

Mr Roger Hooper

Mr Jonathan Marsh

Mr Ian Mathison

Mrs Hilary Morgan

Dr Peter Morris

Dr Andrew Pinder

Mr John Sawkins

Professor Ian Sutherland

Professor Tilli Tansey (chair)

Dr Anthony Travis

Mr Peter Turner

Mr Steven White

Professor Heinz Wolff

Apologies include: Mr Derek Coldham, Dr Keith Fairhall, Ms Pauline Field, Professor Jim Lovelock, Mrs Gill Ostler, Mr Edwin (Pip) Piper, Dr Ron Smithers, Mrs Kate Sullivan, Mr Mike Tatham, Dr Mike Worms

* Biographical notes on the participants are located at the end of the volume



Figure 1: Dr Peter Morris, Dr Anthony Travis, and Professor Tilli Tansey

Professor Tilli Tansey: Good morning everyone. Thank you all very much for coming to this Witness Seminar. This is a bit of an experiment for us. For some years we've been running Witness Seminars in recent medical history where we've had people who have been involved in particular discoveries or events come and talk about what really happened, not just what's in the published paper. Many of you will remember that Peter Medawar gave a wonderful talk about the scientific paper as a fraud, that if you just read the scientific papers, the literature, you don't really get a flavour of what really happened, how things were really done.¹

The Witness Seminar format was devised to record events in recent biomedical history, but today is slightly different because we want to have it more as a workshop; we also have some historians here who are going to provide papers, and some discussion points. We have Tony Travis and Peter Morris who are particularly interested in the history of chemistry. The whole meeting is very informal, so we want you to contribute as much as possible whenever you wish.

I'm a neuroscientist by training, and came into history quite by accident in 1986 because I was interested in history of neuroscience. That same year I got to know Bob Moore² at the NIMR because I was working on Henry

¹ Medawar (1963).

² Robert Moore was librarian at the NIMR from 1972 to 1999.

| |
|--|
| <ul style="list-style-type: none">• Role of the technician• Technical staff social life (NIMROD etc.)• Technical staff hierarchy culture• Equipment design• Laboratory techniques• Instrumentation• Health and safety• Biological Standards• Engineer support• 'Break-Away' companies• Legislation |
|--|

Table 1: Suggested themes for the Witness Seminar 'Technology, techniques, and technicians at the National Institute for Medical Research (NIMR) c.1960 to c.2000'

Dale.³ I'm actually still an attached worker at the NIMR, I go over there quite a bit, and still officially have an office there apparently, according to Frank Norman.⁴ It was through working there that I met people like Jon Marsh who was still working downstairs when I was up in the library with Bob Moore. I became very interested in the role of technicians because, as a scientist, I learnt how to do my job from technical staff, but when I read histories of modern biomedicine there weren't any technicians mentioned. So for many years I've been involved and interested in recording technicians' experiences.⁵ I have long interviews already with some of you⁶ but today what we thought – when I say 'we', I include Jon Marsh, John Sawkins, and Tony Travis, who have been involved in helping me set up this meeting – we'd like to do is try to get a grounded set of experiences, to hear you discussing among yourselves what really happened, who were the key people, who were often not the people we know most about, what were the problems? To try to stimulate some kind of discussion we divided it up simply into four chronological periods: before

³ Sir Henry Dale (1875–1968) was Director of the NIMR from 1928 to 1942. He was jointly awarded, with Otto Loewi, the Nobel Prize for Physiology or Medicine in 1936 for 'discoveries relating to chemical transmission of nerve impulses'. See pages 177–8 for biographical details.

⁴ Frank Norman was Deputy Librarian at the NIMR from 1989 to 1999 and Librarian from 1999 to 2015.

⁵ For discussions of the interviews see Tansey (2008a, 2008b and 2008c); Hartley and Tansey (2015).

⁶ Edited transcripts of interviews with several NIMR technicians will be available at www.histmodbiomed.org.



Figure 2: Professor Heinz Wolff

the 1970s, the 1970s, the 1980s, and the 1990s and beyond. In each of those periods we've actually just replicated a rather long list of the kind of issues that we thought might be important (Table 1).

They don't all apply to each period but really what we want to know is how you would like your roles at the NIMR to be remembered and what kind of historical record can we leave for future generations. So really the meeting is over to you. I'm here to try to facilitate, to help if possible in organizing the notes that we will take away from this meeting. But really it's up to you.

Before the 1970s, two of you were at Hampstead⁷ – Heinz and Rosemary. Heinz has really already put himself in the position of the first person to speak, so perhaps we could have some memories from Hampstead.

Professor Heinz Wolff: I started working at Hampstead in 1953 under rather special conditions and properly as an employee in 1954. I became a head of a division in 1962, invented the word bioengineering – I suppose it being a subject that people take at university and makes them respectable – and I moved

⁷ The NIMR occupied the former Mount Vernon Hospital, Hampstead from 1920. In 1950 most of the constituent laboratories moved to Mill Hill, where the farm laboratories were located. In 2015 the NIMR at Mill Hill closed and it became part of the Francis Crick Institute. For further details of the movement of staff and divisions, see Clayton and NIMR staff (2014).



Figure 3: National Institute for Medical Research: Hampstead. The main building is the Old Mount Vernon Hospital and the Judge Ronan building is behind the tree on the right.

to Northwick Park to run another bioengineering division in 1971.⁸ In fact, I had two appointments for a time in both places. I believe that I am probably the only person from Hampstead who is here.

Mrs Rosemary de Rossi: No, you're not. I started at Hampstead in 1949. Well, Hampstead was an old building and we weren't allowed to use the main lift unless it was absolutely essential because it was so old it just didn't work terribly well. It was very much a hierarchical situation in those days. We had separate dining rooms because there wasn't a space to have everybody together – there was one for the ladies, one for the junior technicians, one for the senior technicians, and one for the scientific staff. It was very much a separated society in those days. I don't know if you would agree on that?

Wolff: No, I wouldn't. In fact, there weren't any dining rooms at all for a time when I was there.

de Rossi: They were up on the top floor. Perhaps they'd finished by the time you joined us.

Wolff: Charles Harington was the director, of course, and actually lived in a building next door to the Hampstead laboratory so he was on the site, and I

⁸ The Clinical Research Centre; see page 72 and note 124.



Figure 4: Mrs Rosemary de Rossi

think he was a marvellous director.⁹ What I think typified Hampstead during my period, which was the mid-1950s to the beginning of the 1970s, were some very large experiments, because the MRC was committed to doing experiments for the armed services – the APRC, the Army Personnel Research Committee, and the Navy Personnel Research Committee, which involved going to Aden and setting up in the desert or having myself set free in a life raft in the Atlantic hoping that I would be picked up again at some stage.¹⁰ So there were activities at Hampstead which were totally different from the sort of activities which went on at the NIMR itself [Mill Hill]. There were climatic chambers being built at Hampstead where it was possible to produce any climate from the Arctic to the tropics – really large and expensive installations.¹¹ So there was a bit of the MRC which, though it was NIMR, did things that were really quite different and involved technicians in quantity who went abroad and flew with Britannias to Aden and went to bordellos in Aden – that is not part of the official history.

Tansey: I think those are the stories we might want to hear.

⁹ Charles Harington (1897–1972) succeeded Henry Dale as Director of the NIMR in 1942, a post which he held until his retirement in 1962. For further information see the biographical notes on page 178.

¹⁰ For projects involving the armed forces see Clayton and NIMR staff (2014), Chapter 18, pages 294–5.

¹¹ Otto Edholm (1909–1985), Head of the Division of Human Physiology at the NIMR from 1949 to 1974, commissioned the construction of climatic chambers to conduct research in cold and extreme conditions. See Clayton and NIMR staff (2014), Chapter 18. For Edholm, see Anon. (1989).

de Rossi: The move from Hampstead to Mill Hill was quite traumatic too because we had to pack literally everything up in tea chests and it was all transported to Mill Hill. Everything had to be labelled and as there were still shortages after the war in those days, there wasn't a lot of money to replace equipment so we couldn't throw anything away; it all had to go with us.

Tansey: What date did you move, Rosemary?

de Rossi: Oh, it must have been possibly 1950. I'm not really sure.

Tansey: But your department stayed at Mount Vernon, didn't it, Heinz, at Hampstead?

Wolff: Let me quickly tell you how I got there at all. It was all to do with the generosity of the MRC, which I think ought to be documented. I left school in 1946 and I was going to do a degree in chemistry in Oxford, where I had a place. I got a postcard one day saying could I possibly do it a year later because all the ex-servicemen were coming back. I got myself a job at the haematology research unit, which was MRC money but not strictly speaking an MRC unit, run by a man named Gwyn Macfarlane, who was one of the haematologists.¹² I invented a machine for counting blood cells, threw out my chemistry ambitions, and taught myself engineering and electronics for four years in a sort of autodidactic way. I then went up to an MRC unit at the Pneumoconiosis Research Unit (PRU), to count dust particles, which were supposed to be similar to red cells.¹³ Then the MRC said: 'Look, Heinz, you have to become respectable in some ways, you know. You haven't got a degree, you've got a high school certificate. You can go to any university and you can take any degree you like and you don't have to come back to us, but the only thing which we impose on you is that every long vacation or any vacation you work in a different MRC unit so you know what the MRC is all about.' I worked at King's College in the 'Double Helix year', for the losing team.¹⁴ It was very interesting. The second year I went to the Division

¹² Professor Robert Gwyn Macfarlane (1907–1987) was appointed clinical pathologist to the Radcliffe Infirmary, Oxford, in 1940 and Radcliffe Lecturer in Haematology in 1948. He was Director of the Medical Research Council Blood Coagulation Research Unit, Churchill Hospital, Oxford, from 1959 to 1967. See Born and Weatherall (1990); also the Witness Seminar on haemophilia: Tansey and Christie (eds) (1999).

¹³ See the Witness Seminar on the Pneumoconiosis Research Unit: Ness, Reynolds, and Tansey (eds) (2002).

¹⁴ In the early 1950s the labs of Maurice Wilkins and Rosalind Franklin at King's College London and Francis Crick and James Watson at Cambridge University were rivals in the development of a model of the structure of DNA, 'Double Helix year' referring to Crick and Watson's double helix model published in 1953: Watson and Crick (1953).

of Human Physiology at the National Institute. That's how I got myself into the National Institute. I was still a student at the time but I got so interested in what I was doing that I worked every spare minute that I had; with present security it seems unthinkable that I was actually given a key to the National Institute so I could work weekends and do things. The reason I had to do things was because Field Marshall Slim had been to Sandhurst and said, I'm sure quite harmlessly: 'The recruits look a bit peaky.' The War Office and the Medical Research Council went into an absolute flat spin because National Service was still in existence and there might be a whole generation of young men who were being malnourished. The MRC was given the job of measuring the input and output as far as the National Service recruit was concerned. This was my first job, to devise equipment to be able to do that on hundreds and hundreds of soldiers, and that was my introduction to the NIMR.¹⁵ You agree this is rather different from the much more fundamental kind of work which was being done at Mill Hill. And there were other experiments of that sort of nature.

Tansey: It's almost as if Hampstead was a sort of autonomous republic of the MRC to some extent.

Wolff: I think to some degree it was. It traded to some extent on the fact that Henry Dale and G L Brown, and all the greats, had worked there at one time or another.¹⁶ The laboratory called F3 had a phone box outside. The only phone box outside was in the corridor because Sir Charles did not believe that scientists needed telephones and it was a sort of distraction for them from their work. My immediate director was a man called Otto Edholm, who was a human physiologist¹⁷ interested in body temperature and climatic physiology but relatively soon, in the very early 1960s, I was given a division of my own and a building was built for me, which possibly still exists in the grounds. This was when the Institute of Bioengineering was created, which has existed ever since, and in which Ian [Sutherland] worked, and was a director of for a time.

¹⁵ Professor Heinz Wolff invented a portable instrument to measure oxygen consumption of the recruits – the integrating motor pneumotachograph – which could be worn in the field and gave accurate results: Fletcher and Wolff (1954). This account is reported in an interview with Heinz Wolff in the *New Scientist* in 1984: Aker (1984).

¹⁶ For Henry Dale see the biographical notes on pages 177–8. George Lindor Brown (1903–1971) worked at the NIMR from 1934, taking over from Dale as Head of the Laboratory of Physiology and Pharmacology in 1942. He left in 1949 having been appointed Jodrell Professor of Physiology at UCL: MacIntosh and Paton (1974). This period is commemorated in a spoof film, *Let's get an Effect*, see Tansey (1995).

¹⁷ See note 11.



Figure 5: Mr Ian Mathison

Tansey: It's interesting you mentioned Hampstead. One of the people I have interviewed at length in the 1990s and early part the 2000s was Len Ward.¹⁸ Len, whom many of you will know, has drawn me floor plans of Hampstead. He turned up one day with wonderful scale drawings of Hampstead; it was fantastic.¹⁹

Rosemary, can I just ask you: one of the things you mentioned was this hierarchy and the different dining rooms, which I've heard from other people before. What happened when you moved from Hampstead to Mill Hill, did that continue?

de Rossi: No, it completely changed. The fifth floor was almost all canteen and all members of staff had to go in there and queue up for their dinners, even the Director. But you had to be dressed properly – the gentlemen had to have ties, shorts weren't allowed, and ladies weren't allowed to wear trousers. But it was a beautiful view because it was high on the hill and you had a fantastic view out of the canteen windows.

Mr Ian Mathison: I started in 1953 and I've just made a few notes here – the canteen on the north side, which was the shady side because that was the north side of the building, that's where the scientific staff sat, and the technical staff

¹⁸ Mr Leonard Ward was a technician at the NIMR from 1928 to 1976; Professor Tilli Tansey conducted several interviews with him in February and March 1994, excerpts from which are reproduced in Tansey (2008a) and an edited transcript of the interviews will be available at www.histmodbiomed.org.

¹⁹ See Appendix 1 for the floor plans of the ground and first floors of the NIMR at Hampstead. Further drawings are available online with the pdf of this volume: www.histmodbiomed.org.



Figure 6: Mr Jonathan Marsh

and ancillary staff sat on the south side, which was rather warm when the sun was out. There were also staff coffee rooms – the scientific staff coffee room was also on the north side; technical staff coffee room and ancillary staff coffee room was on the south side, and that was filled with Lloyd Loom chairs, I seem to remember, and tables. On my first day I wasn't sure where to sit and I made a mistake – I sat with the Head Technicians and they wondered who I was. But I soon corrected that and sat regularly with the other more junior technical staff. I remember that faux pas.

Tansey: How long did this division last?

Mr Jonathan Marsh: I think that lasted until Medawar decided to change everything.²⁰ I think, and Ian can correct me if I'm wrong, that the two separate coffee rooms on the fifth floor lasted until the fifth floor became labs and the North Building was built.²¹ Is that correct?

²⁰ Sir Peter Medawar (1915–1987) was Director of the NIMR from 1962 to 1971. For his time at the NIMR see Brent (2009), and for further biographical details see pages 180–1.

²¹ The fifth floor, which had housed the canteen and two coffee rooms, was converted to accommodate the new Genetics and Developmental Biology Divisions, which moved in in 1970. The new North Building, finished c.1969, was built over the stores and accommodated the Engineering Department, personnel department, supplies office, the administrative side of building services, and also provided new seminar rooms, a dedicated area for NIMROD (with table tennis and a snooker table), a bar, and the new canteen. Information supplied by Mr Ian Mathison, telephone conversation with Ms Caroline Overy, 27 January 2016. See further comments by Mr Mathison on the fifth floor conversion on page 38.

Mathison: That is correct, yes.

Marsh: Going back to what Heinz was talking about. I wanted to ask him a couple of questions. I started working for Frank Hawking and Neil Brown²² in Chemotherapy but after five years I went to work for John Lewin whom I worked with for a long time.²³ One of the things that he and I did was to work for Griffith Pugh who went on the 1953 expedition up to Everest with Hunt.²⁴ In 1968 Pugh, who worked at Hampstead, came to us in Mill Hill and John and I worked for him making the kit for the Mexican Olympic Games, which was to monitor the runners. It was at high altitude and he wanted to see how the runners performed, and we made some kit to measure three things: their temperature, respiration rate, and pulse rate.²⁵ What I don't understand is why you didn't do that, Heinz, because Pugh was at Hampstead, you were at Hampstead; I've never really understood why Pugh came to us for that, and maybe you can shed some light on that?

Wolff: I don't know. I knew Pugh quite well and some of you may know that Pugh's daughter has written his biography.²⁶ It's not necessarily a very friendly biography but it is an accurate one and shows the total social toffee-nosedness of the climbing establishment, where if you hadn't been to the right school you couldn't really be a climber. By 1968 I was pretty well involved in quite large and complicated things at Hampstead.

²² Dr Frank Hawking (1905–1986) was head of the Division of Chemotherapy (later renamed Parasitology) at the NIMR from 1950 until his retirement in 1970; see Anon. [PJW] (1986). Kendrick (Neil) Brown (1929–2012) worked on malaria and trypanosomiasis in the Division of Chemotherapy from 1960 until his retirement in 1995; see Clayton and NIMR staff (2014), pages 260–2.

²³ Mr Jon Marsh wrote: 'John Lewin was a design electronics engineer at the NIMR and member of the technical staff in the Department of Engineering. He was responsible for many innovative solutions using electronics to tackle medical research experimental requirements. He also developed the apnoea alarm to warn nursing staff of an attack of apnoea in premature babies.' Email to Ms Caroline Overy, 23 October 2015.

²⁴ Colonel John Hunt (later Lord Hunt) (1910–1998) led the 1953 Mount Everest expedition; the research on altitude medicine and physiology by the physiologist Griffith Pugh (1909–1994), led to the success of the expedition. Pugh worked in Otto Edholm's Division of Human Physiology from 1950 until his resignation in 1967, after which Peter Medawar gave him an independent Laboratory for Field Physiology. See Tuckey (2013).

²⁵ Pugh had studied six long-distance runners in Mexico City for a month to assess the effect of altitude on performance: Pugh (1967). For discussion of his research into athletes and altitude and the Mexico Olympic Games, see Tuckey (2013), pages 278–98.

²⁶ Tuckey (2013). See also, Tansey E M (Tilli) Pyjamas on Everest and in the lab – tales from the National Institute for Medical Research at www.histmodbiomed.org/blog/pyjamas-everest-and-lab-tales-national-institute-medical-research (accessed 26 April 2016).

Marsh: I think that's probably what it was about because, if I remember rightly, we used to come to Hampstead and I think there was a radio pill you were involved in? And there was this SAMI thing that you were also involved in. SAMI, socially acceptable monitoring, or patient monitoring, [instruments].²⁷

Wolff: What a remarkable memory!

Marsh: I don't know about that, but I've asked Pip Piper²⁸ about this and he thinks a similar thing, he thinks that you were too busy to work with Pugh. We'd already apparently worked for Pugh and John Lewin had worked for him on something before this. But just going back to the Mexico Olympic Games – it was really rather good fun because we had a student from Egypt. We worked on the sixth floor then, it was only John and I doing electronics but we used to get students in and try to teach them a bit of electronics and then send them back to the colonies to do electronics, you know – jolly good Empire stuff. We had this chap, he was quite fat, and we had him running up and down the Ridgeway in the summer and he had this kit on his back, which was the transmitter. John and I were up on the roof of the Institute with the receiver and we could receive all this temperature information; it was all coming through and worked perfectly. Of course, it went off to Mexico with Pugh and when it got there they discovered the local radio station had the same frequency as our radio link and so nothing worked at all. My experience was that, quite frequently when making things, they didn't work when you finished them. They had to come back and things had to be changed, and that's how the development went. We got it working eventually but it didn't work for Mexico. What they should have done, of course, but they were too tight fisted, was to send John and me out to Mexico to check it all out first and that would have been a much better idea.

Wolff: Something that I'm sure you don't know is that in the 1960s the MRC at Hampstead got involved with a hypnotist called Stephen Black. The hypnotist initially performed quite well – he could for instance suppress an immune

²⁷ Heinz Wolff had designed the 'radio pill', a device that could be swallowed to transmit data (such as temperature, acidity, and pressure) from inside the body: Wolff (1961). SAMI were small lightweight instruments, worn under or over clothing 'intended to acquire information on the physiological and environmental experience of normal people over long periods whilst going about their everyday business'. Baker, Humphrey, and Wolff (1967).

²⁸ Mr Edwin (Pip) Piper (b. 1922) joined the NIMR as a junior technician in the Electronics Department where he worked for Dr Wheeler-Robertson from 1947 to 1970. From 1970 until 1982 he worked for Jack Perkins in the Computing Department. For further details of his work at the NIMR, see Dr Anthony Travis' discussion in Appendix 6. The edited transcript of an interview with Mr Edwin Piper, conducted by Professor Tilli Tansey, will be available at www.histmodbiomed.org.

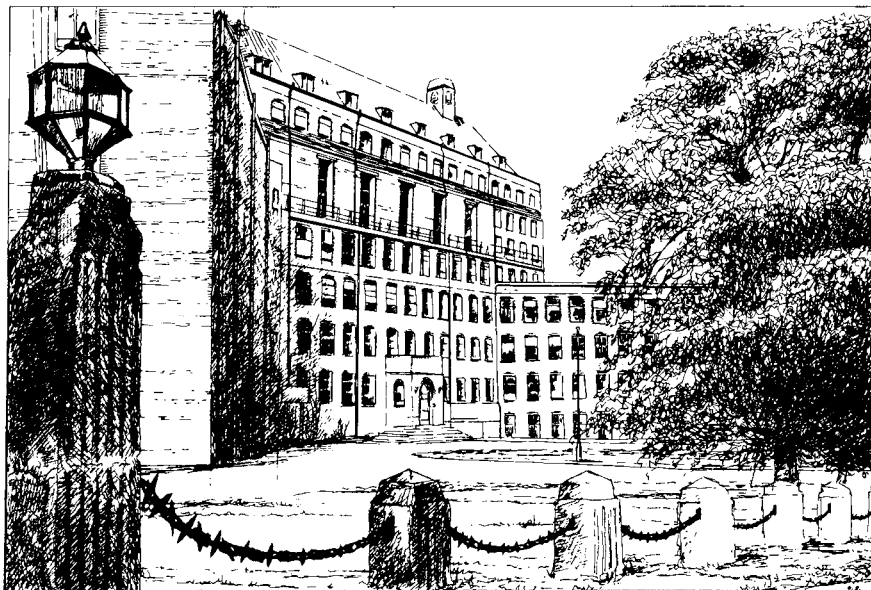

National Institute for Medical Research, Mill Hill

Figure 7: Cover of a season's greetings card showing the NIMR at Mill Hill²⁹

reaction that you got from vaccination merely by hypnotizing people.³⁰ He had subjects that were very sensitive to hypnosis but he blotted his copy book when he claimed to be able to hypnotize seaweed, which was stretching people's comprehension a little, and then disappeared. Stephen Black was a well-known performer in music hall, and well-known performer on the BBC, and I think probably quite a talented man. He just got it wrong.

Those of you who haven't read the Pugh biography, it's well worth reading.³¹ It gives a picture of the background of science as far as society was concerned, particularly the climbing society, which I think had never been recognized before.

Tansey: This is a very rich story about medical research at the time. Can I go back to some of the points we've already raised: there's a transition from Hampstead to Mill Hill, then quite a few of you joined straight at Mill Hill,

²⁹ The card is from 'The Trustees of MRC Pension Trust Ltd' and probably dates from the 1980s. The artist is not named. Image and information supplied by Dr Anthony Travis, email to Ms Caroline Overy, 19 January 2016.

³⁰ See, for example, Black (1963); Black and Friedman (1965).

³¹ Tuckey (2013).

so you don't have that experience that Rosemary's talked about of Hampstead. What about those of you who started in Mill Hill perhaps in the 1960s or earlier? What did you feel about the atmosphere at Mill Hill?

Mathison: This is a bit about the hierarchy if I may add this. Having just finished my National Service, I fitted into the system quite well because I considered the 'other ranks' were technicians, ancillary staff, works and maintenance, engineers etc. The sergeant majors were the head technicians, heads of work and maintenance, the A men; and the officers were the scientists, head of administration, personnel officer; and the commanding officer, of course, the heads of division; and 'Sir', the Director. He was the only person we called 'Sir'; all the doctors we called 'doctor'. You probably know about the green coats worn by the glassware cleaners? Technicians wore brown coats, scientists and head technicians wore white coats. And the theory is that that was stopped because they found that white coats were cheaper because they bleached all the coats and then dyed them, so having white coats being cheaper they changed over to that. But I'm sure that wasn't the only reason.³² Now I remember the head of administration we had then was a slightly built but formidable General Brunskill – I should think Rosemary de Rossi remembers him – and he was well known for his edicts, which he would place on every division's notice board. He'd always start it off: 'It has come to my notice that...' And, of course, there were new teak benches and teak doors, everywhere was covered in teak, and people had been putting screws and nails into the teak bench so he sent around a notice about that. The rather amusing one, too much crockery was being withdrawn from the stores, and he sent a notice saying: 'It has come to my notice that too much crockery is being used. Every technician and scientist should be covered by one cup.' And Dr H J Rogers, Howard Rogers, with whom I worked then in the Bacterial Chemistry Division, drew in the space underneath this edict a very, very large cup with four feet sticking out.³³

Marsh: Yes, one little thing that happened before Medawar came: we used to have a tea trolley that came round to everybody. We used to drink our tea in the labs in those days, and our tea lady, Margery, would come tinkling up the corridor with the tea trolley and we'd all have tea. You could order buns and things, as well. It was jolly good. But when Medawar turned up he thought everybody should sit together at tea time and he put a stop to all that. That was

³² See comments about lab coats in the technician interviews reproduced in Tansey (2008a); Hartley and Tansey (2015).

³³ Howard Rogers was head of the Microbiology Division; he retired in 1984.



Figure 8: Mrs Hilary Morgan

when the new restaurant was built on the ground floor and we were all meant to go down there and drink at the bar and interchange scientific thoughts and all that sort of jazz, which was a jolly good thing, I expect.

Mrs Hilary Morgan: Yes, it wasn't just at the NIMR that you had this hierarchy because, having started there, I then went in 1961 and worked at the Imperial Cancer Research Fund next door. There we didn't have a canteen as such so we went to the Institute for lunch. But the scientific staff sat in their nice armchairs in the library for their tea breaks. We had a kind of Black Hole of Calcutta for the ladies and the men just used the kitchen for their coffee. So again it was standard practice, it would seem, to divide people up at break times.

Dr Peter Morris: I would just like to make a similar point because while the issue of hierarchy at the NIMR was very interesting, it was absolutely standard for what you might call Civil Service organizations at the time. Exactly the same would have been true at the Science Museum, for example, with warders and workshop technicians at the bottom, museum assistants in the middle, and curators and keepers at the top. Exactly the same kind of hierarchy. I'm not sure about the breaks because obviously this was all long before my period but certainly there would have been a very, very strong sense of hierarchy.³⁴ In fact most of the warders would have been ex-army anyway.

³⁴ Professor Tilli Tansey confirmed this point in that when she started her PhD in Sheffield in the mid-1970s, a similar hierarchy existed between scientists and technicians.



Figure 9: Dr Peter Morris

de Rossi: Just thinking about Sir Charles Harington, although he never, ever spoke to the lower forms of life, putting it that way, he knew everybody's name because we used to have open evenings where parents could come round and see what their children were doing, and they allowed the press in.³⁵ I was absolutely disgusted when he told my mother and father that I was doing terribly well because I wasn't sure he particularly even knew me. He'd never spoken to me but he knew everybody's name and he kept a finger on everybody even though he appeared to be completely aloof in some ways.

Marsh: Yes, Charles Harington did keep his eye on you. I'll tell you a little story: when I started I was in Hawking's division in Chemotherapy; I was sent to Brunel College at Acton to do Applied Biology HNC. I think by that time I was a Technical Officer (TO) and TOs were given day release to go to Brunel and it was a privilege.

I messed around a bit too much and used to go skating at Richmond with the girls instead of going to all the classes, and the upshot of that was when it came to the exams I failed one of them. I had to go and see Sir Charles about getting this day release because I had failed and was in his black books. And he said to me: 'Ah Yes. Are you that young chap I've seen tearing round in that MG?' So he'd spotted who I was, he sort of knew me, I'm not sure he'd have known my name. Also, I think we had to get out of the lift, didn't we? If he got into the lift we had to get out.

³⁵ See also the discussion on open evenings and open days on pages 120–4.

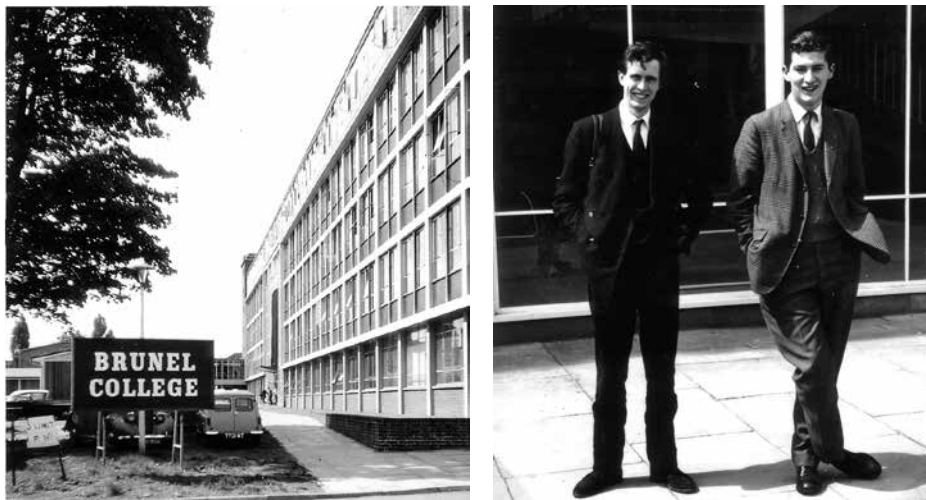

Figure 10: Brunel College of Advanced Technology in 1963 and Mr Jonathan Marsh and a colleague studying for Higher National Certificate in Applied Biology at Brunel in 1964.

de Rossi: Oh, definitely. Yes I can remember one day the lift was full and I think Bernard Price was standing in the front and Sir Charles just stood outside the lift and beckoned him out, never said a word. So poor Bernard had to get out and he got in. The lift was always overcrowded because they were far too small really for the number of staff using them.³⁶

Marsh: Well, it didn't work most of the time, did it?

de Rossi: No, it was overworked basically because it used to have to take all the stores and everything else as well as people at that time, before they built the new lift, if you remember?³⁷

Marsh: One of the things about the 1960s that probably many of you won't remember because you weren't there was that we used to have to sign in. There were these books by the door. You had to get to the book and you had to sign it, and after that there was a late book.

Mathison: First of all the signing in books were put out there and taken away at ten to nine. The lady who then took those books away and put out the late book, which remained there until about half past nine, used to walk up Bittacy

³⁶ Mrs Rosemary de Rossi wrote 'I think Bernard Price joined the MRC in 1949. He worked in the Division of Biological Standards until he retired.' Letter to Ms Caroline Overy, 21 July 2015. For a discussion of the status of technicians at the NIMR see Tansey (2008a).

³⁷ See further discussion on the lifts on pages 111–13.

Hill, and all the technical staff were under very strict instructions not to give her a lift for obvious reasons. Now I was told very early on that one of the tricks is just to walk straight through. If you are late don't sign anything and when Personnel phone up to the Head Technician and you're asked, well, whether that person is in or not, you just say: 'Oh I'm sorry, I forgot to sign the book when I came in.' But that trick was only to be used once.

Marsh: The other thing we did in the old days was we had to work on Saturday mornings – I think it was 8.45 to 5.30 on weekdays and then Saturday mornings 9.00 to 12.00. I remember in those days I was still in Chemotherapy and one of the jobs I had to do on Saturday morning was passage the strains,³⁸ which meant taking some blood from a mouse, diluting it down, and injecting it into other mice. I was working on trypanosomiasis in those days with Neil Brown, and you had to dilute the blood so, with a bit of luck, one of the mice that you injected would survive until Monday; then you could passage the strain again and Monday to Wednesday wasn't so bad. But sometimes I'd get in on a Monday morning and everything was dead. But that's another story.

Wolff: I am surprised that you all have a rather bleak view of Sir Charles. I didn't and I'll tell you about a particular occasion. He wasn't a man who laughed very much and after I'd been there for a couple of years I made it my purpose to get him to laugh. I'd just been presented with this new building and Sir Charles and various other dignitaries were coming to open it, and I hired for £3.10.00, this is Imperial currency [£3.50 in current terms], a stuffed bear and put him just round the corner of a passage at a T junction. Sir Charles walked down there and encountered a notice which said 'Bear to the Right' and he laughed, and spent the rest of the afternoon persuading other dignitaries to be exposed to the same experience.³⁹ So the view we had of Sir Charles, who used to come and see us occasionally, was a much more parental, nice, fatherly figure. I had an enormous respect for him because he was a director who had already made his name before he became the Director.⁴⁰ He didn't have to use the Institute to make his name. That is, I think, a very important property that a successful director has to have. So I was really very fond of the man but there were no negative effects to my practical joke.

³⁸ A process that allows microbiological cultures to keep growing. These could be protozoa, bacteria, or viruses.

³⁹ Mr Ian Mathison wrote 'I remember seeing this notice and the bear during one of my visits to Hampstead.' Note on draft transcript, 18 November 2014.

⁴⁰ Charles Harington had been made a Fellow of the Royal Society in 1931 and was Professor of Chemical Pathology in the University of London from 1931 to 1942.

Morgan: I think one of the reasons people were slightly in awe of Sir Charles was that he wore his black jacket and striped trousers – it was kind of morning dress. It was a very formal outfit and he looked imposing and you just wouldn't mess with someone like that. I remember Eric King telling me one time that he was in on a Saturday and he passed Sir Charles who said: 'Mr King, are you on holiday?' 'No,' said Eric. 'Then put on a tie.'⁴¹

de Rossi: Yes, on Saturday mornings when we used to have to work every other Saturday, ladies weren't allowed to wear trousers and I'd cycled in and I thought: 'Ooh heck, I'm not going to bother to change this morning,' as you do. And, of course, who did I bump into? Sir Charles. He just took one look at me, he didn't say anything, and I just walked straight past and said absolutely nothing.

Marsh: Talking about jokey things, Heinz, you may remember this. I don't remember it, but I was going out with a girl at the time called Margaret Dean, and she worked at Hampstead, she was a technician there. She tells me a story about you and it was April 1 – I don't know what year it was – and you were giving a talk. You asked her to pose at a microscope measuring something and you stood up and gave this talk about calibrating crickets. It was one of your jokes and nobody realised it was a joke until you started. But it was done on April 1st.

Wolff: Are you sure it was Margaret? Not Pamela Dean?

Marsh: No, Margaret Dean.

Wolff: Because Pamela Dean was Pugh's technician forever, I mean as far as we can make out, ever since Pugh had been invented, and I thought more or less died in service. She could manage Pugh, which not many people could.

Tansey: I think Jon was trying to see about this practical joke, this April Fool's joke.

Wolff: Well, practical joking is one of my hobbies.

Marsh: Yes, I thought it might be, so many of them you couldn't remember it.

⁴¹ Mrs Hilary Morgan wrote: 'At that time (1960s) the accepted dress code at the Institute was shirt and tie for the men and dresses or skirts for the women, never trousers; and certainly no shorts. Lab coats were always worn. Eric King trained as an instrument maker (this covers very small items up to really large ones) and was a member of the team in the Engineering Workshop. They would be asked by scientists for help with designing and engineering instruments for specific tasks or adapting/altering/repairing items etc. Eric had a hand in developing both the breathalyser and the slow infusion pump for delivering insulin.' Email to Ms Caroline Overy, 8 July 2015.

Wolff: I don't remember this particular one.

Mathison: I was surprised in looking back through my archives, that three years of Army Reserve Training was, of course, obligatory after my National Service, and I had to take this as unpaid leave. That was a bit surprising. So I wasn't paid for three lots of two weeks' service but at least I got unpaid leave. The alternative was that I could take it as my annual leave and I have the appropriate documents.

Tansey: What date was that, Ian?

Mathison: The document was dated 12 May 1954.

Tansey: No one has said much about what they actually did in the labs – both the things you were supposed to be doing and then perhaps some of the things that you weren't.

de Rossi: I started off in Biological Standards and I think we used to send out the standards every six months, all over the world, and they had to be packed up carefully. I was thoroughly disgusted because the first thing I was taught was how to pack a parcel. I thought: 'I've come here, never thought I would be doing this.' Staff were pulled out from the labs, we all had to take turns in doing that for a number of years. And I think they still send them out now from the National Institute for Biological Standards and Control (NIBSC).⁴²

Tansey: Were you involved in actually setting up the standards, Rosemary?

de Rossi: The only involvement I had was when I worked with John Humphrey and we put out the penicillin standards.⁴³ Most of the time I managed hopefully to avoid doing the other fillings.

Morgan: As I mentioned at the start, I worked for Rodney Porter between 1957 and 1959, and in those days we did fractionation and separation to get the gamma globulin and that was very original work.⁴⁴ We had to have columns

⁴² For a history of biological standardization, see Bangham (1999). For a discussion of biological standards at the NIMR, see Clayton and NIMR staff (2014), Chapter 14.

⁴³ John Humphrey (1916–1987) joined the Division of Biological Standards in 1949 and was appointed head of the Division of Immunology in 1957. He was Deputy Director of the NIMR from 1961 to 1976, after which he was Professor of Immunology at the Royal Postgraduate Medical School, until his retirement in 1981; see Askonas (1990).

⁴⁴ Rodney Porter (1917–1985) worked in the Biochemistry Division of the NIMR from 1949 to 1960 when he was appointed to the Chair of Immunology at St Mary's Hospital Medical School. He was awarded the Nobel Prize for Physiology or Medicine (jointly with G M Edelman) in 1972 'for their discoveries concerning the chemical structure of antibodies'; see Perry (1987).

that we passed the material through and then it was collected in a fraction collector. This was infuriating because the drips went into a little syphon and when it moved over there was a mercury switch and the fraction collector would move on one place – I didn't understand all the intricacies of this.⁴⁵ It frequently flooded and you'd come in in the morning to find about three litres of water or buffers all over your fraction collector and maybe it had shorted out as well. These columns were about 3ft long and you look now at the things for fraction collectors and they're kind of 3cm if you're lucky and presumably they don't flood anymore. But I found a paper when I was checking back about the frustrations of someone who was doing this work in a cold room and they spent all night in there watching these damn columns making sure they didn't flood.

Tansey: How did you solve the technical problem?

Marsh: The mercury switch and syphon collectors were there in the early 1960s. Then in the mid-1960s John Lewin, whom I was working for at that time, decided that the way to do it would be to count the drops rather than to have the syphon, which would probably get rid of the flooding problems and also would stop the contamination from sample to sample, because a syphon would always have a bit from what was left from the previous few drops. I don't know whether John Lewin invented that or not, but I think he did. It was one of those things that you used a photo cell and a light source and a little thing that counted the drops going through, and after you could set the number of drops so that would be the size of the fraction you wanted and then it would move the fraction collector round in the same way as the mercury switch had done and that was that.⁴⁶ That's an example of one of the things that was then moved on to be manufactured in a company called Medical and Biological Instrumentation

⁴⁵ See also Appendix 2.

⁴⁶ Mr Ian Mathison wrote: 'About 1954/1955 referring to fraction collectors; I remember seeing (but not using) an old fraction collector, which consisted of a circular test tube rack about 12" diameter, made from wood. This was capable of holding at least 50 test tubes (size about 5" long x 1/2" external diameter). The rack was advanced stepwise by a system of cogs and a ratcheted wheel and the power source was provided by a weight and pulley system (as used in old pendulum clocks). A glass syphon (usually 5 ml or so) was positioned under the glass column and when full, emptied into the tube below; the syphon mounted on a balance beam was now lighter than the counterbalance weight, and the movement of the beam released a ratcheted cog wheel and the drum rotated to bring the next tube in line. NO ELECTRICITY REQUIRED! This system was soon improved and was motor driven. However, the syphon system was prone to flooding (as described by Hilary Morgan) and was replaced by the drop counting method. I tested prototypes of these and reported back to Jon Marsh and Frank Doré.' Note on draft transcript, 18 November 2014.



Figure 11: The fraction collector.

(MBI).⁴⁷ That was started by a couple of people from Electronics – Bill Perrin and Mike MacDonald. They started this company up and MBI then supplied drop counting fraction collectors – I guess they're available from all sorts of people nowadays, I've no idea. But that was an example of a bit of development of technology that helped. I remember these columns were quite often in the cold room, right up by the door.

Dr Anthony Travis: I'll just make one remark, if I may, and go back to Jon because this is relevant to your earlier comment. From an interview I had with Jon he did emphasize that the device he just mentioned was a world standard design; it was adopted in many laboratories here and abroad. And as you pointed out rightly, and I'm aware, this is the case for many other instruments and devices developed at the NIMR.

Marsh: Yes, that was probably when I was bragging to you a bit, Tony, in a less formal environment. [Laughter]

Wolff: Nobody has mentioned Rhesus monkeys. The whole development of polio vaccine was done at Hampstead, which required an animal house full of Rhesus monkeys, which escaped every so often to Hampstead. Nobody much noticed because the inhabitants were not all that different. [Laughter] But the Rhesus monkeys were quite skilful at getting out because they had nothing else

⁴⁷ See further comments on MBI on page 50.

to do but fiddle around with the locks on their cages and so on. So the polio vaccine was a very large and important function of the Hampstead laboratories which so far has not been mentioned. And yet somebody must know about it.

Marsh: I hope I can get this right and I think you've seen this story, Tilli, anyway. The animal building at Hampstead was called the Ronan building and that was because of the money that came from the Ronan Foundation; it was an Irish family, I believe, who left some money.⁴⁸ Anyway the chap in charge of the animal division there was Doug Short and his son was Ron Short – I understand that he's called Ron [Ronan] after this Ronan Foundation but that may or may not be true;⁴⁹ I've always said it was true. Going back to the monkeys, Ron came over from America about eight or nine years ago and told me a story. He's told it to me twice and it's been different on both occasions but it's more or less the same story. I think three monkeys escaped from the animal division and were out swinging in the Hampstead trees and this was reported to Doug Short. They went out with a load of bananas and stuff and they managed to coax two of these monkeys back into the cages with these bananas, but the third monkey was reluctant to go back. So they shot him with a shot gun and that was that. Then about a week later, I think, Doug Short was called in to see Henry Dale, who was the Director then – this is in the Hampstead days so it was before my time. The Prime Minister lived nearby and Dale must have been to dinner with him and the Prime Minister had reported hearing these shots, and wanted to know whether it was anything to do with the Institute.⁵⁰ Dale said it wasn't. But then he called Doug in and said: 'I've heard this report about shooting. Do we know anything about this?' Doug apparently said: 'No, no, nothing to do with us, Sir', and, as he was walking out the door, the Director said to him: 'Did you get the blighter?' Doug Short said: 'Yes, sir.' And he said: 'Well done, Short.'

Mathison: In November 1953 I started to work as a Junior Technician in the Division of Bacterial Chemistry. After my obligatory two-week stint in the Media department, I was assigned to Dr Howard Rogers' lab to assist in the study of bacterial enzymes, in particular, hyaluronidase. Some interesting

⁴⁸ A bequest from Stephen Ronan (1848–1925), Lord Justice of Appeal and Privy Councillor in Ireland, was used to construct the Ronan Building to house small animals and monkeys. This was finished in 1928 and was connected to the main NIMR building (see Figure 3, page 6).

⁴⁹ Douglas Short was Principal Animal Superintendent of the Animal Division from 1944 to 1970.

⁵⁰ Ramsay MacDonald (1866–1937) was Labour Prime Minister in 1924 and from 1929 to 1931; he then led the coalition government from 1931 to 1935.

collaborative research ensued, involving Dr Parkes from Experimental Biology,⁵¹ who saw the possibility of a male contraceptive if we could invent an inhibitor of hyaluronidase produced by sperm, and Professor Lack from the Royal National Orthopaedic Hospital, who was researching the role of synovial fluid hyaluronidase in osteoarthritis.⁵² Dr Spensley, from Organic Chemistry, provided us with an inhibitor, which he called ‘53K’. Very effective *in vitro* but lethal to mice *in vivo* – you can’t get a more effective contraceptive than that!⁵³ I’m not sure whether my many weeks testing slices of cartilage from Professor Lack’s patients were productive. Potassium hyaluronate, the substrate for hyaluronidase, was horrendously expensive, so we made our own from umbilical cords. We also made our own chondroitin sulphate and glucosamine, not imagining the time would come when they would be available in tablet form in health shops. After three years or so we changed to work on antibiotic resistance.

Morgan: One of the Saturday jobs that we did: we took great pride in our beautiful teak bench in our room, and we used to polish it religiously every two weeks. I think I had to go in every other Saturday, and we used to go and get the floor polisher and you could see your face in this bench at the end of it – it looked really good. I remember we had a very nice washing-up lady who seemed, to me, rather superior. Does anyone remember a Mrs Topham? No? She must have been unique to us. Of course, in those days to get the glass really clean we used chromic acid, in baths on the side of the draining boards, which would definitely be frowned upon nowadays.

de Rossi: I quite agree. Everything had to go through chromic acid and you had to be very careful with it. The work that we were doing in the 1970s was mainly with animals, working out the immunization for babies using baby rabbits. We also did some radioactive work with chickens – Amersham gave us the radiation to do it with and we wanted to make ¹⁴C radioactive albumen. We watched these chickens for weeks with their ovulation and when they laid their eggs, and then we fed them. Trying to feed them the ¹⁴C wrapped

⁵¹ Sir Alan Parkes (1900–1990) was head of the sub-department of Physiology and Sex Hormones (later the Division of Endocrinology, and in 1945 the Division of Experimental Biology) from 1932 to 1961, when he moved to the University of Cambridge as Mary Marshall Professor at the Physiological Laboratory. For his time at the NIMR see his autobiography (Parkes (1985), pages 49–72).

⁵² Lack and Rodgers (1958). Professor Charles Lack (1909–1991) was appointed the first consultant pathologist at the Royal National Orthopaedic Hospital in 1948.

⁵³ Parkes (1953).

in bread was difficult. We had to feed them so they all stopped laying. We had to unfortunately kill them all to extract the material. But it was quite an interesting experiment even so.⁵⁴

Marsh: Talking about the animals; of course, in the 1960s the animals were mostly in the main building at the west end, the first and second floors, and there was an animal lift, which is not there now. We also had the farm where we had some animals – sheep and calves.⁵⁵ I used to have to go down and get blood from these – I’m sure it wouldn’t be allowed now – I didn’t have a licence or anything but Neil had a licence so that was alright.⁵⁶ I was sent down. I remember going down there one day with Dr Hawking and Ken Gammage to catch this sheep in the field, which we needed to get blood from. I remember it running and there was old Dr Hawking there saying: ‘Arr, arr, I’ve got it, I’ve got it, Gammage, I’ve got it!’ and it ran right between his legs and he fell over into a load of ... [Laughter]

But the chromic acid, yes, we had to make that up, which was something we did on a Saturday morning as some of it went in the chromic acid tank and some of it went down the front of my lab coat. The other thing we did on a Saturday was to pull and plug the Pasteur pipettes⁵⁷ and they were all then put in those nice copper tins and then sent up to be sterilized in the media room.

Many years later, a little anecdote perhaps I shouldn’t tell, Rod King⁵⁸ and I used to come to work in the car together and there was a dump at work where everything we didn’t want was thrown. On a Friday night we used to have a look at the dump, and if there was anything that looked quite nice we’d stick it in the back of the car and then, at the weekend, I would take it all to bits and

⁵⁴ Mrs Rosemary de Rossi wrote: ‘It was the first radioactive albumen made; Amersham had half [in return] as they had given us the ¹⁴C.’ Note on draft transcript, 8 September 2014.

⁵⁵ The land at Rhodes Farm, Mill Hill, was acquired by the NIMR in 1922 to establish the field/farm laboratories for animal breeding and research.

⁵⁶ The 1876 Cruelty to Animals Act regulated animal experimentation. Properly qualified individuals required a personal licence, premises had to be registered, and people, places, and procedures were open to random inspection by the Home Office. This legislation was replaced by the Animals (Scientific Procedures) Act of 1986; see www.legislation.gov.uk/ukpga/1986/14/contents (accessed 29 April 2015).

⁵⁷ Glass Pasteur pipettes were made by heating a glass tube in the centre and pulling apart until it snapped to make two fine-ended pipettes.

⁵⁸ Rodney King worked in the Division of Molecular Pharmacology working on enzyme kinetic studies; he later became Director of Studies at the NIMR.

divide it into ferrous and non-ferrous metals and heaven knows what, and on Monday morning we'd drop into the scrap yard in Smallford in St Albans and sell it all and that would pay for the coffee and tea for Ronan Cottage. But one night Rod had discovered they were throwing away all these copper cylinders that the sterilizing had been done in and he'd got a whole load stashed in his lab. We were carrying them out, and Rod was very nervous about this; I said: 'They're going to throw them away, Rod, it doesn't matter, you know, it's all good recycling stuff.' And he said: 'Well, I'm a bit worried. But you open up, I've got a whole load here', and we were just about to go out, he put his car especially round at the east door so we could creep out of the east door and put them in the boot of his car, and suddenly the door opened and it was the Director Dai Rees⁵⁹ who held the door open for Rod as he was carrying this scrap to his car.

Mathison: This is a story about chromic acid in Tommy Work's lab, which was near to my lab on the first floor.⁶⁰ A young technician, luckily very lightly built, called Annette Pearson; she had quite a serious accident – while she was making up chromic acid, it spilt all down her front, and one of the visiting scientists just lifted her bodily into the Belfast sink; luckily these very big sinks were large enough and he turned all the taps on. So she then, of course, had to change into other clothes. That was quite a dangerous accident. Another one is about the wax. There was lots of this wax on the cork floors in the Institute, (we're now talking of the 1950s and 1960s) and if you dropped any water on the floor it was extremely slippery. We had to have a cold room clear out every now and then to remove all the tubes and boxes and stuff. I remember having a big clear out and I had all these empty boxes, and a technician called Ruth Coyle was standing in the first floor corridor holding the double doors to the cold room, helping me. This mountain of boxes started to get out of control, rather like the game Jenga where you take the bricks away, and she kept telling me that the boxes were about to fall. In trying to get stability I widened my stance and eventually did the splits because there'd been some water on the floor; realising that I was going to damage the base of my spine, I threw all the boxes, quite a number of boxes, straight in the air, put my hands under my backside for safety

⁵⁹ Sir Dai Rees (b.1936) was the Director of the NIMR from 1982 to 1987 and Chief Executive of the MRC from 1987 to 1996.

⁶⁰ Thomas Work (1912–1997) joined the NIMR in 1938. In 1956 he was appointed Head of the Division of Biochemistry and was Deputy Director of the NIMR from 1975 until his retirement in 1977; see Clayton and NIMR staff (2014), page 82.

and then was hammered by all the boxes, which came down on my head. A lot of people came out from the labs and wondered what was going on. That was another experience at the Institute.

de Rossi: Can I also mention about chromic acid. We used to make ours in a large evaporating dish about 2 ft across. We had just made it, and chromic acid gets very hot when you're making it. It had been carefully put on the table after we'd made it and somebody accidentally knocked it and it went all over the floor, all over everybody who happened to be in the room at the time. Of course, there was obviously a major clear up then and I can remember my shoes rotted and I'd got holes in my clothes all down my back – we had a real fight to get any money to buy new clothes because the MRC was quite tight with their money on paying for replacements.

Tansey: I think these experiences you mention raise another issue, which is very contemporary, of course – Health and Safety. Were there any internal regulations and rules you followed?

Marsh: Yes, well, we eventually had safety committees. I was actually chairman of the safety committee for a short while and had to preach all this stuff, which I didn't really necessarily believe in, because when we started we did mouth pipetting and we pipetted lots of things which were quite dangerous.⁶¹ The way that you got away with it was you were very, very, careful what you did. My feeling about Health and Safety in a lot of cases, don't get me wrong, I don't think it's a bad idea, clearly it's got to be done in lots of cases, but in some ways it reduced the care that people would take. I think we were all brought up to be extremely careful what we did and latterly we relied on other people to take care of us. I'm not sure that's quite such a healthy thing.

Tansey: I was just wondering; for example, Ian, after your accident with the boxes, did you get any particular care or consideration from someone at Mill Hill?

Mathison: Yes, obviously there were other accidents and eventually the wax was removed, or rather I think it was replaced by so-called non-skid wax so there were means of reporting these accidents. There was an accident book in the medical room where Sister Jones was in charge. Normally we would report to

⁶¹ Mouth pipetting was a method of transferring liquids by sucking them directly into a glass pipette (like sucking through a straw). It was a commonly used technique in the 1960s and 1970s for most kinds of fluids, including hazardous chemicals. Accidental 'over sucking' could result in chemicals in the mouth. It is now prohibited in most modern laboratories.

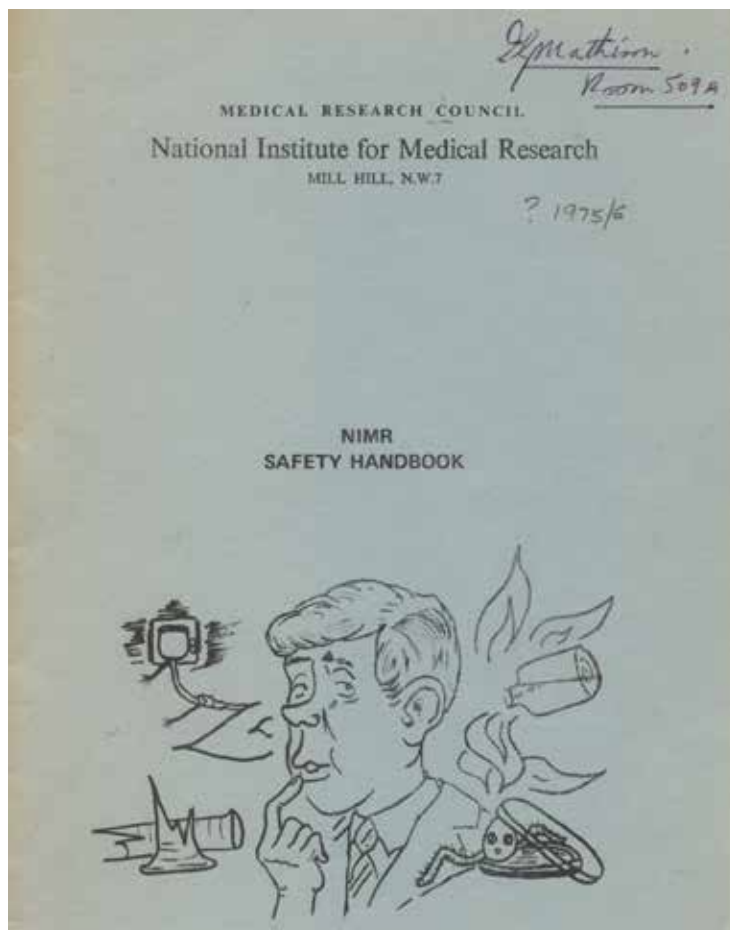

Figure 12: *The NIMR Safety Handbook, c.1975/76*

the Head Technician and I have a lot of paperwork about the development of Health and Safety at the Institute, particularly after 1974 when the Act came in, and it became very well organized.⁶² I agree with Jon's previous comments to a certain extent, and in fact when this began our own safety section in the Institute printed out some notices and they said: 'This person is responsible for your safety.' They were stuck on all the mirrors in the gents, and the ladies, toilets – I felt that was quite a good idea.

⁶² The Health and Safety at Work etc Act (HSWA) of 1974 made 'further provision for securing the health, safety and welfare of persons at work, for protecting others against risks to health or safety in connection with the activities of persons at work, for controlling the keeping and use and preventing the unlawful acquisition, possession and use of dangerous substances, and for controlling certain emissions into the atmosphere...'. See www.legislation.gov.uk/ukpga/1974/37/contents (accessed 24 March 2015).

Getting back to the wax on the benches. This was a real nuisance because of accidents involving inflammable liquids; there was one in my lab where we were doing a distillation and the rubber bung had been left in the drying tube, so you were in effect heating a sealed system, and the flask jumped down and smashed just as I was coming into the lab and the inflammable liquid set fire to the waxed bench. I think it was Harold Perkins who turned to me and said: ‘What shall we do now, Ian?’ I hit it very hard with a large cloth, which put it out. But the wax was a nuisance, it always had to be redone and polished and through the painters I found that there was a company doing an epoxy mix (you mix A and B of this varnish and then you allow it to cure). Working with Jack Prosser, who was the ‘A’ man of the painting section then, I got a sample of this paint and I asked him to coat a large square of teak board on which I had inscribed a grid pattern. I got him to put three layers on one half, and two layers on the next half, and then I divided those two halves up and added sulphuric acid and other agents, including acetone, nitric acid, and white spirit etc., and left it for 24 hours. Now this was quite successful, I think the only thing that affected this epoxy coating was glacial acetic acid and concentrated nitric. I reported back to the painter and then a high ranking rep came from the company that was selling the varnish and wanted to take my report and the test-board, but I stopped this because it was very important not to allow such results to be publicized. In other words I could imagine this going into print, this advertisement saying: ‘As tested at the National Institute for Medical Research.’ The varnish was purchased and used on the benches for a number of years. After a few years it did crack, making the benches difficult to clean; radiochemicals in particular were dangerous because they would get into the cracks and stay, depending on the half-life of the radioactive material. So then Benchkote came in and no one ever knew which way to put it up: shiny side up or absorbent side up.⁶³ There was always that controversy.

Tansey: Can I just ask you about the mechanisms within the NIMR when you’d done your experiment; how did you then get that adopted throughout the Institute?

Mathison: Are you talking about the coating on the benches?

Tansey: Yes, how did you negotiate that?

Mathison: I worked through the painters, and I remember speaking to Mr Cree who was in charge of the Works and Maintenance Department.

⁶³ Benchkote protects laboratory surfaces against hazardous spills. One side is smooth and absorbent, the other is a laminated polyethylene layer that prevents liquids draining down to the work surface.

Tansey: And then that implemented the change throughout the Institute?

Mathison: Yes.

Marsh: Wouldn't it be through the Head Technicians? Wouldn't they adopt it? You'd only go to Cree to get your bench done, but if it was going to be adopted as a general policy, which would be something that the Head Technicians would yap on about, and they'd decide that that was what was coming. That's how it worked, wasn't it?

Mathison: I assume that's what happened afterwards but I initially contacted Jack Prosser, head of the painting section, and then spoke to the Head of Works and Maintenance. I think Jon is probably right, it also went to the Head Technicians Committee. I wasn't a member of that committee at that stage.

Marsh: Actually it would have been the House Committee in earlier days. I think Rosemary's the House Committee person who knows all about that, don't you Rosemary?

de Rossi: Oh yes. It was always lavatories on the agenda for some reason or other. It covered every problem in the Institute. It did change from the House Committee; I was chairman of the Head Technicians Committee when the change over from Sir Charles Harington to Sir Peter Medawar happened. I think I only got elected because I was the only lady on it – we had to have an election as to who should be chairman, it went to a vote, and I think they thought they'd get rid of me by making me chairman. So I couldn't make so much noise on the Committee.

Tansey: Could you say a little bit more about this Committee?

de Rossi: The Head Technicians Committee used to meet about once every three months with any sort of moan or where they thought things should be changed. It was through them that we managed to finish Saturday morning working and turn it into a five-day week when Sir Peter came. Sir Charles wouldn't make the decision because he said he was leaving and he wouldn't commit Peter Medawar to the change, he thought it had to go through him. The Head Technicians Committee had quite a lot of sway in those days.

Tansey: Was this committee in existence at Hampstead?

de Rossi: No. I don't think so.

Tansey: So it was something that started at Mill Hill?

de Rossi: As far as I know it started at Mill Hill because I wasn't on it to start with; I obviously went up through the ranks. We set up, and started Immunology in about 1957. That was a new division with John Humphrey and I was made Head Technician then. Mind you, I was only paid as a junior on the pay scales but I was also a Head Technician. I said I thought I needed some more money and they said: 'Oh no, you can't, you're not old enough to go on the next scale', so that was it.

Marsh: Talking about money: the MRC were incredibly tight fisted to get any money out of but if you became a Research Officer (RO) – generally if you'd got A-levels then you became an RO – that was pretty good. I think my money went from about £280 a year to nearly £400 a year in one increment. But after that you relied on getting increments every year. This was the good thing about working for the MRC, you did get this increment every year until you got to the top of the scale and then if you'd played your cards right you'd go from Junior Technician to Technician, and then from Technician to Senior Technician, or equivalent with the ROs. We used to get paid on the ground floor. We used to get paid in dosh.

de Rossi: Yes, when we first started at Mill Hill and at Hampstead you used to have to go down on Friday mornings to get your pay and you got it in a brown envelope.

Marsh: It was the lower ground floor, wasn't it? It was Terry Jarrett and Ivy Newman who dished out the money and you'd get a brown envelope and you could see it through the little holes. Ooh, it was lovely, getting the money.

de Rossi: And then came the transition when they decided that we'd all have to have bank accounts.

Marsh: That was another thing that I think the Head Technicians negotiated, getting an agreement with Westminster Bank or whichever one it was.

de Rossi: It was NatWest. Well, it was National Westminster in those days and they suddenly said: 'Right, we shall go from weekly pay to monthly pay.' Of course, then there was a howl from everybody because they said they couldn't afford to wait for a month on a week's pay. So they did it fortnightly for three months as a transitional agreement.

Marsh: You did ask earlier on about work. We did actually do some work, though it doesn't sound as though we did.

Tansey: I'm pleased to hear it. We've not heard much about it.



Figure 13: Les Hills, Senior Technician in the Chemotherapy Division in the 1960s

Marsh: One of the things we did a lot when I was in Chemotherapy was counting down a microscope. We spent hours and hours and hours, so long we'd sometimes go to sleep – if it was a binocular microscope with a bit of luck you could actually go to sleep on it; with a monocular you would fall off, it was a bit trickier. But we used to count – in my case in Chemotherapy we worked on trypanosomiasis, malaria, schistosomiasis, and filariasis. With malaria and with trypanosomiasis you were counting blood smears, looking for the number of infected cells per 200 red cells, or certainly with trypanosomes, it was per 200 red cells, and that's what we did. We used to use these little tally counters – little grey things with a button on the top, which you pressed and it would go 'click, click, click, click, click'. This was exceedingly tedious and it took ages to count the field and then you'd move to the next field and you'd count and the next field, no wonder we went to sleep – that was one of the reasons that I moved to Electronics. Neil Brown said to Hawking: 'You know there must be a better way of doing this. Can't somebody in Electronics invent a way of doing this?' They went up to see John Lewin and John said: 'Yes, I can think of something that will probably be a big help but I haven't got time at the moment to do it.' So Neil said: 'Well Jon Marsh has got nothing to do, so you can have him for one day a week or two days a week.' And that was how I moved to Electronics.

I was going to tell you a little anecdote about the cell counting. Once a month we used to do a smear of our own blood to make sure we hadn't caught anything, which is always a bit worrying. If you had caught anything then the level of infectivity in your blood would be very small, it would be one tryp per every six or seven fields. So we thought we'd have a little joke on Les Hills, who was

one of the Head Technicians then. Bless him, Les was a lovely bloke. We got a rabbit that had very low infectivity, about the same as a human would have, and we had all our slides stained with Giemsa stain and we had our names on and we got Les' slide and we changed it for this rabbit, which was infected. Then we waited for him to start looking at it and we were all there looking and there was Les over there with his microscope. He's casually looking and all of a sudden you could see him focusing the microscope like mad, poor old Les. But we didn't keep him in agony for very long.

Wolff: A name that hasn't arisen for Hampstead is a Mrs Lang. Mrs Lang, for all intents and purposes, ran Hampstead. She was the administrator, there was no resident director, and she had one or two other people working for her. When you ask me 'what did technicians do?' one of the things they did – certainly as far as my own outfit was concerned, because we were doing large experiments in the field – was to order things. The amount of purchasing that we did was quite phenomenal. The money did not appear to be an object and the person who did it for me was called Larry Ryan, who has spent a lot of his life being my Chief Technician, and I still have lunch with him once a fortnight – he's 80, he worked for the MRC until he was well past 70. He got extremely good at this kind of thing but we had to ring up somebody at Mill Hill to get an order number because to place an order you would either have a piece of paper with a number on it or most people who knew us would allow us to order things merely by having an order number and telling them what it is, and in due course the order would catch up in the post. But certainly, for the people who were associated with me, procurement and making things was a major part of their daily life, which was standing at a lathe or winding wire around something or drilling holes into something, because most of the equipment which was used for these huge field experiments was in fact made in the Institute.

Tansey: The making of equipment is an important point, which we haven't really discussed.

Mathison: This is back to the House Committee again. As you've heard earlier, that considered everything else that wasn't covered by other committees in the Institute and was made up of hopefully a representative of all the different grades of people working in the Institute. I'm sure they were instrumental in changing the toilet paper, of which I have a sample here (Figure 14).

Tansey: I should just like to say unused sample, for the record. [Laughter]



Figure 14: Toilet paper from the NIMR (1950s)

Mathison: Oh yes, it's unused. When I joined the NIMR in 1953, this toilet paper was in general use. Each perforated sheet is marked with a triangle, and 'government property' at each end – it was replaced by more suitable, softer paper (unlabelled) some time in the mid-1960s. I'll never forget one of our many visiting workers, an American, came running out holding a sheet of this shouting down the corridor: 'What the hell is this? Why have you got "government property" written on it?' So I said: 'Well, it's to stop people from stealing it.' He said: 'Well no one in their right mind is going to steal this. It's okay for tracing paper but no good for anything else!' [Laughter]

Wolff: We had a number of rolls of it, for some reason or other, and being eBay customers and sellers we managed to sell Izal paper, which is what it is, for £13 a roll. So you should have invested.

Mathison: I have two rolls left.

Tansey: I think we should move on into the 1970s and perhaps develop some of the themes that have already been raised, such as Health and Safety, and what technicians actually did, and also the issue of equipment and what was actually made in the Institute itself. Peter Morris is going to start us off by talking about the general history of the chemical laboratory to stimulate some ideas and thoughts that we can then take up and talk about.



Figure 15: Dr Peter Morris speaking on the history of the chemical laboratory

Morris: I must emphasize that my talk is not specifically about the NIMR or indeed even about the 1970s but it's a more general talk about the history of the chemical laboratory, but I hope nonetheless that you will find it interesting. My interest is in how chemical laboratories have been changed by the demands of chemistry and at the same time how innovations in laboratory design have assisted the development of chemistry, hence my title 'Form and Function'. I'm also interested in how the leading chemists in the laboratory played a key role, firstly in the decisive element of competition between different universities to hire them, and then by their demand for a better laboratory. In actual fact the design of the laboratory remained stable for a long period of time. [A version of the lecture is reproduced in Appendix 3.]

Tansey: Thank you very much, Peter. I think your talk has stimulated questions about laboratory design, techniques, technology, equipment, and one thing that's very marked is the decline in the number of people and specialized technicians. We're now moving into the 1970s. What was happening in the 1970s at the NIMR?

Mr Peter Turner: I joined the NIMR in 1972, having worked for an MRC unit in Cambridge, and there are lots of stories that can be told. We've already spoken with Jon this morning about how we came to the Institute as an entire group with the new Director, from the previous year, Arnold Burgen, who took over



Figure 16: Mr Peter Turner

from Peter Medawar.⁶⁴ I remember slightly later in the 1970s that there was a huge change in the way laboratories were set out, particularly the teak benches, which were still in existence when we arrived. And, as Ian mentioned earlier, the Health and Safety at Work Act 1974 brought in a whole raft of changes. I can also tell you some stories about people, like Jon Marsh, who were not convinced that Health and Safety at work was needed to be taken quite so seriously, but that'll maybe come up in conversations. Certainly there was a big change towards the end of the 1970s where people in the Institute were moved around, decanted as Jon reminded me earlier, because laboratory space was being upgraded and essentially that meant taking out all the teak benches, taking out the cork floors, putting down Trespa benches and Altro Flooring – a very heavy-duty heavy-wearing thing. So I remember the late 1970s particularly as being an era where a lot of stuff changed quite dramatically in terms of laboratory design.

Tansey: Can I ask who was responsible for that laboratory design? Was this something that was imposed by the MRC? Was it something that grew up within the Institute? Were technicians consulted? The Head Technicians?

⁶⁴ Mr Peter Turner wrote: 'This may well have been "in conversation" rather than in the Seminar but it was important. Arnold's entire research group were relocated to the NIMR from Cambridge. This was not universally popular with many existing staff at the NIMR as we were seen as getting preferential treatment, funds, and facilities at the NIMR. It certainly took some while to begin to be accepted but we were a tight knit group determined to make the move a success and be a full part of the NIMR.' Email to Ms Caroline Overy, 1 July 2015. Sir Arnold Burgen (b.1922) was Director of the NIMR from 1971 until 1982 when he was appointed Master of Darwin College, Cambridge. For further biographical details see page 177.

Turner: I think probably yes. Ian will probably tell you it was led perhaps by Head Technicians and staff themselves rather than experts coming in from outside. Or do you remember differently?

Mathison: No, I need to contradict this. I'm afraid heads of divisions were asked to design their new areas and, with all due respect to heads of divisions and senior scientists, they weren't at the sharp end, as it were. I've got a good example of this when the canteen was relocated in the north building at the NIMR, we're talking now 1969/1970. The old canteen area was turned into new laboratory space to house the newly set up Divisions of Genetics and Developmental Biology, with Robin Holliday and Mike Gaze as heads of divisions, respectively.⁶⁵ Mike Gaze was from Edinburgh, and Robin Holliday was working then in Microbiology, with Howard Rogers as head of the division. I was invited to be interviewed for the position of Head Technician there of two divisions. I thought that would be quite interesting and accepted the new position.

When I got up there most of the laboratories had been set up, and, to my horror, I found that none of the sinks had overflows, and we were immediately above 4M, which is the mezzanine area and the library on the fourth floor. The inevitable happened, someone left the tap running, a sink overflowed, water ran through the cracks in the concrete floor, dripped through the large lighting systems in the library, and dripped onto the published material down there. I remember buckets being put out to catch the water, all the lights were switched off, and then we had to mop up. But there were many other aspects that appalled me. There was a light switch for the dark room on the outside so, you can see what I'm going to say, you could be working in the dark and someone would come along and turn the switch on. [Laughter] Heat and air conditioning were badly designed. I made a list of all the problems and eventually got them rectified.

Soon after the two new divisions were up and running, plans were being made to replace the Animal Division labs with new labs and a computer suite in the south-west wing, second floor. The then director, Sir Arnold Burgen, invited me to join Dr Peter Bayley and Dr Jim Feeny on the lab planning committee, and, having campaigned in the past for technical staff to be involved, I gratefully accepted.

⁶⁵ Robin Holliday (1932–2014) worked at the NIMR from 1965 and was Head of the Genetics Division from 1970 to 1988 when he moved to Australia's national science agency, CSIRO, in Melbourne. His research on methylation was central to the field of epigenetics; see Holloman (2014). The neuroscientist Michael (Mike) Gaze (1927–2012) joined the NIMR in 1970 to set up the Division of Developmental Biology. He was Deputy Director of the NIMR from 1977 to 1983 when he left to form the MRC Neural Development and Regeneration Group at Edinburgh University.

The brief was to design universal, adaptable lab space, as we were not told at this stage who the occupants would be – looking back I think we got most of it right! After a number of meetings, project costs were presented to the full planning committee and were unsurprisingly over budget. The MRC representative Mr Cox stated that at this stage the three-man planning committee normally leaves the main committee and that cost cutting meetings should follow. I formally objected, and stated that we were best placed to discuss the changes to be made – after some discussion a compromise was reached and one of the three was allowed to remain on the main committee.

Tansey: And was that model followed afterwards?

Mathison: A lot of it was. Due to the way the services ran and island benches were unsatisfactory because you didn't want services coming up through the centre of the floor as they were in the Institute when I first joined. That was quite dangerous. You had to lift out a square foot section of floor panel in order to plug in the cables, and there was an interesting incident involving Howard Rogers – this is now going back to the 1950s. I was running an experiment involving Warburg manometry, the mains cable supplying power for the water bath with its stirrer and shaker motor heaters was plugged into the 15-amp socket directly under Howard Rogers' chair where he was writing up his notes. The displaced section of the floor panel was close to the wire, my warning of potential danger was ignored, and some minutes later there was a very loud bang and a cloud of bluish smoke. Dr Rogers nearly bit through the stem of his pipe and the experiment was ruined. The incident cut off power to all the labs in the north-east wing first floor, and everything went quiet! Anyway, island benches were replaced by peninsula benches and we had to be very careful too about the drainage runs where they went down into catch pots. Someone once poured ether into their drain at one end of the lab, the ether ran along towards the catch pot, and someone was using a Bunsen burner at the other end of the lab, and it all caught fire, so there was a nice run of flames along the drain pipe. Having had these experiences I was in a position to improve future design. In the 1970s, lab space was now being set up with 8 ft × 8 ft and 16 ft × 8 ft modules. The ideal one was 16 ft × 8 ft with an adjoining office on the window side: isolation of the office maintained a clean area away from the laboratory, but close enough so you knew what was going on. Generally speaking, these layouts became the norm. Also the coatings of benches were improved and many more electric outlets were added, replacing a lot of gas outlets, which were numerous when I started in 1953.



Figure 17: Professor Ian Sutherland

Professor Ian Sutherland: You were talking more about laboratories then. I'd like to talk about some of the projects that I was involved with and also the importance of having a skilled instrument lab to make equipment for research and research experiments.

I arrived at the National Institute for Medical Research in a very unusual way, and, like Heinz, if you don't mind, I'll just tell a little story because it's a very unusual way of getting the job because I was actually working for NASA in the United States. When I knew my time there was coming to an end, I was working on the machining of space-age alloys and not related to medical research at all, I wrote to my Bristol supervisor where I did my PhD to say that I was looking for a job in mechanical engineering – did he have any ideas? At that time someone by the name of Denis Rothwell, who was head of the Engineering Department at the National Institute for Medical Research, wrote to the same person to say that he was looking for a mechanical engineer – did he have any ideas?⁶⁶ And, of course, Colin Andrew, who was my supervisor at Bristol, said he just put both letters in opposite envelopes and sent them off to each of us and we got in contact. But what was fascinating was that Denis Rothwell arranged to have a visit to NASA to interview me. When I was there I suddenly got contacted by the Foreign Office to say: 'Ooh, the Medical Research Council are arranging a

⁶⁶ Denis Rothwell was head of the Department of Engineering at the NIMR from 1970 until his retirement in 1988.

special VIP to come to visit NASA' and then they rolled out all of their VIPs to entertain him and to show him around and so on. And everyone was saying: 'Well, who is this chap?' But in the end I remember taking him out water skiing and we were in the middle of having fun when suddenly he started asking me a few questions and I realised I was being interviewed. Anyway I got the job, joined the NIMR in 1973, and was being asked to work on a new form of chromatography. It was called liquid-liquid chromatography. It had a name called countercurrent chromatography. It was developed by a chap called Dr Ito at the National Institutes of Health and, before I left the United States, I went to visit him in 1972 to find out what he had been doing.⁶⁷ Meanwhile, and I'm sure Jon Marsh will expand on this story, there was a gentleman called John Sharp who worked at the National Institute for Medical Research in the Engineering Department who had designed one of these centrifuges called a coiled planet centrifuge. It tumbled around as it rotated and lots of pieces of tubing were wound in loops and basically you could retain, from a two-phase liquid system like an oil and water, one of the phases stationary while the other liquid phase was passed through it. So you could do liquid-liquid chromatography. Well, as you know, the National Institute for Medical Research has a long history in chromatography because Martin and James were there just after the war and developed chromatography systems at that time.⁶⁸ I don't know the history of how John Sharp was asked to look into liquid-liquid chromatography but all I know is that my first job when I arrived was to investigate this.

I want to mention the engineering laboratories there because the fact that they could build such equipment meant that we could do quite pioneering work, in other words develop centrifuges that hadn't been developed before. This particular first one was remarkable because one thing about a coiled planet centrifuge is that as it rotates it's got a natural out-of-balance, and John Sharp had this idea that if you put a circumferential track on the top with ball bearings in and put it on a soft rubber mounting at the bottom, when this thing gained speed it would go sort of 'whoom, whoom' like this, and, all of a sudden, magically, all those balls would redistribute and then the whole thing would balance and it would run beautifully.

⁶⁷ Ito and Bowman (1970).

⁶⁸ Archer Martin and Anthony (Tony) James had developed the gas-liquid chromatograph for separating organic chemicals in 1950, and Martin and Richard Synge were jointly awarded the 1952 Nobel Prize in Chemistry for 'their invention of partition chromatography' (www.nobelprize.org/nobel_prizes/chemistry/laureates/1952/ (accessed 10 December 2015)). See also the discussion by Dr Anthony Travis in Appendix 6.

So we did some pioneering experiments with that device and that included working with the NIMR at Hampstead at the time, because Biological Standards were at Hampstead. There was a gentleman there called Jim Lightbown who had a technician, Penny Newland, who wanted to establish the World Health Organization's standard for a series of polyene macrolide antibiotics: candicidin, trichomycin, and such like.⁶⁹ One of the problems of these antibiotics was that they were surface active and so Jim couldn't use standard solid phase chromatography to separate these compounds and so this liquid-liquid process was tried and was quite successful. Using this technique he was able to get the first standard for polyene macrolide antibiotics and it was eventually published by the World Health Organization.⁷⁰ It was that publication that was read by the Chinese, who then set up to use countercurrent chromatography as a consequence. So the process has now become quite popular in China for the fractionation and purification of natural products that are surface active – a lot of their compounds are surface active. I could go on at length to show how the technology has advanced but all I will say is that Jim Lightbown wanted us to build a large instrument for fractionating preparative compounds – in other words large amounts for doing the standards work – and in the instrument lab at Mill Hill we made this 6 ft-diameter instrument with these rotating coils, which was installed in his own purpose-built laboratory at Hampstead. Rosemary, I think your husband, Peter de Rossi, was the chief technician for Jim Lightbown at that time because I remember getting a lot of help from Peter in designing the thing, making it safe.⁷¹

The other thing I wanted to mention was the Health and Safety issues, because at the time we were using solvents like chloroform, methanol, and water, with borate buffer in them to sort of standardize the pH, but literally we had no air extracts or anything like that. I remember really enjoying the smell of chloroform [laughter] but I've now since found it's carcinogenic – has that affected my

⁶⁹ James Lightbown (1918–2013) worked at the NIMR from 1949 and was responsible for antibiotic standards and was involved in international standardization until his retirement in 1983; see Anon. (2013/2014). For the biological standardization of antibiotics and Lightbown's contribution, see Bangham (1999), pages 88–106.

⁷⁰ Lightbown *et al.* (1977).

⁷¹ Mr Jon Marsh wrote: 'Peter was married to Rosemary. They both worked at Hampstead NIMR, Rosemary came to Mill Hill in 1950, Peter worked in Standards at Hampstead, then to Clare Hall. He was an active member of NIMROD, very into sport and sailing.' Email to Ms Caroline Overy, 26 July 2015. Mrs Rosemary de Rossi added: 'He moved to Mill Hill then returned to Hampstead a few years later, when part of Biological Standards Division returned to Hampstead.' Note on draft transcript, 27 January 2016.

later health problems? I don't know. But one thing I did want to mention on Health and Safety was that I can remember in those days being allowed to work through the night, because sometimes those experiments would take a long time. I was the only person in Holly Hill – there wasn't even a security man – working on my own in the lab when I had a pi pump⁷² and was putting the pipette in the end, it slipped and broke and it went straight into my hand. Blood started pouring out onto the floor and I thought, 'Oh my goodness', so I quickly wrapped my hand in a sort of towel and went down to A&E.⁷³ But what I hadn't thought about was leaving a note or anything, and apparently when people came in in the morning there was this pool of blood on the floor and no sign of anybody anywhere. Everyone set up a search to see if I'd died somewhere in the cellar or something like that. So I know at that time – this was the mid-1970s – that there were no safety regulations to cover things like that. All they knew was that I had to obviously sign a book that I was working late, that it was me. So there was a search out for me to try and find me.

Travis: Ian, can I ask a question, please? I'm very interested in the countercurrent chromatography device. Two questions: I've a note that in mechanical engineering there was yourself and a Dr Sharp?⁷⁴

Sutherland: Correct.

Travis: Second, did you jointly invent this device, or was it Dr Sharp's, or was it yours?

Sutherland: Countercurrent chromatography was invented by Dr Ito in the National Institutes of Health in Bethesda in Maryland.⁷⁵ John Sharp, I believe, designed a coil planet centrifuge, which was a unique design, and I think that was his design. Subsequently, after John left, I designed other versions, a larger-

⁷² A small device used with a pipette inserted at the end to draw up and release liquids with one hand; this technique superseded mouth pipetting.

⁷³ At the Royal Free Hospital, Hampstead.

⁷⁴ Mr Jon Marsh wrote: 'John Sharp was a mechanical engineer and member of the scientific staff in the Department of Engineering at the NIMR. He produced many novel designs in connection with the scientific research at Mill Hill, including a countercurrent chromatography system and a spectrofluoropolarimeter. Email to Ms Caroline Overy, 23 October 2015.'

⁷⁵ Ito *et al.* (1966). Dr Peter Morris wrote '... the history of countercurrent methods generally goes back further and is more complex than this remark might suggest. Archer Martin was working on countercurrent methods in the late 1930s before he switched to partition chromatography and Lyman Craig developed countercurrent distribution in the 1940s.' Email to Ms Caroline Overy, 22 July 2015.

scale version, of an I-type centrifuge and also a toroidal coil centrifuge was made because I went on to study methods of separating cells and macro-molecules. A lady came to work with me called Debbie Heywood-Waddington, and she was a biochemist and was working on the purification of organelles and macro-molecules using aqueous two-phase liquids.⁷⁶ These were polymer phases where you have something like a PEG, a polyethylene glycol phase, and a dextran phase which, when you shake them, they take a long time to settle but they do separate out into two liquids. We worked with those for a number of years. So we had a number of patents along the way of different equipment that was all made in the workshops at Mill Hill.

Travis: Was any of this done at Hampstead?

Sutherland: No, this was done in Mill Hill.

Travis: Okay, thank you. It's really important information. Again, I think it's an extremely interesting innovation, including the scale-up. Have you published anything on this, its history for example?

Sutherland: Not so much the history but what I would like to do is to invite you to come and visit us at Brunel because, when I joined Heinz at Brunel, one of the things that excited me about what Heinz did was he was working with the European Space Agency and space work.⁷⁷ As I'd had a background in space work⁷⁸ he asked me to look after his space programme for 10 years. But as this work progressed to the flight hardware stage our R&D involvement diminished and ceased altogether a few years later following the Columbia disaster.⁷⁹ We had a little bit of a problem because the money wasn't coming in, so I had to turn my hand to something else. At the same time someone came from the States saying: 'We want to make a countercurrent machine. We are worried that

⁷⁶ See, for example, Heywood-Waddington *et al.* (1984); Heywood-Waddington, Peters, and Sutherland (1986).

⁷⁷ Between 1971 and 1992 Professor Heinz Wolff was an honorary member of the European Space Agency and later chairman of several advisory committees at the European Space Agency, including the advisory committee looking at the uses of the low gravity environment for scientific research. He was also scientific director of Project Juno, which sent Britain's first astronaut, Helen Sharman, to the Mir space station in 1991.

⁷⁸ See page 40.

⁷⁹ In February 2003, the space shuttle Columbia disintegrated when it re-entered the Earth's atmosphere over Texas, killing all seven crew members.

it won't pass the Health and Safety in the UK. Can you build us one which is safe but also it's got this bobbin on one side that goes around like this; why can't we have one on the other side?'

Well, one thing we haven't mentioned is that this device has an anti-twist mechanism. There are leads that come down and go around and up like this, and they travel around it and untwist as they go like magic. It's as if you don't need rotating seals, you can pass the liquid into these rotating columns magically. We built this and eventually one of my designers, it was an ex-employee of yours, Heinz, David Hawes, managed to design two of these, one upside down relative to the other, that played follow my leader. So we developed a new countercurrent device once I got to Brunel. We then worked on the scale-up of this process and we have now built instruments that are the size of a 2m cube housed in a Hazard's Lab the size of this seminar room, which can manufacture kilogram quantities a day of pure drug. It is now becoming a technology that is just finding its place in industry.⁸⁰ It is at the analytical and at the preparative scale but the full production scale is only just beginning to take place and there are places in China that are beginning to use it as a production process because it doesn't cost much to run because there are just solvents that it uses – solvents and water. There are no expensive columns and you don't lose any sample. You always get the sample back because the stationary phase is liquid so you can always pump it out. It's quite a fascinating technology and we've got the eighth International Conference on the technology coming up next month at Brunel. We founded the first one in the year 2000 and we've got the eighth one coming up in 2014.⁸¹

You are welcome to come and have a look at the technology but it all started at the NIMR in terms of doing the engineering on it because the original inventor in America was a medic and the instruments he made always fell apart. It was when we started putting engineering into making these instruments that they became reliable. Because actually, when you think about it, rotating things in planetary motion have a lot of out-of-balance forces and getting that to work reliably is quite a difficult job.

⁸⁰ For a demonstration of this technology by Professor Ian Sutherland and for its commercial applications and use in drug development see <https://vimeo.com/143812822> (accessed 7 December 2015).

⁸¹ The first International Conference on Countercurrent Chromatography was held in London in September 2000; see Berthod and Sutherland (2001). For the Eighth International Conference, see Ignatova and Sutherland (2015).

Marsh: Just briefly to add a bit about John Sharp; he has also another interest in common with you, Tony, and me – this is a little bit of anecdote, nothing to do with any of this. I met Tony on Battersea Park railway station back in 1965 or 1966 when we were filming the Flying Scotsman coming out of Victoria and we've been friends ever since. But John Sharp is also a top steam man. He's been out to South Africa, he's been out to China to advise them on steam locomotive work and he's also been to see Porta, the chap in South America.⁸² So he's a red hot steam man and he's well known in steam circles – he's a top engineer.

I just want to talk about the aspect of the Engineering Department and the facility that it was. I can't remember if it was before I took over from Denis or afterwards, but quite a number of visiting scientists, particularly from America, said to me that one of the reasons they decided to work at the Institute was because the engineering facilities, the electronics and mechanics, were second to none. They could get things done in the Institute on tap that they couldn't get done over there but they had to go outside and it wasn't right, they couldn't develop things. If the people were doing it on site downstairs, they would work with them and develop all sorts of instruments that they couldn't do anywhere else. It was terrific from that point of view. I hope they haven't forgotten that at the Crick. We'll have to have a word with Sir Paul Nurse.⁸³

Dr Andrew Pinder: I want to talk about the instrumentation in a second but, just before I do that, Ian said about how he started at the Institute. When I was interviewed I'd actually just got out of hospital. I'd been hit on the head in a sailing accident with a boom and was suffering from concussion, and I was interviewed by Denis Rothwell. I sometimes wonder what would have happened if I hadn't been suffering from concussion. [Laughter] As part of that interview he then said: 'Well, a formal thing, you'd better go and see Arnold Burgen. Do you know anything about nuclear magnetic resonance (NMR)?'⁸⁴ And I said: 'No, not really.' Well, fortunately NMR didn't come up in the conversation. I think it was about six to eight weeks, something like that, after the interview that I actually started and unusually I didn't have my push bike on the first day and I was walking up Bittacy Hill in absolutely teeming rain and a car stopped

⁸² Livio Dante Porta (1922–2003) was an Argentinian steam locomotive engineer.

⁸³ On 15 April 2015 the NIMR closed at Mill Hill and became part of the Francis Crick Institute, the new biomedical research institute in central London, www.crick.ac.uk/. Sir Paul Nurse (b.1949) is Director of the Francis Crick and was President of the Royal Society until November 2015.

⁸⁴ The Biomedical NMR Centre was established at Mill Hill in 1979. See their website at <http://mrc-nmrcentre.crick.ac.uk/> (visited 21 December 2015).



Figure 18: Dr Andrew Pinder

and said: ‘Would you like a lift?’ and it was Arnold Burgen. The point I want to make is what a change from the days of Harington where one would actually have had to get out of the car, not get in it. [Laughter] Also I was impressed by the fact that he actually remembered my face from eight weeks previously. That was the only time I ever got a lift from him.

| | |
|-----------------------|-----------|
| Sir Henry Dale | 1928–1942 |
| Sir Charles Harington | 1942–1962 |
| Sir Peter Medawar | 1962–1971 |
| Sir Arnold Burgen | 1971–1982 |
| Sir Dai Rees | 1982–1987 |
| Sir John Skehel | 1987–2006 |
| Sir Keith Peters | 2006–2009 |
| Dr Jim Smith | 2009–2015 |

Table 2: The Directors of the NIMR

Coming on to the instrumentation, nowadays one takes it for granted that you more or less buy whatever it is you want and adapt it maybe – essentially you can buy it. Before that one would buy a computer in the electronics field and maybe make some interface for that, but in the 1970s you couldn’t even really buy a computer – we were building our own computers. So we had a small custom-built processor board, basically that was NIMR design and you would then write everything from scratch. You would literally build it from scratch. Even down to writing graphics routines and all the other things that one takes completely for

granted nowadays. If the research budget ran to it, I suppose towards the end of the 1970s, the DEC LSI-11 started coming in, which was basically a miniaturized version of the PDP-11 in an enormous box.⁸⁵ The box was actually 90 per cent air, so why they put them in these enormous boxes I don't know. But even then you were buying the hardware, you weren't buying the software. Okay, it came with an operating system but after that you were on your own. A lot of work went on in writing, developing quite sophisticated stuff. John Green, for example in computing, basically wrote an editor.⁸⁶ There were no decent editors. You couldn't actually write the code because there wasn't an editor and one day John just sat down and wrote one. That was the way it was, you did it all yourself.

Morris: That raises an interesting question because some scientists like to claim that they had to build all their own equipment and that's why it works and so on. A question I've got particularly for this audience is how far was this equipment actually built by the scientist or how far was it actually built by their technician for them?⁸⁷

Marsh: I think that depends on the scientist. You had people like Martin Wright, who would build all his own stuff, and other people wouldn't have the faintest idea.⁸⁸ When I went to work in Electronics I'd been at the NIMR for five years, I had eventually got these qualifications at Brunel, I did go back and do another load of years and got all the exams and heaven knows what, and that was one

⁸⁵ Dr Andrew Pinder wrote: 'The PDP-11 was a series of 16-bit minicomputers sold by Digital Equipment Corporation (DEC) from 1970 into the 1990s. In total, around 600,000 PDP-11s were made, making it one of DEC's most successful product lines, and considered by some experts to be the most popular minicomputer ever. The PDP-11 had several unique and innovative features, which influenced the design of most late-1970s processors, including the Intel x86 (as used in the first-generation IBM PC) and the Motorola 68000 (as used in the Apple Mac). ... The LSI-11 (aka PDP-11/03), introduced in February 1975, was the first PDP-11 model produced using large-scale integration.... These computers eventually fell into decline, being superseded by DEC's own VAX superminicomputer, and personal computers from IBM and Apple, all of which had faster bus structures and 32-bit addressing. Taken from: <https://en.wikipedia.org/wiki/PDP-11>.' Email to Ms Caroline Overy, 1 July 2015; website accessed 10 December 2015. For further information on computers at the NIMR, see Appendix 4.

⁸⁶ John Green worked in the Computer Science Laboratory of the Engineering Department from 1974.

⁸⁷ For an example of scientists and technicians building their own equipment see Tansey E M (Tilli) 'Building Henrietta: DIY electrophysiology in the 1950s' online at www.histmodbiomed.org/blog/building-henrietta-diy-electrophysiology-1950s (accessed 20 May 2015).

⁸⁸ Martin Wright (1912–2001) worked in the Instruments Division at the NIMR from 1957 until 1969 when he moved to the Division of Biomedical Engineering at the Clinical Research Centre at Northwick Park. See [Wolff] (2001); Wright (2001); see also the comments on page 51.

of the reasons Jack Perkins, who was in charge of Electronics, thought it might be a good idea – he thought I could know a bit about biology and a bit about electronics as well, and that might be quite useful. I don't know whether it was useful or not but I think the idea was that if you knew a bit about the biology you could go and talk to the biologists and you could discover what it was they really wanted. Quite often, some of them had really good ideas, but some hadn't got a clue about the engineering aspects and what transducers would be needed to get the signals from whatever they were doing into some form where you could manipulate it electrically or electronically, and then later on with computers. So it depends on the scientist. Some of them would be heavily involved, very clever, and some of them had no idea about that aspect. They were trained in biology.

Mathison: This is an example of a collaboration between Ian Sutherland and myself. The electrophoresis situation was getting a bit complicated in the Institute – we're now talking about 1974 to 1976. There were many home-made pieces of apparatus, all different designs, and Raven Scientific was one of the companies making these pieces of equipment. Very often small companies working from a sort of garage in the back and some of the bigger companies were interested in developing equipment. So Ian and I worked together and did a survey, through the Institute, of people's requirements and what sort of apparatus they had and what they were capable of. I've got the paperwork here. Eventually we set up an electrophoresis open day and I've got the photographs here of the Institute's electrophoresis demonstration.



Figure 19: Demonstration of electrophoresis apparatus at the NIMR, 25 October 1974

We were able to get all the users together in the Institute and I think it worked because we had a good consensus of opinions about the best design. That eventually led to the Engineering Department being able to get on with other work and some of the companies taking up our suggestions and going into production. Later we were able to buy the commercially made pieces of equipment, which were designed to our requirements. Was that about right, Ian?

Sutherland: Yes.

Marsh: I'd like to say something about electrophoresis power supplies. Back to the 1960s to start with, when I went to work with John [Lewin], we had to make a lot of very high-voltage electrophoresis power supplies, thousands of volts. They were bloody dangerous. They used valves because you couldn't use transistors in those days to get that sort of voltage or anything. But that's beside the point. The point was these electrophoresis power supplies were very dodgy things and we developed a system of earth leakage protection for high-voltage electrophoresis power supplies, which meant that if you did accidentally touch one of the terminals then you weren't going to get bumped off. This was something that was taken up by industry everywhere and a lot of the original commercial electrophoresis power supplies were ones that we built, which the MBI supplied a lot of, and we designed those up on the sixth floor. So that was another thing where we did it first. Good stuff.

Tansey: Can I ask a bit more about these commercial links. You've talked before about the MBI:⁸⁹ was that unusual? Was that unique? Were a lot of you consulting with companies?

Marsh: No. What happened with MBI was that one of the people who ran it was an ex-electronics person from our department and he cleared off from the MRC because he couldn't afford to live on the salary any more, and he set up his own company. They then thought: 'There's some good stuff at Mill Hill, we'll market it.' How that worked in terms of patents and payments I've no idea. I think in those days it didn't work at all, they just took the ideas and they built them and the MRC got nothing out of it. Of course, it's all changed now, but it was altruistic in those days, we did things, and if they were a good idea we gave them away.

Turner: I support what Jon said. There was a lot of technology and the idea of technology transfer and everything else really didn't come into it so lots of good

⁸⁹ See pages 22–3.

ideas went away, and the MRC nationally are very famously known for giving away a lot of their early technologies like monoclonal antibodies and the like.

Tansey: I think until monoclonal antibodies the MRC hadn't really thought about it.⁹⁰

Turner: No, and that was the one that became the focal point that turned the corner. But in those days, I think Jon's absolutely right, you liaised with these people purely on a friendly basis and if they took the ideas and developed them, good for them.

Sutherland: I don't quite know when the appropriate time would be to bring in the pump story because as you know you mentioned Martin Wright but there was a thing known as the Mill Hill Infuser, which was used for insulin infusion in the days when insulin came in 40 units per ml.⁹¹ Heinz, I don't know if you remember when Martin first designed the Mill Hill Infuser, do you?

Wolff: I have a curious relationship with Martin Wright. When I was very young I worked for him at the PRU because he was also in charge of a different set of markers at the PRU. Towards the end of his career he worked for me; he became part of my division. I wrote his obituary for *The Times*⁹² and a few days ago his son came to see me with a very interesting question, which I think affects all of us. He said: 'How was it that in the days when you and Martin Wright were working for the MRC, you could do more or less what you wanted to do?' He's an academic in Cambridge, and he simply couldn't understand how, without grant applications and peer review, that sort of thing, we could just go and do things. That I think distinguished the MRC from even the other research councils that followed it, and made it successful.

Sutherland: That is a very good point and one I think about a lot now because often when you're putting in a grant proposal only one in six are successful, which means that five-sixths of your time you're spending a lot of effort in actually doing nothing because it doesn't come to anything. So more hands-on science was possible by the type of system we had within the MRC and it did work very well. I felt my time there was much more productive than it is now at Brunel University.

⁹⁰ See the Witness Seminar held in 1993: 'Technology Transfer in Britain: The case of monoclonal antibodies' (Tansey *et al.* (eds) (1997).

⁹¹ See pages 52–7 for the infuser.

⁹² See note 88.

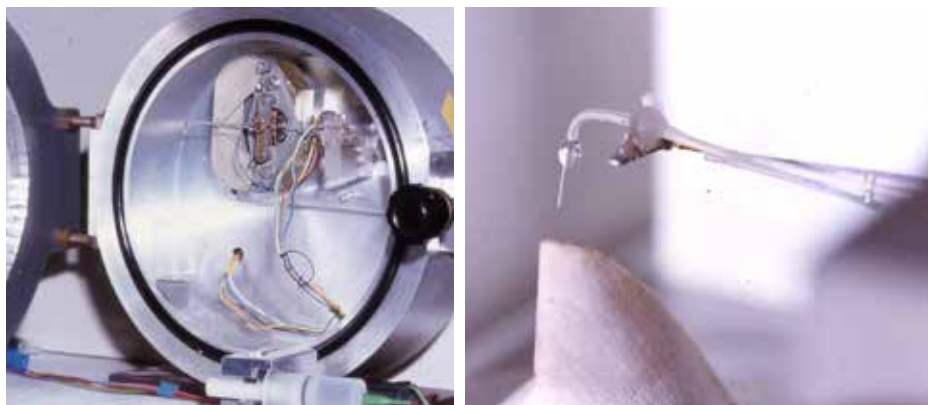

Figure 20: A galvanometer balance in a small environmentally controlled chamber (left) used to weigh small droplets infused from test infusers (right). Photographs supplied by Professor Ian Sutherland and reproduced with permission of the Institution of Mechanical Engineers

Tansey: We've had that comment come up at previous meetings and two people have made exactly the same point very, very strongly – one was Max Perutz and the other was Jim Lovelock.⁹³

Sutherland: Going back to the pump story, Martin Wright had this Mill Hill Infuser where you put a standard syringe, a 5ml syringe I think it was, into a carriage that was driven along by a screw thread. There was a call for proposals from the National Institutes of Health in America.⁹⁴ Now, unusually, because you know all research was funded by the MRC at Mill Hill, John Parsons from Endocrinology wanted to go for this, he thought it would be a very good thing to do. He got together with the diabetes group at Guy's Hospital – Harry Keene was the consultant there, and John Pickup – and together with Engineering we actually put in a proposal to develop this seven-day infuser. The whole idea of this infuser was that it had to use 100 units insulin per ml. So we applied for this grant, it was successful but then there was an uproar in the United States

⁹³ Max Perutz (1914–2002), who was jointly awarded the Nobel Prize in Chemistry in 1962, was an invited speaker at a Summer School on the History of Haemoglobin, held by the History of Twentieth Century Group in July 1993. The proceedings have not been published. For his views on science and scientists see Perutz (1989). Professor James Lovelock worked at the NIMR from 1941 to 1964. He was a participant at the Witness Seminar on the MRC Common Cold Unit held in 1997: Tansey, Christie, and Reynolds (eds) (1998); see the comments on Lovelock on page 68 and the paper by Dr Anthony Travis in Appendix 6.

⁹⁴ Professor Ian Sutherland wrote: 'The grant was "Devices for Improved Management of Diabetes", NIH Grant N/1-AM-2200 – 1978/1982, but the award was held up for a year so I imagine the original call must have been in 1976.' Email to Ms Caroline Overy, 13 November 2015.

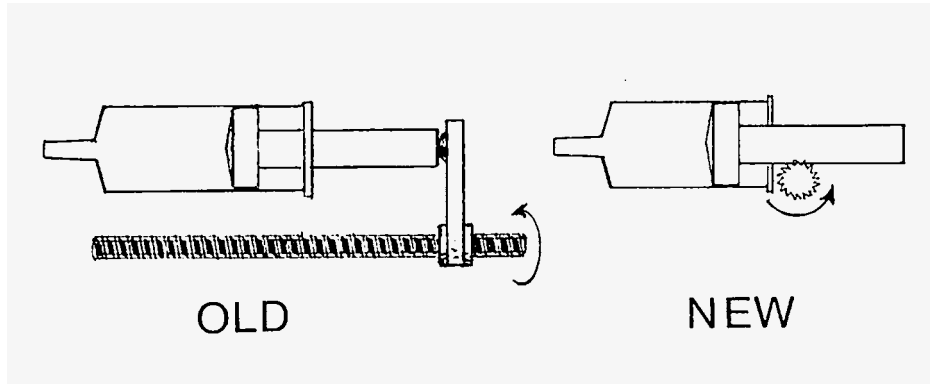

Figure 21: The old lead screw drive and the new spline drive. Diagram supplied by Professor Ian Sutherland and reproduced with permission of the Institution of Mechanical Engineers

because industry there lobbied government to say that they did not want this work going outside the United States. So eventually it was delayed for a year before we actually got the grant but we had this three-year grant to develop this seven-day infuser.

I remember it was in Mechanical Engineering that we started to see if it was feasible to actually flow 100 units per ml insulin in one of Martin's syringe pumps. So we put it in and we had to work out how to measure very small quantities of this because obviously you had to flow a lot slower, and it was Frank Doré who came up with this idea of utilizing a galvanometer balance where a very thin tube went along the arm and we weighed the droplets being formed on this galvanometer balance. Then they dropped off and we had this triangular wave form which we could then integrate and then find out what the flow was. But what startled all of us was that we found that this insulin infuser was giving a very sinusoidal wave form, in other words, it was going very high flow, then it was going very low flow, and then very high flow. It was the actual drunken thread that was causing this effect. So you talked about problems in science, this was a real problem because we realised that we couldn't use a syringe driver to deliver this 100 units insulin. So we had brain storming sessions. Geof, I don't know if you were working with us at that time but ultimately a spline drive was designed, it certainly wasn't my idea, I think it was Frank Doré and Geof working together who came up with this spline drive, which is loaded in such a way that you push the plunger of the syringe into the spline and then the spline directly drives the syringe plunger to deliver the insulin.



Figure 22: Mr Geof Chambers

We found with the syringe driver, it took ages to take up the slack in the syringe when you first put it in, but the advantage of the spline drive was that it delivered immediately, and we were able to deliver a very fine flow using that process. There are others in the team here who might like to talk a bit about the development there because it was a huge development – it was a whole development on the electronic side. Having such concentrated insulin if anything went wrong and you delivered the whole amount you could kill someone. So, on the electronics side I'll let Jon's group take over the story from there.

Marsh: The advantage of this is we've got both people involved in it. We've got Geof who did the mechanics and we've got Steve who did the electronics.

Mr Steven White: Well, I think we could probably start with Geof because I really want to go into the 1980s, 1980 to 1985. Geof did invent a method of measuring this flow, which has not been mentioned yet, which used a chemical balance arm with a pipe running along the arm. Geof can carry on.

Mr Geof Chambers: I'm not sure if I did invent that. I did the subsequent system, which was using a servo-controlled balance with a silicon fluid and collecting the liquid under the silicon fluid. So that was more of a continuous

method. I think Frank Doré was really the genius behind both the spline drive, which was this ultra-accurate method of delivering the insulin, and that original galvo balance.⁹⁵ I think that was Frank. Maybe it was me.

White: The main technical challenge was measuring the flow. You had the spline invention but how did you measure the flow? The flow was so tiny.

Chambers: Exactly that. One of the aspects of that proposal was that we'd include a flow measurement device actually in the pump itself, and Frank came up with this wonderful idea of having two sort of micro platinum electrodes actually in the flow system and we could then measure, using electronics etc., the liquid flow past these electrodes. But we discovered – I think I'm correct in this – that the electrodes themselves actually destroyed the insulin so there was a fundamental flaw there in the design. But it was really clever and really neat in the sense that we could actually measure the flow, but unfortunately what came out the other end was of no use at all. Again a really clever bit of work by Frank in terms of dreaming up this method of instantaneous flow. Just going back a bit, prior to receiving the NIH grant, I remember working with Dr Parsons and it's an example of how we could just do things in those days. I remember he wanted to convert this early Mill Hill Infuser into a pump that contained three syringes. I can't remember what was in the three syringes but basically in the workshops we converted one of these pumps and took out the 5ml syringe and cut down 1ml syringes and put them in a sort of bank, and basically the system was just taken and used straight out of the box without any sort of approvals or paperwork or instructions or anything.⁹⁶ But that was really the sort of pioneering spirit that we had at the time. I can't exactly remember what it was for. Then from there we got the NIH grant and

⁹⁵ Mr Geof Chambers wrote: 'Frank Doré was Head Technician of the Mechanical Engineering group at the NIMR. He retired in September 1981. He was a true inventor and also a very skilled machinist. Frank worked alongside many scientists throughout his time at the NIMR including Dr Martin Wright, who developed the Peak Flow Meter for asthmatics, which latterly became the breathalyser. Also Frank worked with Dr John Parsons during the creation of the Mill Hill Infuser (-1970s) and Professor Ian Sutherland during the creation of the NIH infuser which went on to be the Nordisk Infuser. It was Frank's skill as an engineer and his never-ending drive that turned ideas into workable devices. Often he was way ahead of his time – during the 1960s he developed an implantable insulin infuser which was powered by Freon gas. Insulin was to be delivered slowly to the body via a long capillary tube which ensured very precise and very slow flow. Although not a success at the time, the device reappeared in the late 1980s in the US as a method of delivering morphine to patients.' Email to Ms Caroline Overy, 30 November 2015.

⁹⁶ Rothwell *et al.* (1983).

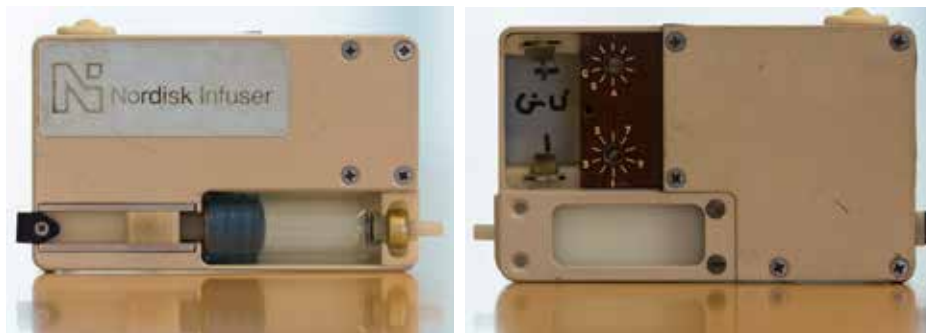

Figure 23: The Nordisk Infuser

I think Steve went over to the electronics side because one of the challenges was getting the amount of electronics into the small box because obviously we had the mechanical side, getting the motor in and the tiny gear boxes and the massive gear ratios that we had, and the driver and the special syringes. Then again there's a big story around that that I think Ian can recount later on with the siliconization of the syringes.

Sutherland: Just to put that into context, the Mill Hill Infuser was about as large as a small wallet but we were charged with trying to make it the size of a cigarette packet. So everything had to become much smaller, and I do remember the electronics, when it was first breadboarded, was about 15 in. square by 3 in. high, which ultimately ended up the size of a small chip.

This is the Mill Hill Infuser in its final size like a cigarette packet (Figure 23).⁹⁷ You see the spline drive and also this specially made container. The syringe itself is a specially made pre-filled syringe with a siliconized plunger and once we've talked about the electronics I will give you an anecdote about the plunger – when we were very near commercial production.⁹⁸ But, let me tell you the end game: the end game was that Novo Nordisk eventually took this up commercially. It was patented and Novo Nordisk did take up the patent and made 4 million of them. So it was a commercial success and it was one where the MRC got quite a lot of income coming back into its coffers.

Tansey: And what date was this, Ian?

Sutherland: That was the early 1980s that it started to become commercialized but the work started around about 1978 – the first paper was published in

⁹⁷ Rothwell, Sutherland, and Parsons (1981).

⁹⁸ See page 86–7.



Figure 24: The Mill Hill Infuser breadboard

1981 following three years of research.⁹⁹ The electronics story is an amazing one because the breadboard was about ten times as large as that device and then it got miniaturized.

Marsh: We've still got the breadboard, haven't we John?¹⁰⁰ And we took it to Hirst Research Centre, the GEC people, and said: 'We want that made into something like that' [about 3 in. × 2 in.] and they did it, didn't they?

White: Yes. It comes into my story when I joined in 1980. I should preamble, because I was out of college in 1978, I think, and went straight from college to EMI Systems and Weapons Division, signed the Official Secrets Act, and was working on secret projects, sonar buoys for detecting submarines, things that were thrown out of Nimrod aircraft, security devices for border control. It was there in that lab that I designed my first chip, and that experience was useful at the NIMR for the insulin pump, and this leads back to computers, because this is a transitional time, 1980, and in the lab at EMI we didn't have any personal computers apart from punch cards and Fortran connected to a mainframe computer.¹⁰¹ So everything in

⁹⁹ Rothwell *et al.* (1983).

¹⁰⁰ Mr Jon Marsh wrote: 'We do have this stuff, the original breadboard and the integrated circuit chip that GEC made for us, they are both at Mill Hill.' Email to Ms Caroline Overy, 26 July 2015.

¹⁰¹ Fortran (FORmula TRANslation) programming language was originally developed by IBM in the 1950s with programmes written and stored on punch cards.



Figure 25: Mr Steven White

that lab was discrete digital logic and we didn't have microprocessors – they did exist but they were just coming into production really at that time. Then we had this transition from 1980 when the NIMR started to fill with BBC computers.¹⁰²

Pinder: IBMs were also becoming available.

White: IBMs as well, and machine code DEC computers before that. But I remember when I arrived in 1980 that I did in fact use the punch card system and ran a SPICE program (Simulation Program with Integrated Circuit Emphasis) as a circuit analysis program in a rather ancient machine. But it's a transition period, it was an important thing that affected all the labs all over the UK. The fact that you could now connect a small computer to your experiments and grab the data automatically, you'd have a word processor as well, it transformed every lab, I think. We also had an early system of internet – that damn box, RS232 box. No one can remember the name of it. Everybody hated it, but it did link all the labs back to the computer building. I remember it being hit by lightning once. All the cables ran along the outside of the building – it got hit by lightning and we had to repair every single piece of equipment in every lab.

Chambers: I can't remember the name of the black box but I do remember one of the outcomes of receiving this grant was that we managed to buy an IBM PC, one of the very first IBM PCs. Do you remember this, Ian, that we got this IBM

¹⁰² See Appendix 4 by Mr Steven White for a discussion of the computers at the NIMR.

PC to do AutoCAD on and it was literally the first IBM PC in the building and we had a queue of scientists round to see this PC in action? I thought that was literally the start of the PC getting into Mill Hill.

Sutherland: I think that is right but all I wanted to say was a big thank you to Geof because he was the one who was very interested in these sort of computer systems, and I can remember him showing me this new thing called a spreadsheet and I just hadn't a clue what it was and what its benefits might be. But a big thank you, Geof, because it's been so powerful throughout my life since. [Laughter]

Marsh: This is quite an important story because at Mill Hill there were the large mainframe computers and then personal computing came along with Sinclairs, which were the very first PCs – we didn't really have many of those at Mill Hill, we started off with BBCs. The thing about the BBC was that it had a user port, which you could stick electrics into and it would then digitize that and you got it in digital form. That meant you could take the output from an experiment and you could use the computer to do what we'd been designing kit to do for years.¹⁰³ So we decided that the way forward for electronics was, instead of building lots of pieces of equipment, we would just use BBC computers, and we'd just build a little bit of an interface and then we could throw the interface away. Because the snag with what we usually did was that you'd built a piece of kit, it would take months to build, cost a lot of money, and in a year it was thrown away. Whereas, if you used a computer you could reuse that and you would just throw away the little bit of transducer that we'd built. Then, of course, not long after the BBCs we got the first IBMs, it wouldn't be the same one you got, Geof, it must have been the Intel 8086 ones that came in. I've forgotten what they called them now.

Of course, there was then this big issue with computing. They'd said: 'They're rubbish. Computers are things that take up room with fans and power supplies and all sorts of things, and these are Mickey Mouse, we don't want to know.' But all the scientists loved them because they could start doing their own word processing and the next thing you knew they were writing their own papers and the secretaries didn't know what to do – they hadn't got a clue, they were used to IBM golf ball typewriters and suddenly these computers came along and they were wanted to do word processing. The first piece of software we used was WordPerfect on the IBMs and no one knew anything about it. We did, because

¹⁰³ See also the comments on the BBC microcomputer by Professor Ronald Bradley at the Witness Seminar on the history of British intensive care: Reynolds and Tansey (eds) (2011), pages 34–5.

we'd had them in Electronics for a bit and Eleanor King, who unfortunately is not here today, then eventually stopped doing electronics and went around giving WordPerfect courses to all the secretaries. That's another story...¹⁰⁴

White: I'd just like to say something about introducing the BBC computer; I think it pretty much phased out the IBMs in terms of numbers, didn't it?

Chambers: I remember IBM PCs were banned ('disapproved of') originally by Computing and we had to buy Apricots, I think. Prior to that there was something called a Black Diamond, which was a giant word processing machine that was virtually impossible to use.

White: At the same time as the BBCs came in, we also got access to microprocessors, the same microprocessors that were in the BBC computer and we started building boards with microprocessors on. Andrew here worked with Chris Bunn on the tympanometer and I remember Chris Bunn was quite a wizard with microprocessor code and wrote his own floating point library in machine code.¹⁰⁵

¹⁰⁴ Mr Jon Marsh wrote: 'When the NIMR computing department was formed it was based around a large "main frame" computer, a Hewlett Packard 3000 series. This was connected to a number of dumb terminals, originally on the first floor near the computer, then later distributed around the NIMR. Other computer mainframes replaced the HP and the department moved to a new purpose-built building and the number of terminals increased and were situated in all divisions. At around the same time small personal computers started to appear, Spectrums, then BBCs and finally PCs. The PC was regarded as not "real" computing by the computing division and in fact was used by most users as a glorified typewriter, but in Electronics we also used them for data processing and control of equipment. So we developed expertise in troubleshooting BBC and the PC problems, of which the divisional users had plenty. So I started PC Support and put Eleanor King in charge of it. This included software and hardware support, i.e. WordPerfect, the later Word courses, and finger problems with setting up PCs and peripherals (printers etc.). Eventually this became so demanding that there were three staff providing PC Support. In my last years at the NIMR this function was transferred from the Engineering Electronics Section to the Computing Department. This was where it should have been from the start, but the service ethic did not exist there in the early days as it did in Electronics; we had always operated part of Electronics as a drop and run assistance for lab equipment problems, and PC Support was a natural extension of this. Computing did not see this as part of their remit (which it probably was not).' Email to Ms Caroline Overy, 26 July 2015. See also Appendix 4.

¹⁰⁵ Mr Geoff Chambers, Director of Development Engineering (UK) at Abbott Diabetes Care Ltd since 1998, recently launched a miniature wearable continuous glucose monitoring system; he wrote: 'Interestingly a consultant to our development team is Chris Bunn ... At the NIMR Chris worked for Jon Marsh and with Dr Andrew Pinder. Furthermore Steve White also was a consultant and significant contributor to Abbott on several of our previous products ... all this is just a way of saying that the legacy of the Engineering team at the NIMR lives on, with the team still being in contact many years after leaving the NIMR!' Email to Ms Caroline Overy, 9 November 2014.



Figure 26: Mr John Sawkins

Pinder: Yes, that was the point I was making earlier really that so many things you just take for granted now, we were having to do from scratch. I think the whole overlap between BBCs, IBMs, DECs and all the rest of it is very confusing because they were all running at the same time. Obviously the IBM PC won out but I think for a time they were all sort of fighting each other and it would be very difficult to actually unravel that story.

Mr John Sawkins: I didn't join the boys until 1981. I took over from Trevor, who has long gone. He was an ex-RAF wireless operator and when I came into the little room that I've inhabited ever since then there were still valve testers. It was like walking back into 1940.¹⁰⁶ To give you a feel for how backward the Institute was, I can remember being called over to the Director's office, because the secretary, I can't remember her name,¹⁰⁷ had what we would call 'a printing problem'. I was expecting to face a typewriter and I was faced with an enormous

¹⁰⁶ Trevor Holman (1922–1996) was educated at Watford Grammar School. He volunteered to join the RAF in 1941 and served in it as a member of the ground crew (wireless and radar mechanic) throughout the Second World War. From 1946 he worked as an electronics technician, including work at Leak Amplifiers (1947–53) and the National Institute for Medical Research (1956–82). Having retired at age 60 from the MRC, he started a new career as a laboratory technician in a local school. Information supplied by Mr John Sawkins, taken from Holman (1992). Email to Ms Caroline Overly, 1 July 2015.

¹⁰⁷ Ms Rosemary de Rossi suggested it was possibly Ms Pauline Townend.

IBM printer. I hadn't got the foggiest idea how this thing actually worked at all and I was the guy who was supposed to repair it. She was the only one who had a printer and an IBM word processor of any sort at all – the rest of the Institute didn't have one. But that sets the flavour that these guys are working in, they really are cutting edge. We muddled our way through the printer by the way.

de Rossi: Could I ask another question about instrumentation because you used to make counters for us for tritium and all sorts of things that were unavailable, which you couldn't buy at the time.

Marsh: Hang on, I've got to get my list out. I've got a list of everything we've made here but I don't remember that.

de Rossi: I think Piper, Pip, did most of it.¹⁰⁸

Marsh: Oh, Pip might have done it. He did some things I didn't understand, he's pretty clever.

de Rossi: For counting and it was so soft, a low energy emitter, it was very hard to count.

Marsh: Tritium, that sounds like radioactivity to me, Rosemary.

de Rossi: Yes, it was.

Marsh: A bit dodgy.

de Rossi: There were a lot more dodgy things than that we used to use.

Marsh: Isn't that the one where Trevor had that clock?¹⁰⁹

Mathison: Early in the 1970s I remember experiments in Mike Gaze's Division of Developmental Biology, studying the development of optic nerve fibres in the South African clawed toad *Xenopus laevis*. The tissues were stained with osmium tetroxide and electron micrographs were taken of 20 to 30 serial sections: a 3D view of these was required – very easy a few years later with computer graphics. After discussions with our engineers, each micrograph was traced in different colours onto a thin square Perspex sheet, the corners of which were drilled to accept steel rods set into a Perspex base. The traced plates were assembled in correct serial order, illuminated from below and viewed at the top to give a 3D picture.

¹⁰⁸ See note 28.

¹⁰⁹ Mr Jon Marsh added: 'Trevor used the radioactive dial on an old WW2 clock instrument (maybe from the RAF) to check radioactive counters.' Email to Ms Caroline Overy, 26 July 2015.



Figure 27: Peristaltic pumps

Another example of Engineering Department collaboration is as follows: non-invasive/non-contact methods of pumping liquids were needed, e.g. for liquid chromatography and for the supply of media to continuous bacterial growth apparatus such as bactogens. The Sigma motor pump from the States involved three bars compressing plastic tubing, useful but not pulseless. Our engineers took on the challenge, producing marks 1, 2, and 3, etc., starting with a one-speed delta drive and finishing with a variable multiroller system which produced a pulseless flow. These pumps were perfected by companies such as LKB and are widely used, e.g. in dialysis units. In my garage I have, Mark 1, Mark 2, and Mark 3 of these peristaltic pumps, which were on their way to the tip ready to be thrown out.¹¹⁰

Morris: You could offer them to the Science Museum and we'll see if we'll take them or not. I can't make any promises, it would have to go through due process but we could certainly consider it.

¹¹⁰ Subsequent to this Witness Seminar Mr Ian Mathison wrote: 'The peristaltic pumps which I had in my possession have been donated to the "NIMR Museum".' Note on draft transcript, 18 November 2014. Mr Jon Marsh added: 'There is talk of a "Museum" at The Crick. Many of the artefacts are being conserved at the moment at the NIMR using a grant from the Arts Council I believe. The plan is to put on an exhibition using some of these items to tell the history of the science at The Crick (eventually), the remainder of the items will be stored.' Email to Ms Caroline Overy, 16 February 2016.



Figure 28: Dr Anthony Travis

Marsh: When I first started at Mill Hill and we used to get outputs from experiments in the form of graphs; in order to find out how much stuff there was in a sample we would cut out the graph paper and weigh it on a balance. This was incredibly long winded and John Lewin – I think John thought this up, correct me if it was anybody else – developed a system, which we called a planimeter.¹¹¹ He thought it up and I built it. It was a graticule and you'd lay the graph paper on a pad and you'd trace round the graph with your pen and as you went up the graph it increased the volts on a potential. As it went along to the right it integrated the voltage, the more you could get in the graticule the more accurate it was. Then you got a number at the end and this number was proportional to the area under the graph. That principle is in pretty well every piece of kit that's used for outputting experimental data nowadays. Nobody cuts out graph paper any more and weighs it on a balance. I think John invented that. Or he didn't invent it but he used the technology to improve life for people.

Travis: Just a couple of points, Jon. The paper and scissors work was typical of, for example, gas chromatography. It was actually described as a standard method in publications – that was the way you did it. I'm very interested to know whether or not the device you just described was originally invented at

¹¹¹ See Appendix 5.

the NIMR because, if so, it's quite remarkable; in came the integrators and this replaced cutting, the scissors, and bits of paper, which people today think was a primitive means of measuring the amount of material.

Marsh: I don't know, Tony. All I know is that we worked in a room, we knew there was a problem, we solved the problem. Whether somebody else had solved it in America at the same time, I have no idea. All I know is that that was a problem we had and we solved it. The other big advantage of it was, of course, if you have an output that has got two areas under the curve and you cut out one of them, you've screwed up the other one, haven't you, if you see what I mean, because you've destroyed it. Or you could cut out a bit of that and add a bit of the other one. Just imagine, so if you've got overlapping curves... It was a real pain, it was very difficult. So, to be able to run round with this thing that John made to get your output number was brilliant because you could then go around the other curve; you didn't destroy any of the graphs or anything like that. Whether we developed it or not, I don't know.

Travis: I remember when I was doing my doctorate, for example, we would have the traces and we'd measure the height and half width and we would calculate on that basis.

Marsh: Not so accurate, Tony.

Travis: Again, yes, not so accurate, so that emphasizes how remarkable this innovation was.

Marsh: Well, I've always thought it was one of his highlights.

Travis: Well, if that's the case I think it is a remarkable innovation.

Pinder: One of the great things about being in Engineering is the way we would actually integrate into the work of the Institute as a whole. Sometimes it would come about as a result of something, as John [Sawkins] said – you had a piece of kit fail, a valve blows up or something, he goes into repair it and then it starts a conversation saying: 'Hey well, there's got to be a better way to do it than that.' Sometimes it would be the other way around, from a scientist saying: 'You know, I want to measure this, how do you do it?' So we were actually getting projects from all sorts of different levels, from all sorts of different people and nowadays there's a lot of emphasis put on facilitating conversations. Well, those conversations were happening in the 1970s in Mill Hill simply because we were Engineering and we got involved in the nuts and bolts as much as the strategic thinking.



Figure 29: Mr Roger Hooper

Sutherland: Leading on from that, I think Andrew's quite right, we often used to be asked to do the most weird sort of projects. I want to bring Roger in here, he hasn't talked much yet, but you may remember working with Brigid Balfour?¹¹² She was from, I think, Immunology but she had these huge pigs down in the valley¹¹³ and she had these pigs anaesthetized and she wanted to move their legs because if she kept their legs moving it would actually produce something in the lymph nodes; I'm not quite sure what it was she was harvesting. I can remember Roger playing a major role in developing the equipment for that.

Mr Roger Hooper: Yes. I believe they were draining the lymph gland and they found it better if the pig was anaesthetized and there are all sorts of problems with this. If you anaesthetize a pig you've then got to get it up onto a table, and

¹¹² Brigid Balfour (1914–1994) worked in the Division of Biological Standards from 1945 to 1957 and then the Division of Immunology until she left the NIMR in 1978.

¹¹³ i.e. at the bottom of the 'Mellanby Hill'. Mrs Hilary Morgan wrote: 'At the bottom of the "Mellanby Hill" there were houses for staff who needed to be on site at all times to deal with emergencies, e.g. animal staff and maintenance staff. There were also a couple of houses for students. Nearby were the farm buildings and surrounding all of these were fields for the livestock such as pigs, sheep, and cattle. I think the pigs were sometimes in the farm and I remember going along to look at them, but they may also have been rotated in the fields with other animals ... Ron Pratt who looked after the farm animals confirms my memory that the pigs were mainly housed in the farm buildings and says that later they were moved to the Dog Unit, an out-building at the East end of the site.... Philip Draper says that during the time that the Mellanby Building housed the Nutrition Unit, probably back in the 1950s, pigs were kept in an area at one end. This was later used for mice when the building was taken over by the Laboratory for Leprosy and Mycobacterial Research.' Email to Ms Caroline Overy, 25 January 2016.



Figure 30: Lecture by Dr Anthony Travis

we had to develop different lifts to get it up onto the table. To get the walking action of the pig I believe we used a windscreen wiper motor from a car and a gear box on there with a linkage mechanism that was strapped to the pig's leg; the pig would lie on its back and the legs would pump up and down. It then went on from there; we did do systems where there was a cradle with a gimbal action. There was a saddle on the pig so the pig could be awake and walk around for this but then you had the problem, if you weren't careful, the pig would decide to lie down and roll on all this mechanism.

Tansey: There are some wonderful stories and I think some of the contrast between those of you who were working in labs in divisions and those of you in more central facilities, like Engineering, is really quite marked. Some wonderful stories are coming out that I hope we're going to develop.

We're now going to have another historical talk, this one more directly focused on the NIMR. Tony Travis is going to speak about instrumentation and chemical analysis.

Travis: Thank you, Tilli. I'm going to talk about NIMR developments, specific developments, just for a few minutes, hopefully to fire your imaginations – as we all get a bit older we do forget things so I hope I can – and if you can tell me a little bit more about what I've been doing, I'd be very grateful. So my talk today concerns developments in chemical analysis that took place particularly at the NIMR in the 1950s. [The lecture is reproduced in Appendix 6.]

Tansey: Thank you very much, Tony. Does anyone have any particular comments to make now on Tony's presentation?

Marsh: What makes me so sad is I've got a horrible feeling we've lost all this freedom to innovate. I think we've lost the culture and the environment that led to all this. I don't think we're going to get that at the Crick. I am concerned that this freedom to innovate is lost. Lovelock said in that talk he did on Radio 4 that at the NIMR he had never had such freedom; if he wanted to change his research programme from one thing to another, he went down to see Harington. Harington said: 'Is it good science, Lovelock?' And he said: 'I think it is, Sir.' And he said: 'Get on with it.'¹¹⁴ That sort of freedom is just not there now, and I'm worried about that.

Pinder: Well, I'd just echo that. When I left Mill Hill I went to work for the Biotechnology and Biological Sciences Research Council (BBSRC) in Norwich and the culture shock was something that I found very hard to get over. It was almost like going back in time in that I'd gone from a very free establishment to something that was very rigid, very civil service, not just in scientific terms but in almost every aspect of your working life. It just wasn't the same and the results weren't the same. Nowadays everything has to be milestones and targets, but there is definitely a place for freedom and it does work. Maybe not everywhere, but I think Mill Hill had it and a lot of people don't have it. One could do almost anything. I was there actually specifically to work on hearing research but over my time I was involved in all sorts of things. At one point David Dresser in Immunology became involved in sperm sorting, not human sperm. For some bizarre reason he got an interest in cattle breeding and he was actually allowed to have his own herd and we used to spend time sorting sperm on a high speed cell sorter and artificially inseminating in order to try and skew the sex ratio one way or the other, which was for an industrial benefit.¹¹⁵ That sort of thing is complete spin-off research. It's not funded, it's not predictable.

The other point I'd make and it's sort of related, is that particularly in the latter part of my time, it was a very anarchic institute and again I don't see that as a bad thing. I mean, we've all got hundreds of anecdotes I'm sure of the sort of things that went on but, for example, one wouldn't go down to Neurophysiology

¹¹⁴ James Lovelock was interviewed on Radio 4, *The Life Scientific*, in May 2012, available online at www.bbc.co.uk/programmes/b01h666h (accessed 25 March 2015).

¹¹⁵ David Dresser worked at the NIMR from 1962 to 1994. For his work with cattle, see, for example, Morrell *et al.* (1988).

on a Friday afternoon without a water pistol in your back pocket. It was just the done thing and everybody would do it. [Laughter] I remember another incident: the canteen used to have an interesting mixture of fare and one of the most infamous was something called Spam fritters, which would come up about once a week. Somebody put up a notice, or circulated a notice, I know who that person was but I won't name him, he's not here today, but he sent a notice around the Institute saying that there had been a problem with the Spam fritters and if anybody had had them would they go and report to the medical staff. Well, we all thought it was extremely funny, the hierarchy took it a bit the wrong way and sent round another note. But that was the sort of thing that went on, and it went on routinely. I think it was part of the culture.

Tansey: Are you talking mainly about the 1970s and 1980s, Andrew?

Pinder: Yes, that was when I was there.

Tansey: Does anybody else have any other comments moving into the 1980s? Was there a decline of this culture?

Sutherland: I think we detected a little bit of a decline of the culture because the pump team, Geof Chambers and Steve White and myself, got to work with Howard Jacobs at the Middlesex Hospital, who had read about the insulin pump and said: 'Ooh, could you make us a pump that could give pulsatile infusions of luteinizing hormone releasing hormone (LHRH)?' They'd discovered through experiments with Rhesus monkeys that for women who were amenorrhoeic, who did not have periods, that when they injected LHRH as a big bolus it downregulated, it didn't switch on ovulation. But a little pulsatile infusion every 90 minutes actually switched on ovulation in women who had not ovulated for years.¹¹⁶ So it enabled them to get pregnant if they did the right things afterwards. So we were invited to make a pump, and Steve and Geof, who could tell you more about this, developed this. But I remember being ticked off by Arnold Burgen when I suggested this as a project because he said: 'Sutherland, you're doing clinical research. We do fundamental research here.' So we actually had to do it underground, so to speak. As I happened to have a one day a week appointment at St Mary's Hospital Medical School, where I was working with a small group of bioengineers doing obstetrics and gynaecology, I actually set up a personal fund at St Mary's and we pretty well ran a business through that fund making these portable infusion pumps. They became very successful and a lot of them were required. But unlike the insulin pump, which was a commercial success,

¹¹⁶ See, for example, Chambers *et al.* (1984); Jacobs *et al.* (1984); Mason *et al.* (1984).

this saturated the market – how many pumps did we make? 25 to 50? Because they could reuse them they weren't personal to the individual, so it wasn't such a market. But nevertheless it was a very valuable treatment for these women, who for years had wanted to get pregnant. I can remember looking at Google Scholar – one of the highest cited papers was the one where they said the 100th pregnancy had been achieved using this particular technique.¹¹⁷ As another little aside, I noticed that in the late 1970s/early 1980s, all of the insulin pump papers only had the scientists as authors, but when we worked with the Middlesex Group suddenly Geof and Steve were on as authors as well. I welcome that, I think that was a change.¹¹⁸

Marsh: I just wanted to go back to when you were talking about the change from the freedom to the relative lack of freedom, accountability and all these things I don't like – it did start fairly early on. One of the fundamental problems was if it was perceived that you were doing something that wasn't what the Institute wanted but it was something someone outside wanted. Even with the apnoea alarm – which, in my opinion, was one of John Lewin's most important things he developed, which was a big deal and was very successful; it was very altruistic; it was a wonderful thing – there was an element of disapproval.¹¹⁹ I can remember towards the end of us working on that, we were told: 'Well, we don't really want you doing this sort of thing. We want you to get on and make power supplies or whatever it is the scientists want.' So that was a problem, and I noticed it gradually changed. Eventually, of course, when Rothwell retired and they got rid of all the scientific staff from the Engineering Department, they said: 'We don't want any more of this what they called self-generated research and engineering,

¹¹⁷ Homburg *et al.* (1989).

¹¹⁸ Professor Ian Sutherland wrote: 'What is interesting is that all the work on the insulin pumps (1978–1983) was published as scientists only, despite Geof Chambers, Steve White and Frank Doré making significant contributions. Geof and Steve did not start appearing on publications until the LHRH project (1982–1989) was first published in 1984. By contrast, in the Countercurrent Chromatography Research, Penny Newland and Jeff Dymond were put on a publication as early as 1977. Also in the ampoule sealing project (not mentioned in the Witness Seminar) Alan Delderfield was the first author in 1978 (does this suggest that Holly Hill had a slightly different policy to Mill Hill at that time?). The Cells and Organelles research (1977–1988) did not have NIMR research staff on publications until 1983–1984 when Deborah Heywood Waddington started, although Peter Carmeci, a technician from NIH, was on a 1979 paper.' Email to Ms Caroline Overy, 9 October 2014. See Appendix 8 for a list of publications indicating NIMR Scientists and NIMR Research Officers and Technicians. See also the discussion in Tansey (2008a).

¹¹⁹ For a discussion of the sleep apnoea alarm see pages 91–2.

we want you to respond to requests.¹²⁰ That was again, in my opinion, part of the death knell for the original thinking that would go on. If you get rid of half the good staff you're not going to get such good work – it stands to reason.

Tansey: Do you think this attitude was institution-wide or was it particular divisions that were more susceptible?

Marsh: Well, Engineering was particularly susceptible because it was not a scientific division, we were already a department. It's a subtle difference. Divisions are divisions, departments are departments. We're a department so we're not scientific and therefore we shouldn't be doing any science and we should be getting on making test tube racks and things that we're good at.

Mathison: I've got an interesting document here from February 1974 and it's headed 'The Role of the Medical Research Council' and there's a note by the Secretary of the Council.¹²¹ I'll just read the beginning bit: 'Research is now operating in an environment very different from that which existed throughout most of the '50s and '60s, the most important factors being: (a) changes in the rate of growth of the financial resources of the research councils; (b) changes in the finance available for research through the UGC; (c) problems of manpower, careers and tenure; d) the arrangements specified by the Government White Paper on R&D.'¹²² Paul Nurse summed it up recently by talking about translational research and you can see that's what they're wanting now. They want it to be absolutely relevant and I think it's driven by the lack of finance.¹²³

Wolff: In a sense I was going to say what's already been said. The reason I left the Medical Research Council in 1983 was that I could see the dark clouds on the horizon of a much stricter control of the science. The Medical Research

¹²⁰ Denis Rothwell retired in 1988; see the comments on pages 73–4.

¹²¹ A copy of this document has been archived with the records of this meeting in Archives and Manuscripts, Wellcome Library, London, at GC/253.

¹²² Framework for Government Research and Development (Cmnd 5046, 1972). See the discussion in Reynolds and Tansey (eds) (2000), pages 48 and 51.

¹²³ For the MRC's focus on, and funding of, translational research, see their website at www.mrc.ac.uk/funding/science-areas/translation/about-our-translational-research/ (accessed 26 May 2015), and the strategic plan, *Research Changes Lives 2014–2019*, available online at www.mrc.ac.uk/research/strategy (accessed 26 May 2015). In this plan translational research is defined as 'Research that speeds up the process of turning fundamental discoveries into improvements in human health or wealth', page 47.

Council had operated almost since it was created by having a 10 per cent increase in real terms per year budget. So even if you did things wrong you could buy your way out of it. This was clearly coming to an end in the early 1980s. There was a very considerable mistake made by the Clinical Research Centre, which didn't ever work. Even though it was going to be the jewel in the crown of the Medical Research Council, the Clinical Research Centre didn't quite come off, partly because its putative director died before the building was finished and nobody quite knew what he had intended to happen.¹²⁴ So the question of a tightening of the financial strings, which the MRC had absolutely no experience of operating – they had never had to operate in a climate where the money next year was going to be less or even the same as it had been the previous year – produced a number of mistakes and a number of policies that you've just been describing, which were the initial reactions of there being rather less money. And, of course, research became much more expensive. When I joined the Council the budget was a million and a half.

Pinder: I think there's a fundamental sort of dichotomy between research that is academically good and gets you lots of papers and gets you up the greasy pole, and research that brings in money, which may be not particularly exciting from an academic point of view but is nevertheless a worthwhile industrial type project. I saw it at Mill Hill and I saw it a lot more after that when I went on to the BBSRC. You get one committee after another coming in: the first committee says: 'Oh, you're not publishing enough, you should be doing this'; then the next one comes in and says: 'Where's the money? Where are you bringing it in? Why aren't you spinning this off?', and all the rest of it. Successive governments have said: 'We're addressing this and we're trying to change the balance', but I don't really believe anything's fundamentally changed. You've got to decide what you're going to go for and then go for it. If you want to bring in money then you put a serious team in a serious job and if it spins off a few papers well fine, but that's not the be all and end all. I think I saw it at Mill Hill but I don't think it's peculiar to Mill Hill.

¹²⁴ The Clinical Research Centre, established to provide clinical facilities for the NIMR, was formally proposed and approved in the 1950s, and opened at Northwick Park in 1970. Following the untimely death of Professor John Squire (1915–1966), Professor Graham Bull was appointed Director. For a discussion of the aims and design of the Centre, see Anon. (1966); Anon. (1970a and b); and for a review of the Centre see Booth (1986).

Mathison: I've got a copy of a document here from the Medical Research Council in 1986, from Nick Winterton, which is about Manpower Audit arrangements and the introduction of complementing the positions of technicians.¹²⁵ In fact it's the start of self-justification for your employment at the National Institute for Medical Research. This didn't go down very well but eventually we had to agree to all of this and every year we had to write out exactly what we did and what percentage of time we spent on all these jobs. And the pressure was on then. Then there was a memo in 1989 from Frances Griffiths, who I think was personnel officer at the time, which is headed 'Technical Staff Restructuring' and it's about the assimilation of individuals to new spine points and the regrading of posts. So much greater control was coming in now and I think this really narrowed the wide spectrum that we had in the past. In effect we were being pigeon-holed.

Tansey: I'm sure it wasn't unique to Mill Hill, as you said, but we're talking particularly about Mill Hill. So what happened from this optimism that we were talking about in the 1970s, and the beginning of the 1980s? Things are now changing. What was happening? Those of you who were working in Mill Hill, what changes did you see, how did this impact on your daily lives?

Sutherland: I don't know if this is a correct assumption, but Jon Marsh mentioned that towards 1988 when Denis Rothwell retired¹²⁶ that they decided not to replace him, and the feeling I had at the time, talking to people, was that there was a molecular biology insurgence going on within the NIMR and that there was more directed research coming in saying: 'Don't you think you ought to be working on this sort of approach?' You could tell by the people they were appointing that

¹²⁵ The document from Nick Winterton, Head of Personnel at the MRC at the time, states that 'The basic principle of complementing is that the numbers and grades of staff provided should be directly related to the work which necessarily has to be done'. Complementing in MRC establishments was clarified in an MRC staff bulletin of August 1986: 'An establishment's "complement" may be defined as: "The maximum number of posts, and their descriptions in terms of categories and grades allocated to that establishment to carry out work necessary to achieve its agreed aims." In MRC research establishments the needs of the majority of work situations can be met only with a mixture of *normal complementing and straight-through grading*, where a specified grade level is assigned to a post, and *fluid grading* where the grading of the job is determined by the contribution of the person performing it.' It went on to state that most administrative and maintenance posts were subject to normal complementing; most research officer posts would be subject to fluid grading; and technician posts would be subject to normal complementing or in a few specialist areas to straight-through grading, where staff could be appointed at a lower grade until they achieved the relevant experience or qualification for the normal grade. *MRC Staff Bulletin* 114, page 1 (documents supplied by Mr Ian Mathison). A copy of this document has been archived with the records of this meeting in Archives and Manuscripts, Wellcome Library, London, at GC/253.

¹²⁶ See page 70–1.

that sort of thing was happening, and that's the main reason I left. It's not easy to leave somewhere like the NIMR – when I first arrived in 1973 I had a three-year appointment. I then had to go for tenure; it wasn't tenure straight away, you got a five-year limited term appointment, and then after eight years you could apply for tenure, and in my case I got it and so I had a job for life. The Director then said: 'Okay, well Engineering is disbanding the science, but you can work anywhere, Ian.¹²⁷ You can go into the biophysics, cell biology.' But to me I loved working with the skilled people around me like Jon Marsh, like Geof and Roger and other people, and the instrument makers. Having the intimacy with the workshop was very important. So it was at that time that Heinz very luckily rescued me and I went to work with him. But when I said to Heinz: 'What can you offer me?' he said: 'Oh well, you've got to get your own money in'. That was a real shock to me, going on the outside [i.e. of the MRC]. But the point was what was changing at Mill Hill, and I think it was a molecular trend coming in.

Wolff: Something nobody has mentioned: for some reason or other I was on reasonable terms with Himsworth and I also knew his son, Richard.¹²⁸ On two occasions I had major discussions with Himsworth, young man that I was, about the demands made by the Department of Health about the contractor–customer principle.¹²⁹ There were two major attempts made by government to make some of the MRC budget dependent on the MRC doing things which the Department of Health wanted to do. And there was a defensive reaction that this should not happen.¹³⁰ I was told by Himsworth, you mustn't ever say anything which in any way supports the contractor–customer relationship.

¹²⁷ Professor Ian Sutherland wrote: 'When Denis Rothwell retired they decided not to appoint a new scientific head of Department and disband the scientific side of Engineering – keeping on the workshop just as a service function. Tenured scientific staff like Mike Anson and me were asked to move to another department or division.' Email to Ms Caroline Overy, 13 August 2015.

¹²⁸ Sir Harold Himsworth (1905–1993) was Secretary of the MRC from 1949 to 1968; his son, Professor Richard Himsworth, worked at the Clinical Research Centre at Northwick Park from 1971 to 1985 with research focused on clinical endocrinology.

¹²⁹ The contractor–customer principle was proposed in the 1971 Rothschild Report, 'The organisation and management of government R and D', where the Government department or Chief Scientist was the 'customer' and the Research Councils and Universities the 'contractor': Great Britain, Parliament (1971). See the discussion of the Report in the Witness Seminar on clinical research in Britain, 1950–1980: Reynolds and Tansey (eds) (2000).

¹³⁰ The Rothschild Report proposed that about a quarter of the MRC's budget be transferred to the DHSS, which would then commission the MRC to carry out research, on the contractor–customer principle. For a review of the report, along with the Dainton report published at the same time, see, for example, Dobbs (1972).

Tansey: I can see how Engineering became a service, and there was this sense that you were going to do what other people asked you to do or told you to do. What about in the other divisions or departments? Those of you in Immunology and Nutrition – were these changes happening at the same time?

Morgan: The point I wanted to start off with was saying that the Institute was set up for what I always called long-term fundamental research. It wasn't something nitty-gritty, tackling problems of the moment. It was looking ahead and giving people, or giving the scientific world in general, something to build on and progress from there. The only two divisions or labs that I could see in the Institute that were doing work of the moment were Parasitology and Leprosy.¹³¹ I think that is one of the reasons why it's particularly hard to get money in grants for this much longer-term research, and perhaps it's just killing itself in some ways because of that. I'll just take this opportunity to say as well, that we were working in the Mellanby Building, distinct from the main building, and it was a kind of different, self-sufficient, atmosphere down there for us because we had to bring all our stores down and find places to keep it. As those of you've who've done it will know, it is quite a steep hill to run up and down and because of that we didn't go up to the canteen very much. Philip Hart¹³² would go every day and get his Milk Flake but we had our own coffee room on the top floor of the building where we had Christmas parties and would bring microwaves in and heat up the roast potatoes and the meat and things like that. We had to know how to look after the building ourselves. Trying to get Maintenance down there, to come down, 'yes, yes, they'd come' but we'd be stuck. The autoclave wouldn't work, you'd then have to take stuff up the hill somehow. So we got a little old milk float from the local dairy and trundled up the hill with that and took everything around – it was interesting. We even had to bring our own heaters in to get heating in the winter and we suffocated in the summer. So it was a shock when we moved up to the main building and I have to say I only had one year up there and I didn't mind retiring.

Sutherland: You just mentioned Christmas parties and I noticed you had NIMROD on your list.¹³³

¹³¹ See further comments by Mrs Hilary Morgan on leprosy on pages 101–2. Mr Ian Mathison added that vital research on antibiotic resistance was being carried out in the Microbiology Division. Note on draft transcript, 18 November 2014.

¹³² Philip D'Arcy Hart (1900–2006) was Director of the MRC's Tuberculosis Research Unit from 1948 until his retirement in 1965, after which he moved to the NIMR to study the cell biology of *Mycobacterium*; see Tansey (2009).

¹³³ NIMROD was the NIMR's social club and was open to all staff members.

Tansey: No one's mentioned it so far.

Sutherland: I did want to mention NIMROD because I think it played an important role within the organization as it was a social club. There was a bar in the restaurant area and the restaurant area itself also played an important role because it was the mixing place for people to come and have lunch and sit with different people at different times. But we also, as NIMROD, used to organize cricket matches, interdepartmental cricket matches, down in the valley. That valley is a beautiful place – it's absolutely fantastic. Also, when I was chairman of NIMROD for a short period, and with Roger Hooper's encouragement, there was talk about whether we could negotiate use of the swimming pool at Mill Hill School. We managed to do that and so at lunch time we could wander along to Mill Hill School and use the pool, which was a fantastic asset. At other times we had competitions like a hot air balloon competition. I remember once where we all made balloons and let them off down in the valley. And I, being a scientist and inquisitive, I'd researched the best sort of insulated material.

Marsh: You cheated.

Sutherland: Probably cheated. I'd managed to get this mylar material¹³⁴ – you could iron and seal it and so on – and built this huge balloon. Anyway, I put all this hot air in it and it just disappeared. It went over the hill and went over the motorway and I never got it back. I chased it in the car but apparently some kids on an estate were seen taking it away and hiding it. I don't know if anyone else has got any anecdotes around NIMROD, but the Christmas parties were really wonderful. I know my children enjoyed those parties, and there were also the other Christmas parties that I remember Jon Marsh enjoying but I don't suppose you want to go into detail. [Laughter]

Marsh: While we're talking about the Christmas party for the children, which Ian's talking about, I was organizer for that for I don't know how many years.¹³⁵ I remember the first year I did it, this is nothing to do with science, this is an anecdote, I was absolutely petrified that it would go wrong. The main thing was we had these two entertainers called Naughty Uncle Wally and Auntie Wendy who would come in and they would do the bulk of it. The main problem I had

¹³⁴ Mylar, a registered trademark of Dupont Teijin Films, is polyethylene terephthalate sheeting, which was developed in the 1950s and is widely used in, for example, electronics, insulation, packaging, and printing.

¹³⁵ Mr Jon Marsh wrote: 'For about ten years I was the Children's Christmas Party Organizer. I think they were held on a Saturday ... There were around 100 children between the ages of 4 and 12. It was about a three-hour do, if I remember rightly, and quite a big operation...' Email to Ms Caroline Overy, 26 July 2015.

was whether they would turn up. I can remember being there on the steps of the Institute thinking: ‘God, Wally and Wendy haven’t turned up. Oh, thank God they’re here. That’s alright.’ The other thing we had to do was to buy presents for every child and they were all individually selected – I had a list of what they had the previous year so they didn’t get the same thing. A girl called Margaret Moran and I used to go down to a dealer, Maurice Manning, down in West Hendon to sort these presents out. There were mouth organs and God knows what – good stuff, wasn’t it? We also had Walt Disney cartoons – this is before television had cartoons on. We used to get those from the Rank Organisation in the Great West Road – they had a place there. You could hire 16mm films, and that’s another little story about the 16mm film projector. Pretty well the only reason we had the 16mm film projector at the Institute was to show the films for the children’s party. I don’t remember it ever being used for any science at all apart from that one time when Huxley came down.¹³⁶ The food was the other thing we had to organize.¹³⁷ The party was a really good event, wasn’t it? Great for the kids.

The Institute was a fabulous place to work, absolutely fabulous. The number of people who’ve left and said to me, and as Russ said earlier on today: ‘When I left I’ve never found anywhere like that to work.’ I used to organize days out for the staff if I thought they’d been good, which they had been most of the time: we went to the Norfolk Broads one day; we went on the Waverley Paddle Steamer down to Southend and back; we went to Beckton Sewage Works. I can’t remember all the things we did. It was all good stuff.

Turner: Could I just say something following on really on the social side of NIMROD and starting off with the children’s party. I’m not sure if I took over from Jon or someone else subsequently but I was the one that sacked Uncle Wally.

Marsh: Oh, were you?

¹³⁶ Mr Jon Marsh wrote: ‘[Sir Andrew] Huxley phoned me from Cambridge, he was giving a seminar at the NIMR and wanted to show some 16mm cine film. I told him we had a projector and searched around for some film to test it before he came. This was when I found the 16mm film of the opening of the NIMR in 1950, with the King and Queen etc., which was gathering dust on a shelf in Engineering, nobody knew what it was and I found out by running it. This film, and other archive material I copied to DVD (and sent a copy to the current Queen). It was only due to Huxley asking about the projector that meant this film was ever discovered, it would have been binned like so much other history of the NIMR.’ Email to Ms Caroline Overy, 26 July 2015.

¹³⁷ Mr Jon Marsh wrote: ‘...we gave all the children a meal (sandwiches, jelly, cakes, etc.). I got volunteers from the canteen staff to do this and other volunteers to serve it etc.’ Email to Ms Caroline Overy, 26 July 2015.

Turner: Yes, and I got a huge amount of stick from certain people. I mean he was awful in later years. The kids loved him but the adults cringed. He's not for the adults, I know, but I was the one and I can proudly put my hand up to say I was the one that didn't employ him and had someone else. Also, talking about social life – something we didn't talk about really from the 1970s when I joined the Institute was the integration of technical staff and senior staff. I think it began to happen in that period and I think a lot of the NIMROD social events that have been mentioned were very helpful in that. Certainly I'd come down with this MRC Unit from Cambridge and I knew no one. I was a single man living in London, you know, first time away from friends and family and we weren't universally welcomed to the Institute because we were Arnold Burgen's unit.¹³⁸ And Arnold Burgen, when he took over, I think was not a universally popular man coming to the Institute, particularly following Peter Medawar, whom I understand had been much loved and sadly had to give up the Directorship.¹³⁹ So I was very reliant on a few people at the Institute, whose names I won't necessarily mention, taking me under their wing and integrating me socially at least into the Institute. We had tremendous fun. Someone talked about the anarchy and things that went on and I can certainly lay claim to being involved in some of those. For example, in 1976 we produced a pantomime, which some people might remember, which was for one night only but it was a fairly lavish stage show and it was written and produced by myself and Mick Errington, who's a name that undoubtedly crops up when you talk about the Institute.¹⁴⁰ That was quite a revolutionary thing to do. We sold tickets and raised a lot of money for charity and had tremendous fun putting it on. We had a wide range of people who were part of the cast. We had Jim Feeney, who

¹³⁸ See pages 36–7 and note 64.

¹³⁹ In 1969, at the age of 54, Peter Medawar suffered a severe stroke, leaving him partially paralysed. He continued as Director for two years, but, with concerns over his ill-health, he resigned his post in 1971 to become Head of the new Transplantation Biology Department at the Clinical Research Centre.

¹⁴⁰ Mick Errington was among the technical staff of the Neurophysiology Division working with Timothy Bliss on long-term potentiation (LTP). Mr Peter Turner wrote: 'Mick was already a "character" at the NIMR and became a close personal friend (and still is, being my son's Godfather). We found we had a similar sense of humour and fun and immediately hit it off. He and other members of his Division were some of the first people at the NIMR who accepted us and helped me and others from the newly arrived Cambridge group to assimilate into the culture of the NIMR. The two divisions became close and held joint social events and particularly wicked Christmas parties. He started at the NIMR well before we arrived in 1972 and retired, I think, probably around 2005/6'. Email to Ms Caroline Overy, 1 July 2015.

was head of a division, or he was Arnold's deputy in Arnold's division;¹⁴¹ we had John Woodcock, personnel officer,¹⁴² and quite a few other people. Putting that on is certainly something I shall always remember. The bar also had quiz nights, discos, again I ran a disco in those days and probably introduced it to the Institute – I don't know whether I was the first but I certainly did regular ones there. It helped me tremendously to integrate and I think at that time there was a great camaraderie and lots of people in the Institute who did get together on a social side. But that's the late 1970s really.

Tansey: Can I just ask you, by this time was NIMROD an Institute-wide social club or was this still technicians, because it started as technicians?

Turner: It was open to all but it tended to be predominantly technical staff, I think.

Mathison: Yes, it bridged the gap considerably. I'd like to say that visiting scientists came from the States, Poland, Russia, Hungary, Romania, South Korea, Greece, Iran, India, Japan, Australia, Israel, and other countries, and many of them joined in the sports and we actually taught the Russians how to play cricket and they enjoyed that. We had five-a-side football and '20-over' cricket; it was great fun and I agree with everything Pete was saying. It started to end the old hierarchy system and we all blended together quite well. I've got a nice story to tell about Sir Peter Medawar. He enjoyed his cricket very much and I was playing in the same game when we played, I think this was against Armstrong Cork near Edgware General Hospital. NIMROD were doing rather badly because the opposition had quite a high score and we were batting – I think number nine and ten were batting, and it looked as if we were going to lose. Sir Peter, a very tall man, was watching with his arms leaning on a hedge. We were standing to the left and right of him on lower hedges and number nine and ten batsmen started to score runs and it looked as if we might win the game. He became so excited that he started to lose his balance and it was

¹⁴¹ Dr Jim Feeney (b. 1936) joined the NIMR in 1972, becoming Head of the Molecular Structure Division (1988–2001), and was Controller of the MRC Biomedical NMR Centre from its establishment in 1980 until his retirement in 2001.

¹⁴² Mr Peter Turner wrote 'John Woodcock was Head of Personnel/Personnel Officer during this time and I think he came to the NIMR, or went from the NIMR, to MRC Head Office in Park Crescent. Although well up in the hierarchy of the NIMR, he had a good sense of humour and participated in many social events.' Email to Ms Caroline Overy, 1 July 2015.

like slow motion as he gradually crunched into the hedge. We managed to save him, grabbing hold and pulling him out of the hedge. He was more concerned about the damage he'd done to the hedge than anything else. He was a lovely man.

Sutherland: Did you win?

Mathison: No, we didn't win. When we played at Harwell it seemed that he knew the MRC Director at Harwell quite well and they were friendly rivals. I remember being in the field, they were batting and the Director of Harwell was batting and Peter Medawar was fielding at mid-on. The Director, having been bowled a rather short bowl on the leg side, hooked the ball and it looked as if he was going to score a six; I looked around to see Sir Peter Medawar just put his arm up in the air, and not even looking at what he was doing, catch the ball cleanly. The look of pleasure on Sir Peter's face and the horror on the Director's face was quite interesting. So those were two stories about Sir Peter Medawar. The other one is very early days, of course. I'm almost certain I remember seeing Stephen Hawking as quite a young lad at one of the NIMROD Christmas parties. Frank Hawking, his father, worked in Parasitology. I don't know how old he would have been then, maybe about 12, of course there was no sign of his problems then.¹⁴³

Mr Russell Higgins: I was just going to add to what Jon said before. I first came to the NIMR as a Ministry of Defence student and I've no idea how the relationship occurred in the first place, but I was sponsored at university and we had to work the summer period. We were asked where we wanted to work and we had no real idea, but the option came up to go and do electronics at the NIMR, which sounded an interesting option. So I came with one of my colleagues for the summer – that would be 1986 I think – and we enjoyed it so much we came back the following year, and then two years later I came and worked permanently. The thing that I remember is that we were made extremely welcome, it was like a little family in Ronan Cottage. It was an awful lot of fun. We had days out, I think Jon mentioned the trip to the Broads already; we used to go swimming in the Mill Hill School pool; I vaguely remember a trip to the Docklands Light Railway (DLR) the first week it opened. It was terrific. I've never worked anywhere like it since; I've an awful lot of fond memories.

¹⁴³ Professor Stephen Hawking (b. 1942) was Lucasian Professor of Mathematics at Cambridge from 1979 to 2009. He was diagnosed with motor neurone disease in 1963; see his website at www.hawking.org.uk (accessed 27 May 2015). For Frank Hawking see note 22.



Figure 31: Mr Russell Higgins

Marsh: You said you didn't know how we got you – I'll tell you how it was: we couldn't get any money for staff and somehow I discovered that we could get these students from the MOD (Ministry of Defence), and I also discovered that they were bloody good; the MOD had already been around all the universities and picked out the best students and got them. I thought: 'If we can get these blighters in for their six months, or however long it was in the summer, to do some work for us, we're going to get some good electronics for nothing!' That's why you came.

Higgins: We'd come through the MOD as apprentices.

Marsh: Yes, I'd gone to some procurement bloke, who I used to get on to, and with you and some of the others, we thought, because you'd signed a contract hadn't you, saying that you wouldn't go to work for anybody else after you got your degree or whatever it was.

Higgins: Yes, that's right and then I was posted up to Scotland, which I wasn't particularly happy about when I'd asked not to go there, and I did my minimum time and I remember phoning you up and saying: 'You haven't got any jobs going by any chance, have you, Jon?' And you said 'yes', because Martin King was on the verge of leaving, so that's when I came and replaced him.



Figure 32: Keeyok, the NIMROD Social Club boat, in the boatyard on the River Hamble.

Marsh: Well, it was difficult to get good people. As Heinz said earlier, the bottom line was money, and that's why everything changed. Money became more accountable, there was less of it, and we were going to be the first to be hammered. They weren't going to stop the scientific staff departments, Engineering was going to get reduced. We were reduced and reduced and I had to get good people, and if I could get them for nothing that was brilliant. Another good thing about it was we knew he was good because we'd had him twice and we thought, yes, we'll get this guy and he's going to do some good work for us. It was the same for some of the other lads as well.

de Rossi: Can I add some more things about NIMROD? We had a sailing club. Martin Pollock¹⁴⁴ donated a yacht called Keeyok. Did you go on it?

Marsh: I did, I went with Norman Gregory.¹⁴⁵

de Rossi: We used to run the sailing club and all Martin Pollock wanted was a Victorian shilling because you have to buy yachts. So we got this Victorian

¹⁴⁴ Professor Martin Pollock (1914–1999) worked for the MRC from 1945, and was Head of the Division of Bacterial Physiology at the NIMR from 1949 until 1965 when he was appointed Professor of Biology at the University of Edinburgh.

¹⁴⁵ Norman Gregory (b. 1930) was a Technical Officer working with James Lovelock on the argon and electron capture detectors in the late 1950s. See further details in the paper by Dr Anthony Travis in Appendix 6.

shilling and paid him. I think a lot of people enjoyed the sailing until a lady in Biochemistry went and hit a buoy when she wasn't looking where she was going and then we had a big repair bill. We also had a shooting club, all sorts of people came to that.

Marsh: We didn't shoot the right people though, did we? That was the problem.

de Rossi: No, no, that's right. We used to go down to Inglis Barracks, which was just down the road, and use their shooting facilities but we had our own guns. In fact I've still got one of them at home now.

Marsh: Yes, I had the gun for a bit as well. But going back to the ship, you said we did lots of sailing, actually we didn't do a lot of sailing but what we did do a lot of was fixing the boat. In the winter we used to go down to Deacon's Boat Yard, on the Hamble, and spend the weekend there. It was brilliant because Keeyok was a four-berth boat, and we'd go and we'd sleep on the boat. We'd probably take some girls down there or something to help do the rubbing down, you know. [Laughter]

de Rossi: Yes, NIMROD had lots of facets to it so there was something for everybody indoors or outdoors. We also, as we mentioned, had cricket matches and we also had dances in the early days with bands, everybody dressed up in evening dresses.

Tansey: When you say early days, Rosemary, when do you mean? 1950s?

de Rossi: It was in the 1960s, I think.¹⁴⁶

Sutherland: They say it's important to get a good work–life balance and I think NIMROD did help us to do that. I would like to thank the organization for a start for people like Andrew Pinder for his sailing enthusiasm, NIMROD for its sailing club, and also the fact that we could join the Civil Service Sailing Association as a consequence of working at the NIMR. That was something I did at the time I was there and therefore got my yachting training and as a consequence I really enjoy that now in my semi-retirement.

de Rossi: The other thing I must mention is at one of the Christmas parties we used to have Father Christmas visiting, giving the presents out to the children. Peter de Rossi, my husband, did it one year; he was coerced into doing it because

¹⁴⁶ Mr Ian Mathison wrote: 'I remember the dances from 1955 or so, in the Fletcher Memorial Hall.' Note on draft transcript, 18 November 2015.

nobody wanted the job.¹⁴⁷ And when our son went up he came back clutching his parcel, he said: ‘That’s not Father Christmas, that’s daddy, I know his shoes!’ [Laughter]

Marsh: I just want to say something about Denis Rothwell; of course, as well as being head of Engineering he was a concert pianist of fantastic quality. He was very, very interested in music and he would organize music soirées at the Institute, and one of those he organized wasn’t at Mill Hill, it was at a church in Hampstead. It was the memorial service for Bob Honess who died in 1990 where Emma Kirkby sang.¹⁴⁸ That was pretty good.

White: One thing that hasn’t been mentioned is that a lot of people met their partners at the NIMR, myself included, and Geof for example. That was partly due to going on the NIMROD trips. One of the trips that hasn’t been mentioned was the mountain climbing: hiring one or two 15-seat minibuses to carry up to 30 people, renting small hostel-type places, bunkhouses. There are many stories from that. But yes, I met my partner on one of those trips.

Marsh: There’s one little story and it’s very brief. I went on one of these trips – I was very keen on this. We went to this mountaineering hut in Llanberis and I remember thinking how bloody heavy my rucksack was, and I thought: ‘What is this?’ I went to bed eventually and I unpacked it and in the bottom were two or three enormous transformers that the blighters had found in the storeroom and put in... yes, thank you very much. [Laughter]

de Rossi: Another outing that John Lee used to organize regularly every year was a day out at Ascot.¹⁴⁹ We used to have a coach, a lot of drinking, and a lot of eating – it was a very good day out.

Mathison: I’ve got the NIMROD section organizers list here, 1989–1990. It lists all the available things: aerobics, arts and science, opera, ballet, theatre, badminton, basketball, the Buckland Society (weight training), cricket, film

¹⁴⁷ See note 71.

¹⁴⁸ Dr Robert Honess (d.1990) worked in the Division of Virology from 1976, becoming head of Division in 1987. His research focused on herpes viruses. Dame Emma Kirkby (b. 1949) is an English soprano.

¹⁴⁹ John Lee (b. 1928) joined the NIMR as an apprentice technician in 1949. He worked in the Chemotherapy Division until 1966, when he became Technician to Dr Howard Rogers in the Microbiology Division, becoming Head Technician in 1969. He worked in the Microbiology Department until 1987. The edited transcript of an interview with John Lee, conducted by Dr Pamela Lear, will be available online at www.histmodbiomed.org.

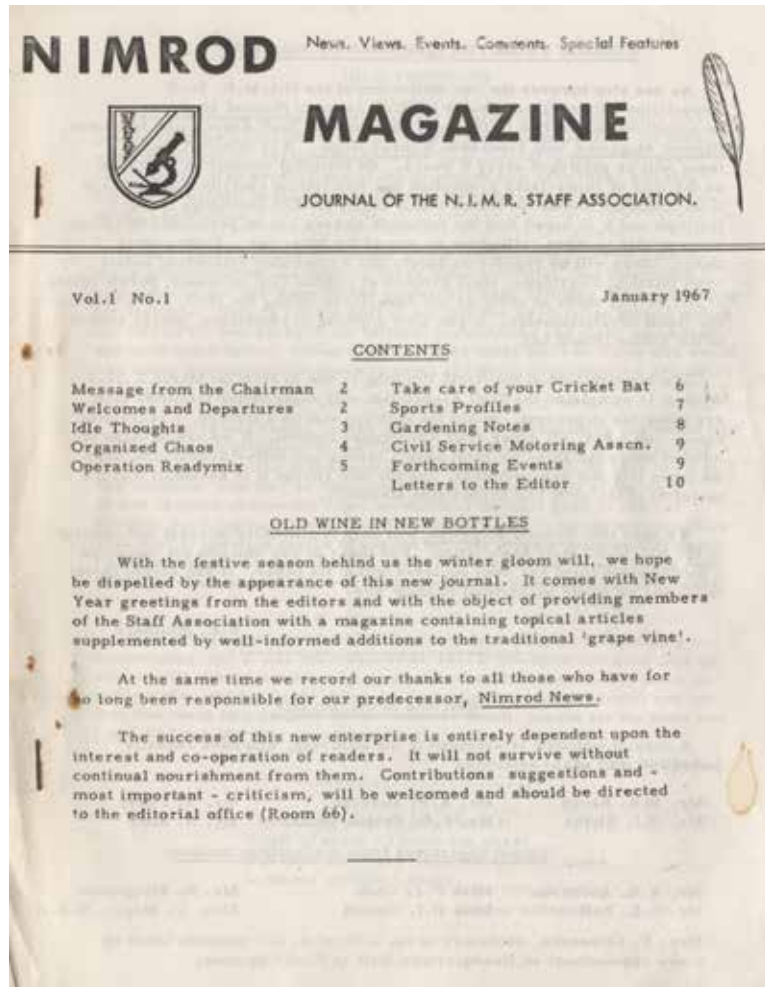

Figure 33: NIMROD Magazine (1967)

sales, fireworks, football six-a-side, gardening, golf, indoor sports, library, magazines, cycle maintenance, motoring, mountaineering, advertisement board, the *NIMROD News*, sailing, surfing, singers, squash, swimming, tennis, volleyball, yoga, and wine.

Chambers: While we're on the subject of Nimrod there was, I believe, some sort of alternative *NIMROD Magazine*, *Not the NIMROD News* or something, and there was a writer in that called Buffy Frobisher. So who was Buffy Frobisher? Come on.

Marsh: I know who Buffy Frobisher was.

Mathison: I have a theory.

Marsh: I have a fact.

Mathison: I may be wrong but I think it might have been Terry Jarrett.¹⁵⁰

Marsh: Wrong.

Mathison: Wrong? Okay.

Marsh: It was Rod King.¹⁵¹ [Laughter]

Mathison: I have some past copies of the *NIMROD Magazine* here.

Sutherland: I just wondered if I could share with you one anecdote on the insulin infuser pump.¹⁵² I know you were asking what can go wrong and why can projects sometimes fail. On one occasion we were getting very near the final stages of the commercialization of this particular pump. The electronics were working beautifully – everyone thought that was going to be the rate-limiting factor but actually it was working really well, and we had this sort of syringe driver with the piston, and we found that every one in ten, or possibly one in twenty, of these syringes that came suddenly got stuck and wouldn't move at all. Consequently the spline drive would bite out – in other words it would just go round and it wouldn't drive at all. This was a real worry. Most of them could move very easily, you could just push them with your thumb and they would move very easily. So I travelled to Germany with one of the representatives from Nordisk, the company that was manufacturing this pump with us, to go to the plant that was making the devices for us. This was an excellent lesson for me in observation because we couldn't understand why some were perfect and others were not. So we had to study the way that they siliconized the glass syringes. We found that they assembled about 100 at a time in these big baskets and these baskets were dipped manually by a gentleman into this siliconization fluid, and then brought up again, allowed to drip for about 30 seconds and then put on a conveyor belt where they went along and within about 30 seconds they were in an oven where they got baked. We were disciplining ourselves to take a note of the whole process, what time they went into the oven, how long they were dripped and so on, when suddenly there was a ding a ling a ling a ling a ling, and everybody left to go and have a tea break. We noticed that one of the trays

¹⁵⁰ Terry Jarrett was Finance Officer. He joined the NIMR in 1948.

¹⁵¹ Mr Peter Turner wrote: 'it was actually Rod King and Peter Turner'. Note on draft transcript, 1 October 2014.

¹⁵² See earlier discussion on pages 52–7.

had been left having been dipped in the silicone fluid and when they came out again, about 15 minutes later, this was put straight onto the conveyor belt and went straight in the oven. Ultimately it was that one that turned out to be the one that actually had the very high stiction, static friction, and was causing us the problems. So once we'd identified that, of course we had to then insist that the whole process was automated so that there was no break. Unfortunately they couldn't have a tea break. But it was a very interesting lesson to me how you have to absolutely make sure everything is done correctly in terms of the protocol for siliconization. After that everything worked perfectly and the pump was a great success.

White: Ian, I just want to add one thing, that it wasn't plain sailing with the electronics. You have a battery, you have some electronics, and a motor driving a syringe. Any failure in the electronics that can put a current straight through the electronics into the motor could be lethal. If the plunger moved 2mm the patient was dead. So I wouldn't want to do that project these days, having been involved in medical recalls in the past. These days I would think the infusers have a great many backup systems. In the NIMR infuser, for example, there were 15 separate alarms in the electronics, but if the syringe plunger moved 2mm I think the patient would be dead. It's quite easy for electronics to fail as a short circuit, which might allow current to flow to the motor if there were no fail-safe mechanisms.

Pinder: Following on from that I just want to ask a question of the pump team: nowadays one is used to all sorts of litigation and liabilities and ISO 9000 and God knows what.¹⁵³ But what was the liability of Mill Hill? Basically, what was your traceability? Supposing something had gone wrong – were you covered for that?

White: I don't think we were covered really. That's what gave me nightmares.

Marsh: Well, it shouldn't have given you any nightmares because the MRC, as I understand it, has always underwritten its own problems. It's never had any insurance of any sort. I did talk about this in a number of other contexts and I was told that we didn't have any insurance or any sort of cover; we had so much money in the government that if anything went wrong we would pay for it. That's how it worked, so you were alright, Steve. Stop worrying.

¹⁵³ ISO 9000 is a series of standards drawn up by the International Organization for Standardization addressing quality management and assurance.

Sutherland: Well, I know Denis Rothwell, who was head of department, did worry about that at the time, but I was assured by him and the electronics team that they had space technology triple redundancy built into their logic, so absolutely nothing could go wrong.

Marsh: We didn't say absolutely nothing could go wrong.

Sutherland: Oh, well, that's what I thought at the time and it seemed reasonable. One more anecdote from me is on the pump that Geof and Steve were making part-time.¹⁵⁴ The old thing about if you don't sleep at night you won't grow, it might be right because children naturally, when they sleep, produce growth hormone releasing hormone (GHRH) in little pulses every four hours. We were also asked by Charles Brook¹⁵⁵ at one of the London hospitals, who was working on growth retardation in children, whether we could produce one of our luteinizing hormone releasing hormone (LHRH) pumps that we used for infertility to work with children with growth problems. And Geof and Steve produced one that gave a little pulsatile infusion of GHRH every four hours and they put these pumps on these children and they started growing. It was amazing.

White: I just want to add that the work was not all infusers in the Engineering Department. We did an awful lot of stuff in the other labs. I certainly supported the biophysics lab quite a bit and my MSc project came out of that as well. Another thing I wanted to say about the engineers and the scientists and natural politics between the groups, there's a size thing. You've got many scientists and relatively few engineers, and the scientists are coming in every day wanting stuff. But the engineers need to have a reasonable kernel there and they need to have their own projects as well and that's why the infuser, and the growth hormone pump, the fertility pumps, my MSc project, that was all very useful for skill development; and, for example, Andrew did his PhD at the same time. Geof and I left the NIMR and went into blood glucose sensor production – well, Geof did and I supported him as an external consultant. So the Engineering Department really needs to be a kernel, it needs to be big enough to fight off the scientists. Because it is a natural thing: you

¹⁵⁴ See pages 69–70.

¹⁵⁵ Professor Charles Brook was Consultant Paediatrician at the Middlesex Hospital (1974–2000) and Professor of Paediatric Endocrinology at UCL (1989–2000; emeritus from 2000); he was Director of the London Centre of Paediatric Endocrinology at the Middlesex and Great Ormond Street Hospitals (1994–2000).



Figure 34: Mr John Sawkins in the workshop c.2009

come in and you say you want something and the scientists are in control, and the politics, the voting, the voting is much higher on the scientist side so you need a reasonable kernel there to develop the engineering skills within the NIMR.

Sawkins: Just to add to Steve's point, I was in the first room in Ronan Cottage to which scientists came – they were supposed to come to me for repairs, fuses, nuts, and bolts. But if I didn't happen to be there, then all the lads were viewed in exactly the same light as me, as if they were just repair men. The scientists would just waft in and expect the engineers to provide them with fuses, nuts and bolts, and minor repairs. You're absolutely right, Steve.

Marsh: I think the point Steve's making is that if you get below a critical mass in electronics, it's the same anywhere else, it doesn't work any more. And unfortunately we got below that critical mass. You need to have people to talk to about your ideas. We need to sit in that kitchen and talk about how we're going to solve problems and that makes all the difference. If there's only one of you it's very, very difficult. Some people can do it, like John Lewin, but most of us like to work in a group and talk about things and say what a dopey idea it is and it won't work for this, that, and the other, and save a lot of time like that. It's backup too, you can't get something to work but somebody else

can come in and say: ‘Ah, have you looked at that?’ And you think, ‘God, why haven’t I looked at that?’ That makes all the difference, and unfortunately that went.

Tansey: How was the critical mass created, Jon? How and when? Who was pushing for the creation of the critical mass?

Marsh: I don’t know, I suppose I was. But I don’t know.

Tansey: How many were there when you joined in 1960?

Marsh: Oh, two – John Lewin and myself. But we built it up to about eight, and that was at the top and then it all petered out. It petered out with all these things that Heinz has spoken about – the money, demands about accountability, not being allowed to do things, getting rid of the scientific staff, that was another problem in engineering, and it all went. The other problem was that an awful lot of the things that we did, and I think I’ve said this to you before, were commercially available. So for us to be able to tackle something that was needed was becoming technically more and more difficult.

Tansey: And the science itself was changing a great deal, it was becoming more molecular, wasn’t it?

Marsh: That’s exactly right. I hated all that. All this molecular biology coming in and everybody doing the same thing. One piece of kit in every lab. Ridiculous. The place is supposed to be multidisciplinary and, you know, they’d be doing the same thing everywhere. I think it was very sad.

Tansey: So we seem to be now in the 1980s and the time of trouble. We had a lot of euphoria in the 1960s and 1970s. What was the situation? Some of you had been there for 20 years or so. What were you thinking? Were you so conscious at the time that things were changing, as technical staff? The mood of the Institute was changing?

Higgins: I can tell you one thing that fits in with a number of things that we’ve already spoken about and we talked this morning, about moving on from IBM machines to BBC micros and then PCs.¹⁵⁶ And it was mentioned before about failures and, when I first came to the MRC as a student, I worked with Martin King and Mike Anson on building a big analog to digital capture and playback

¹⁵⁶ See pages 58–9.

system.¹⁵⁷ We built the prototype; I think they got it working just after we went back to university, which was a bit of a shame, but when I came back to the MRC two years later, to work permanently, effectively the board had been shrunk down to fit inside a PC, so it could work in tandem with the PC. But we had a lot of trouble getting it to work reliably, so I wrote a lot of software to drive it and that side of it all worked fine, but we were using it with Mike Ferenczi's group and we were getting very noisy results.¹⁵⁸ We kept looking at it and looking at it and eventually we found the reason why and there were some design errors in the electronics. But unfortunately time had passed us by to some extent, because what we found was that the same thing that we were developing was commercially available. I have no idea what was spent going into that but probably quite a lot of money. But we could basically buy a commercial equivalent which had more capability, albeit generic software, for about £500, I think. In the end, unfortunately we had to bin what we were doing but, yes, we learned a lot of lessons on the way, I suppose.

Tansey: There have been one or two specific things that have been mentioned, one for example the apnoea alarm.¹⁵⁹ What was that?

Marsh: We're going back to the late 1960s. I'm working with John Lewin upstairs and he's gone off to talk to somebody in a hospital, I thought it was to do with the planimeter that he was trying to sort out results. He's walking through the premature baby unit and one of the babies has an apnoea attack – when a baby stops breathing; more often than not they start breathing again. What had happened before was that they would start breathing again on their own and no one would know it had happened; or if a nurse spotted that a baby had stopped breathing, a

¹⁵⁷ Mr Russell Higgins wrote: 'Martin King was a Senior Research Officer in the Electronics section based in Ronan Cottage. Mike Anson was an electrical engineer and biophysicist who worked in very close collaboration with the Electronics team in Ronan Cottage.' He added: 'The analog to digital capture and playback system was designed to capture audio signals from experiments into computer memory. The intention was to then have the capability to replay the sounds digitally along with the ability to display and manipulate the sound information with a host computer (initially a BBC micro but subsequently an IBM PC).' Email to Ms Caroline Overy, 21 September 2015.

¹⁵⁸ Mike Ferenczi was on the scientific staff of the NIMR from 1983 to 2001, after which he was Professor of Physiological Sciences at Imperial College London until 2012. Mr Russell Higgins wrote: 'Regarding the noisy results – we had difficulty in capturing audio signals consistently and reliably. I subsequently found a design issue on the circuit board that had been designed for the project.' Email to Ms Caroline Overy, 21 September 2015.

¹⁵⁹ See page 70.

stimulation, a little bit of a tickle of the foot or something, would start the baby breathing again – these are premature babies I’m talking about – and then the baby would be fine. The snag with this was that, if the baby had stopped breathing for more than a minute or two, it was possible that some permanent brain damage had occurred, which wouldn’t be apparent until the child grew up. It was an awful thing. So John thought: ‘This is a big problem; I’d like to help with this; what can I do about it?’ He felt what was needed was a system which attached to the child. He thought: ‘What we want for this is a non-invasive sensor that we can detect whether the child has stopped breathing. How am I going to do it?’

He was sitting at home one day watching his children play on a lilo and he could see that as they moved around on the lilo the different compartments were squashed and he thought: ‘Ah, if we could have a manifold and we could have air going from one compartment to another via this manifold, we could detect the movement of this air and then we could use that detector to send a signal to an electronic circuit, and that’s the way to do it.’ And that’s what he did.¹⁶⁰ That was eventually marketed out by a couple of companies, MBI was one, I think, Chemical Electronics, a company in Durham, was another one, and these were put into hospitals all over the place. There were two basic problems we had with it: one was the alignment of the sensor. The sensor was a thermistor, a thermistor is a resistor that gets warm and as you pass air over it, it cools down and changes resistance, you can detect that and that detection was used to cancel an alarm signal. So all the time you’ve got an alarm going off and it’s cancelled, cancelled, cancelled, cancelled, and if it’s not cancelled then it goes off and then the nurse comes along. With the alignment of those in the manifold, these bags had six or seven compartments and you had to align this thing and I had to do that. It was quite tricky to do. The other thing was the mattresses used to leak. That was another practical problem. We eventually solved it but it was, I think, an important thing.

Tansey: It’s interesting talking about what was going on at Mill Hill and the things we’ve been talking about, the bespoke things, and then you can almost buy things off the shelf. There’s an idea, you work on it, and you get a company to manufacture it. To come back to the point that Steve made, where is the liability in this?

Marsh: I think in those days people weren’t getting worked up about liability. If we were helping some babies to succeed, there was no liability involved in that. It was better than things were before. So we didn’t consider it.

¹⁶⁰ Lewin (1969).

Tansey: But how was it negotiated, Jon? How did you get a company to then make it and market it?

Marsh: Right, I'll tell you how that worked. We used to go every year to a thing called the Physics Exhibition – it's quite often held at Alexandra Palace – where we would have a bench and we would demo what we'd done during the year which we thought was good. We went along one year, I can remember the year, we had the planimeter there, and we were showing people the planimeter saying, 'this is brilliant.' The other thing John had was the apnoea alarm. And George Pearson from this company called Chemical Electronics was there and he said: 'This looks interesting. I'd like to manufacture it. Would that be alright?' And that's how it went.

Tansey: And you just did that?

Marsh: No, it was a bit more complicated than that. I'm doing the electronics and the technology, I'm not organizing who is going to get this work. So somewhere Jack Perkins or the director would be involved, I don't know.¹⁶¹

White: Just to say that there weren't many regulations at that time so you could say we weren't liable with the insulin infuser. There weren't the same regulations around. Now you'd be very liable. If you went into an insulin infuser project these days you would need a lot of money, you probably wouldn't be able to do it at the Institute.

Tansey: I'm just wondering whether it explains a comment that Ian [Sutherland] made earlier about Arnold Burgen saying: 'We're doing fundamental research, not clinical research' because of liability or something like that?¹⁶²

White: Well, there weren't the regulations then that allowed that sort of work. I remember going down to the Samaritan Hospital, Ian [Sutherland] got me into that, again. That was a thermistor-based instrument to measure blood flow, it was heated with a current passing through it and it was used to monitor uterine blood flow. And I went down to the operating theatres and I measured uterine blood flow on the patients while they were on the operating table.

Marsh: I'll just quickly say that I'm quite sure that liability was not the reason we stopped doing it. The reason we stopped doing it is because it's not what we were supposed to be doing and it was frowned upon by the powers that be – we should have been making test tube racks, and that was really the reason.

¹⁶¹ Jack Perkins was head of the electronics section of the Department of Engineering.

¹⁶² See page 69.

Sawkins: Tilli, just going to those uterine detectors. They were given to me to make up and how I made them actually was largely invention in my own head. But what I think we're looking at here, in general terms is, for example, the monitor that's in front of you there: the density of the technology in that monitor is one of the things that actually makes it impossible for me to do what I used to do. Whereas a power supply was something we could actually look at and probably understand in the days you developed the MBI power supply, a power supply nowadays, apart from being electronic, actually some guy has written a piece of software and you can't touch that. It's very cheap to buy. That's what brought about my decline.

Mathison: I'm not an expert in these matters but I think at the research and development stage there wouldn't be any comeback. I think the responsibility, legal responsibility, starts at the point when these instruments are actually being sold and put into the field. So I don't think there would be any comeback.

Tansey: Can I follow up on something Jon has just said – stopping doing these sorts of things to do what you were supposed to be doing. So can we discuss what you were supposed to be doing? In the 1970s and 1980s, what were you supposed to be doing, and not just in Engineering, but all of you? Engineering can start.

Marsh: Well, we were supposed to be doing what people who walked in the door asked us to do. We weren't supposed to be doing what John Lewin had spotted in some hospital. We particularly weren't supposed to be doing things for outside the Institute. I think that was a general feeling. Although we did do things and later on, it was much later we did the infuser and that was an NIH contract eventually and it was all approved. But you could tell that the scientific staff at the Institute felt: 'Yes, it's all very well, but what has it got to do with us?' I think they had Heads of Divisions meetings – we were a department not a division, although Denis Rothwell did go to those and subsequently when I became head of department I sort of half went, but I was never a proper member, and we weren't supposed to be doing that sort of thing. They didn't want us to do that. They wanted us to be down there being able to do whatever they wanted, when they wanted it. That doesn't always work to give you fantastic breakthroughs.¹⁶³

¹⁶³ Professor Ian Sutherland wrote: 'Until I left, we had scientific staff in Engineering and our research always had a five-year forward plan that had to be approved and occasionally we would have an MRC visit that would review this research and assess progress. There was also (as Jon said) the random element of service and who came through the door and this could often lead to new science.' Email to Ms Caroline Overy, 24 February 2016.

de Rossi: You had to be a service section. Jon, didn't you?

Tansey: Did that apply to people in divisions as well, in Immunology, in Nutrition, in Physiology?

de Rossi: No, you definitely weren't a service section. Each division ran their division as they wanted to, it was very individualistic in that sense of the word, and you would cooperate a lot with other divisions as you may be doing similar work or coming across the same problems. If you could discuss it with other members of staff, this could be a great help.

Marsh: I think that's right. Don't make a mistake about this – scientific divisions were completely different to Engineering. This is demonstrated by what happened at the end of my time there. They decided that Engineering could be run by the Works and Maintenance bloke – that just shows you the thinking behind it. The NIMR, like the MRC, had subcontracted out all this – they had been told by the government to get rid of the internal plumbers, fitters, painters, all of that had to go, and they got some company in to do it all. This company came in with a bloke who ran a similar set up there at Fords, and the powers that be said: 'Oh, he can run Engineering, it's only engineering – people with spanners who go around and mend a pipe.' I think it's still the same – it's run by him now. It's terrible; I don't think they understand the philosophy or the culture behind it.

Sawkins: Just to add to that, apart from the lads in Mechanical Engineering who are still doing fine work actually, the only guy who is doing developmental work now doesn't actually work for Engineering any more. He actually works for Neurophysiology, he just happens to be in my rooms and he's doing some wonderful developmental stuff for them. But it's a way of fudging the issue.

Marsh: That's the way to do it. I must just say that's exactly right. The electronics is going on but it's not in Engineering, and that's how you get away with it. If it's in the scientific divisions, 'brilliant, it's science'; if it's in Engineering, 'oh, it's works and maintenance, you know.' It's awful and I'm not sure that that message has got through to the Crick.

Pinder: I think part of the problem is actually in the word 'engineering'. As a member of the Institute of Engineering and Technology there is always a debate going on about the status of engineers. In this country the status of engineers is not what it is in Germany. So that's one problem. I've got a couple of questions. First of all we've talked about the demise of Engineering over the years and

the loss of its scientific staff. Ian Sutherland, Mike Anson, John Sharpe, Denis Rothwell, and I were scientists. We were scientists in the same way that other people were, yet nevertheless it was not regarded as a scientific division. So how did that arise? We know how it faded out but how did it arise? The other question I want to put is: if Engineering hadn't been put under the cosh, what would we be doing today? I think the answer is there is still a lot that could be done. I actually disagree with John Sawkins when he said: 'Look at that monitor, it's full of stuff we couldn't work on.'¹⁶⁴ The point is we wouldn't be working on that monitor, it's what we would be using that monitor to do.

Sawkins: Yes, exactly.

Tansey: So how about answering your first question yourself, Andrew? How did this come about?

Pinder: Well, I don't know because I came in to a scientific department so I don't know the answer to that one.

Marsh: I think it was Medawar. Before Medawar we did have Mr Lister,¹⁶⁵ who was head of Engineering, and we had Jack Perkins, who was running Computing – they were technical departments; but it was in Medawar's time that he appointed some scientists and I think that's what did it. I think he was a right thinking sort of guy and all the subsequent ones are the old school and think: 'What's this? What are these scientists doing in Engineering? They shouldn't be there. They should be in scientific departments doing science not faffing around mending pipes. What's going on?' So I think that's how it was.

Tansey: Many of the scientists would have come from the tradition of making their own equipment anyway. So it seems as if there's some kind of overlap and distinction here that I can't quite figure out – a lot of physiologists, for example, always made their own equipment.¹⁶⁶

Marsh: It's fine to be an engineer if you're in a scientific department. We got another chap who was in Physiology. Physiology was full of good engineers,

¹⁶⁴ See page 94.

¹⁶⁵ W C (Bill) Lister was Head of the Instruments Division (later Engineering) from 1953 until his retirement in 1970.

¹⁶⁶ See note 87. See also Dr Anthony Travis' discussion of James and Martin working on a gas density balance: 'This was quickly put together, first as a glass model. According to James, Martin was an expert at working with glass, so probably technical staff were not involved at this early stage.' Appendix 6, pages 162–3.



Figure 35: Mr Ian Mathison and Dr Howard Rogers in the Division of Microbiology c.1969

and we had a couple of people down there; they were engineers basically but they worked in physiology – no problem at all, because they’re working doing science. It’s snobbery, I’m afraid. That’s the problem.

Mathison: When I was working firstly in Bacterial Chemistry – which then changed to Bacterial Physiology and then to Microbiology to reflect the slight difference and change in research – we worked mainly on antibiotic resistance.

One of my jobs was preparing cell walls and analysing them. And in preparing cell walls we had to disrupt the cells, usually *Staphylococcus aureus*, which we treated with respect. There were various methods of breaking them up and we relied very heavily on the Engineering Department to make the apparatus. There was a Hughes Press made from stainless steel with a plunger on top and we used to go down to the Engineering workshop and use their fly press to push the plunger down and the suspension of bacteria were forced through a very narrow gap. Later on we developed methods of disintegration using Ballotini glass beads. A lot of this apparatus was made in the workshop, there was nothing commercially available at that stage, which worked efficiently but later on this did become available.¹⁶⁷ I’d like to say the culmination of each stage of our work was the production of a paper, and there’s the difference I think between our work and the service departments.

¹⁶⁷ For further discussion of the apparatus, see Appendix 7.

Marsh: The Hughes Press, I'm afraid, is not a good example because so very often exactly what Ian is saying happened. Somebody would read his paper and they would see some piece of kit in this paper and say: 'We want one of those, it's not commercially available.' The Hughes Press certainly wasn't developed at the Institute but we made one because we had the skills downstairs to do it.¹⁶⁸ These people were very skilled craftsmen and they could make this thing and it would do the job. That's one of the reasons why Engineering was there because early on there weren't scientific manufacturers making this kit off-the-shelf to do these things that people wanted to do, even though they'd been published in papers. So what would happen is they'd come down with a scientific paper and say: 'This is what we want; we want one of these; will you make one?' And that's what we did.

Tansey: Papers are one thing, another thing are patents. Did you ever get patents?

Chambers: Regarding patenting, I think somehow the ideas went out through the National Research Development Corporation (NRDC). Certainly the Mill Hill Infuser and the various patents that that generated went out through NRDC and then that got licensed out to Novo Nordisk and I think NRDC was paid a licence from that. Then I think we actually got a small amount of money from that. The people who were on the patents, I think it was sort of less than £100 but at least you got something out of it, which was amazing really.

Pinder: NRDC, I think, was set up just before Thatcher.¹⁶⁹ Basically, any innovation that came out of a government institute or whatever had to go through them. They were a bunch of civil servants so you can imagine what I'm about to say. I was involved with them because I was working on what was called the clinical tympanometer, which was an instrument for measuring tiny vibrations of the human ear. I won't bother to go into why we were doing it, but it was felt it was a useful diagnostic tool – actually remarkably clinical, again,

¹⁶⁸ Mr Ian Mathison wrote: 'The reason for asking the engineers to make apparatus or instruments which were commercially available, was to improve the design or adapt them to suit our own requirements.' Note on draft transcript, 18 November 2015.

¹⁶⁹ Dr Andrew Pinder wrote: 'The National Research Development Corporation was set up by the Attlee Government in 1948 (originally to commercially exploit developments during the Second World War). In 1981 it merged with the National Enterprise Board (a Wilson initiative to extend the public ownership of industry) to form the British Technology Group. My comments span the end of the NRDC era and the beginning of the BTG.' Note on draft transcript, 2 October 2014.

despite the fact that there was this bias against clinical work.¹⁷⁰ The whole thing had to be done through NRDC. We delivered the instrument, the instrument did its job, but I have to say I think we felt we were let down from the NRDC point of view. They were, after all, civil servants, they weren't venture capitalists, they weren't used to taking risks and they were also generalists, so the guy we were dealing with was dealing with lots of other things as well but had no specific expertise in the field. They'd supposedly go out and try and get industry interested, so really it was a middle man, which wasn't helpful. Even if, at the end of the day, they were helpful I think the deal was something like the Institute would get 0.1 per cent of the 0.1 per cent that the NRDC got, so actually there really wasn't a big incentive to do it.

de Rossi: I think one of the things in the 1980s was that the money was much tighter – budgets were much harder and you had to budget every year for exactly what you thought you needed for the year, which is quite hard sometimes, particularly if you've a lot of visiting workers, which certainly we had when I ran Parasitology. I suppose half the workers were coming from all parts of the world to work in the division and they would sometimes bring money with them to help fund their research. We used to have terrible trouble because the office thought it was their money. I said: 'No, it's been brought in for this specific person and they should spend that money and we will order things especially for them as they need it.' But it was extremely hard and it got harder, I think, as the 1980s went on. Then at the end of the financial year there would be a mad spend, because if the office had monies to spare this was relocated to the divisions; they could buy this, that, and the other, all in a big rush because if you didn't spend the money in that financial year it went back to the MRC. So it was a big change in thinking.

Marsh: I think that's right. I think it was during Margaret Thatcher's time – she decided that we needed to be more efficient. We had the Rayner Review and had these efficiency experts in who looked at what we did and how we did it, and they decided that they'd make these recommendations.¹⁷¹ One of the recommendations they made was that we had to start charging for what we'd done. Before that we would do whatever the departments wanted and we

¹⁷⁰ Tympanometric Apparatus. UK Patent No. 8215547 (provisional 8117847). This is referred to in Pinder and Palmer (1982); Pinder and Palmer (1983). Information supplied by Dr Andrew Pinder.

¹⁷¹ In 1979 Sir Derek Rayner was asked by Margaret Thatcher to carry out a review into the efficiency of the civil service. The papers and reports of the Rayner Review are available at the National Archives (FD 7/1940 and FD 7/1941).

didn't charge for anything. They said: 'You've got to start charging out the cost for the bits and the time that you've taken to do it.' I was horrified because I thought if we start charging out for the time that we take to do anything we'd never do anything ever again, because the time is a hell of a lot of money; we're talking about the salaries of two or three people. So it was my job to deal with this and I managed to resist it in the end – I managed to come to a compromise whereby we would charge out for the parts but we would only inform them of how long it was going to take but we wouldn't actually charge them for it. I thought: 'We can get away with this' and, of course, the scientific staff didn't care two hoots really how long it took. I think the idea was that, in their thinking, you need to make people realise how much of a demand they're making on you. This costs real money. And yes, I'm sure that's all jolly good, but actually in science they don't care about that and I don't blame them. You know either you want science done and you're going to pay for it and you're going to let people get on and do it, or you don't want it. If you want to save money then it's easy enough, you just shut the place down. They never really thought that through.

Mathison: Yes, around this time I remember the Manpower Services Group came to the Institute to investigate our stores. Leading this small group of people was a developmental biologist well known to Mike Gaze, head of the division, and Vicky Stirling. And they threw their arms up in horror and said: 'What does a developmental biologist who's been doing research all the time know about the running of the stores in the Institute?' A few years later I met a friend of my wife's who was working for the Manpower Services Group and she said: 'Well, it's rather like becoming an MP or such. It's quite a good idea, say, being Minister of Health or whatever, not to know much about it because then you're not prejudiced when you go into the situation and make your report.' So you could see that we were beginning to be changed at that stage. They dropped two from the staff in the stores, and recommended that certain things were supplied without charge. I don't know whether you remember that, Rosemary?

de Rossi: Yes, I remember the staff going and everything changing in the stores, and it was much harder work to actually get anything out of them at that stage because they were frightened about letting anything go.

Mathison: Yes, there were a number of things like Wellington boots and other things, which were considered to be costing under £2 or something, including rulers, rubbers, and notepads. They said: 'It's much quicker and will cost less

to make no charge on those items.’ They didn’t reckon for people going down there and helping themselves and unfortunately there are a few people like that and that method had to be changed soon after that.

Marsh: It’s your garage stock, is it, Ian?

Mathison: No, it’s in your garage.¹⁷²

Morgan: I think it’s an opportune moment to say a little about the work that we did in leprosy where we dealt with both leprosy and TB, and various other mycobacteria.¹⁷³ We were a World Health Organization (WHO) training and reference lab, and one of the things that cropped up not long after I’d started in 1974, when the routine medication for leprosy was a drug called Dapsone, was that they were just beginning to find Dapsone resistance among some of the patients.¹⁷⁴ WHO put together a programme where there were two or three participating leprosy centres in India and Africa. They would send us samples and these we inoculated into mouse footpads and then fed the mice on different regimes of drugs, mixed into their diet. We then watched the mice and after a period they were killed. We had to harvest the foot pads and count the bacilli – it’s a bit like Jon Marsh counting all his different organisms – a deadly job.¹⁷⁵ My eyes would never stay focused on the microscope; they always went in and out, so I couldn’t do it, hurray! But leprosy comes in different forms and we were able to get regimes of drugs and medication suitable for each form of leprosy. This became known as multidrug therapy and is what is now used throughout the world for different types of leprosy.¹⁷⁶

¹⁷² Mr Jon Marsh wrote: ‘This is a joke about purloining items from the NIMR, which, of course, we would not do. Ian had a large number of items of redundant scientific equipment and so did John Sawkins and I. These were usually rescued from the dump. We have now donated most of them for the proposed exhibition in the Crick foyer (if it ever happens). In the meantime it has all been photographed and catalogued.’ Email to Ms Caroline Overy, 26 July 2015. Mr Ian Mathison added that the equipment had been offered to schools but they weren’t interested and the remaining items were duplicate items from the museum, and unwanted stock. It includes, among many items, early pipettes (forerunners of the Gilson pipettes used today), Bunsens, balances, glassware, and a multiple magnetic stirrer. Telephone conversation with Mr Adam Wilkinson, 25 August 2015.

¹⁷³ For a discussion of leprosy and tuberculosis research at the NIMR, see Clayton and NIMR staff (2014), Chapter 17, pages 268–84.

¹⁷⁴ See, for example, Pearson, Rees, and Waters (1975).

¹⁷⁵ See page 33.

¹⁷⁶ For the development of multidrug therapy in leprosy, see, for example, Sansarricq (2004).

So we put some good work in and it's really paid off and has helped to reduce the number of leprosy patients and to cure them, and also to get people educated and come forward and have treatment. So we really feel that we have contributed quite a lot. Our efforts at producing a vaccine weren't quite so successful, although we did find that two BCG vaccinations were more efficient than one at preventing leprosy, and were actually better than the product that we had produced from armadillos.¹⁷⁷

Tansey: We haven't really discussed the role of the NIMR in WHO, for example, or in international medicine, whether it's the Influenza Centre or going back to International Biological Standards, which came from Hampstead.¹⁷⁸

Travis: Can I make a comment. After the Second World War a lot of developments were based on surplus instrumentation and components. I know, for example, George Porter became Sir George Porter in part because of the skilful way in which he successfully used surplus war equipment in his scientific studies.¹⁷⁹ I'd like to hear a little bit about surplus equipment, whether it's immediately after the Second World War or during the 1950s or 1960s, because I think a lot of very interesting work, based on my discussions with Jon, was done at Mill Hill, and it will be nice to know a little bit about such work and the people involved. Also, Peter Morris reminded me of another topic: if anybody did any work on staining techniques at Mill Hill at any stage, and developments in staining techniques, for example, in the sort of laboratory situation we've just heard about. If anybody has any comments it would be very interesting to hear them.

Marsh: Well, I don't know if you want to know this or not but clearly Tony wants me to talk about it. I know what he's talking about. When I started

¹⁷⁷ Research for a leprosy vaccine at the NIMR was part of the WHO's IMMLEP (Immunology of Leprosy) programme. Nine-banded armadillos (*Dasypus novemcinctus*) are the only other animal host susceptible to leprosy, and animals were sent to the NIMR *M. leprae* Bank to develop a vaccine. See, for example, Smelt, Liew, and Rees (1978).

¹⁷⁸ See pages 21 and 42.

¹⁷⁹ George Porter, Lord Porter of Luddenham (1920–2002), was a British chemist, whose research focused on the development of flash photolysis, originally using army searchlights and navy surplus for his experiments. In 1967, he shared the Nobel Prize for Chemistry with Manfred Eigen and Ronald Norrish, 'for their studies of extremely fast chemical reactions, effected by disturbing the equilibrium by means of very short pulses of energy'. See Fleming and Phillips (2004).

upstairs with Electronics, getting components was really quite tricky. First of all there were two companies that supplied electronics mainly to people like us – they were Radiospares and Farnell, and they were hardly in existence at that stage.¹⁸⁰ The Radiospares catalogue was a little flimsy paper thing of about 20 pages. Not only that, there wasn't any money to buy components, so an awful lot of the stuff that we used was second-hand. There were two ways that we got this: the first way was that we had some old missile circuit boards. I was told they were out of Blue Streak, when Blue Streak had been cancelled, and they were stored in a cupboard down the end of the corridor.¹⁸¹ I was told: 'If you want any transistors, Jon, go and take them out of that old board.' Pip Piper did have some new transistors in the white cupboard, which was locked and he had the key, and he wouldn't give me the new transistors for doing lash ups and test circuits in case I blew them out. The other way we got stuff was to go down to Lisle Street in London and get a lot of old ex-government crap that was for sale down there, like odd transformers and various things.¹⁸² A couple of times I had to go up there for John Lewin with a list of stuff to get; and there was Proops and people like that up there where you could get things from.¹⁸³ So when I'd actually developed a circuit and got it working and it was not going to blow up, I might if I was lucky, get a brand new BC109, or even earlier than that, the old germanium transistors. Another example of that is we wanted an optical opto transistor. Well, we couldn't afford to buy one of those. I had to scrape the black paint off an ordinary germanium transistor to make it into an optical transistor

¹⁸⁰ Radiospares Limited was established in 1937 in north-west London by J H Waring and P M Sebestyen to supply radio repair shops with spare parts; in 1954 they also began selling electronic components. Today it is a global distributor of electronics and maintenance products. A C Farnell Limited was founded in Leeds in 1939 by Alan Farnell and Arthur Woffenden to sell radio parts. In the 1940s it switched to the wholesale market. Today Farnell is one of the leading distributors of electronic components, electrical parts, and industrial products.

¹⁸¹ Blue Streak was a British medium-range ballistic missile developed in the 1950s as a nuclear deterrent. The project was abandoned in 1960.

¹⁸² After the Second World War, Lisle Street was a focus for stores selling army surplus electronics. For an example of use of these surplus stores by technicians to source material to build their own equipment see Tansey E M (Tilli). 'Building Henrietta: DIY electrophysiology in the 1950s' online at www.histmodbiomed.org/blog/building-henrietta-diy-electrophysiology-1950s (accessed 20 May 2015).

¹⁸³ Proops was a family business that opened in 1948 on Tottenham Court Road, selling war surplus items, in particular medical equipment and technical items.

so we could get an optical transistor.¹⁸⁴ So it was pretty dire. I think that's what you wanted to hear, Tony, wasn't it?

Travis: Let's go back in time to surplus Second World War equipment in the late 1950s, early 1960s. I remember when I was about 16 years old, going with my brother, who would have been 13, a budding radio ham – he had just moved up from making a crystal set to a one valve radio – to Wembley High Road. We were living in Wembley at the time, and I helped him carry home, about 3 miles, an army surplus tank model 119, Mk III radio that he modified for receiving amateur bands. I was quite amazed at what was available. I used to go with my brother to buy components in town, and, as you reminded me, people used to trip up over all the stuff lying around in Proops; there was just so much. I don't know where they were based. Lisle Street?

Marsh: It was in Lisle Street. There was more than Proops, I've forgotten the names of the other ones, but they all had this army surplus equipment, electronic equipment, and you could buy a whole load of stuff. We had a thing that Trevor [Holman] had – it was a charger for charging the Lancaster bomber batteries, which we used to charge the batteries in Ronan Cottage. In fact, I think that was there till I retired in 2012, and apparently it's still there in Ronan Cottage charging batteries. So it charged batteries on a Lancaster bomber and it's charging batteries now.

Morgan: Question for Jon. Did you do all this on petty cash or did you somehow manage official orders? The latter seems unlikely.

Marsh: You're absolutely right, I think probably on petty cash, I don't remember, Hilary, but I do remember, going back to what Heinz was saying, about order numbers – that was the secret of getting stuff. We had an office, the Supplies Office, which would order stuff from outside. You couldn't write out an order for something and expect them to get what you wanted because the things that we wanted were technically too specific. The best way of getting it was to phone up the company and say: 'Look, I want a plug with slightly more gain and a little bit smaller' or whatever it happened to be. You couldn't really explain all

¹⁸⁴ Mr Jon Marsh wrote: 'The original transistors were made from germanium, then later they used silicon. The old germanium OC77 transistor (one of the first) was inside a clear plastic casting painted black. There are three wires to a transistor, one, called the "base" is where the transistor is controlled from. If you scraped off the black paint, then the control could be by light, as shining light onto the transistor had the same effect as a signal on the base. So it could be used as a light measuring device in electronic circuits.' Email to Ms Caroline Overy, 26 July 2015.

this so what I eventually used to do was to phone up the Supplies Officer, and I got quite friendly with him in the end, so I could get anything I wanted. I'd say: 'Give me an order number' and I would get on to whoever it was and get a load of stuff. Usually they'd say, 'Don't spend more than twenty quid' or whatever it happened to be. The other thing that happened was if I put down: 'Get a particular transistor on the chit' they would say: 'Well, where do you want me to get it from? We've got preferred suppliers.' This was the other snag, 'preferred suppliers' – what a nightmare they were because they were twice the price of the people I could get stuff from. I said: 'I'm not going to this preferred supplier because they're charging too much. I can get it from so and so.' We made relationships with the suppliers. In fact, we made such a good relationship with the Farnell chap we got taken up to Leeds once or twice on a day out, to go round the factory or warehouse up there.

Mathison: I have a brother-in-law, John, who has a learning disability but he's very good at dismantling equipment. And quite often with the changes that took place at the Institute, 'jumble sales' were organized and all unwanted equipment was put on trollies, taken down to the foyer, and after 4 o'clock if it was still there it went down to the scrap area and was taken away by the scrap metal man who was paid to come. I used to take the stuff across to John, who lived in Stanmore at that stage, and, under the supervision of his father, who was a retired engineer, he would take all this equipment apart. Relays, micro switches, and, in the old days, neon lights, and any other interesting pieces of equipment, which I thought were useful, were put in a box and I'd bring them back to Trevor Holman who added them to his stock. When I asked the obvious question: 'Is there anybody in the Institute willing to take these bits apart here and recycle the equipment to get useful stuff out?' always the answer was: 'No, we haven't got the time, we haven't got the labour.' John separated the brass, copper, aluminium, and lead, and he made a bit of pocket money from the scrap and I returned useful items to the Institute.

Sawkins: Something you might follow up if you do this in other institutions, Ian's just mentioned something which has been banned now, which are jumble sales. In fact, most likely the reason that we have the bits that you may or may not want to keep in your collection is basically because people used to go to the jumble sales and it was a free for all. If you fancied something you just took it. Now none of that is allowed because of Health and Safety and various other things. For instance, I regularly pass a piece of teak, which is on my parents' old house, which is beautifully carved out and is emblazoned with the number 106

on it. Thankfully that's because the MRC in their wisdom threw out all the teak benches and I can tell you now – that teak has gone virtually worldwide now, in all sorts of people's homes.

Mathison: Talking about old equipment, there was a TSR2, wasn't there?¹⁸⁵ Do you remember that? Wasn't it a trial plane? Also Concorde test equipment, which my father in law managed to get, and I'll never forget three generations of my wife's family, the Whites, all sitting in Stanmore gradually dismantling all this equipment. Previously a lorry had unloaded it all. And there again I found useful items and delivered them to the Institute. This was about early 1970s, I should say.

Marsh: Just going back to 1960 then. When I first arrived at the Institute I didn't know anything about research at all and I went to work for Neil Brown as a technician.¹⁸⁶ One of the things that happened then, which gradually petered out, was that we went round the other departments now and again to be trained up in the techniques that we might want to use. We were trained by Doug Short about animal handling;¹⁸⁷ we had a session in the general purpose workshop to be told how to use, for example, the drills and the lathes and milling machines; and we went with Den Busby in Virology to see how they used to infect eggs with the flu virus and all that sort of jazz.¹⁸⁸ I think that was terrifically useful in terms of getting people to be proper hands-on technicians. We could turn our skills to pretty well whatever we were asked to do. I'm sure that doesn't happen now. It's gradually petered out.

de Rossi: They did run a scheme for all new entrants at one stage: they used to have to do three months in each department and then decide which department they thought they might like to work in, and if that department had got a vacancy then they were put in at that stage. But that didn't last for very long either. When I was in Biological Standards they did have a system where you worked for three months for each doctor or scientist that was there, so that

¹⁸⁵ The TSR2 was a strike and reconnaissance aircraft developed by the British Aircraft Corporation. The development started in 1957 but was abandoned in 1965: Burke (2010).

¹⁸⁶ For Neil Brown, see page 12.

¹⁸⁷ For Douglas Short, see page 24.

¹⁸⁸ Dennis Busby worked in Virology from 1933, first as a laboratory assistant then technician. He had risen to Principal Technician by the time of his retirement in 1979. For some reminiscences of his work as a technician, see Tansey (2008a). The edited transcript of an interview with Dennis Busby, conducted by Dr Pamela Lear, will be available online at www.histmodbiomed.org.

you could stand in for anybody else if there was a big experiment or somebody didn't turn up because they were ill – you could step in and more or less know what you were doing, which I think was quite a good idea. At the time we used to moan because there were certain people we didn't like working with, shall I put it that way, and because some of the jobs were really boring. For example, depilating 60 guinea pigs on both sides, ready to have their skin injections, which was a very smelly old job – making up the depilating powder and slapping it on and then washing it off and then drying them, then putting them back in their boxes, then taking them along to the lab to be injected, and then afterwards measuring the skin lesions.

Turner: Can I just follow up a little bit on the role of the technician or the type of person that is a technician. I think what Jon and Rosemary have said about the training and the broad range of training, and the people who came in to work for the MRC or whoever, as a technician and that was their role in life, that was their aim. They would go up the ladder, and they would probably eventually become a Head Technician. I think a lot of this has got lost. I think, certainly now, there are very few true technicians. I can relate this to the last 10 to 15 years of my working life when I'd moved on from the Institute but was still working for the MRC and trying to recruit technicians. You could recruit 101 people who had got a science degree but in terms of practical ability they had nothing. Not all of us were made to be technicians, you know. There's a fine line sometimes between a technician and a technical officer and a scientist. There are scientists who are very skilled with their hands, technicians who are very bright on theories, so it's different. But I think the true old-fashioned technician has more or less disappeared in my view.

de Rossi: Yes, I think you needed your head and your hands to be a good technician, you needed both sides of the thinking to be quite honest, because you had to do lots of different jobs and you had to swap and change very quickly if it was needed. In fact the person I used to work for, John Humphrey, used to say I did some of the jobs better than he could do them and if that happened he was quite happy to let me get on and do it.

Marsh: Can I tell a story about starch gels? Well, I'm back in Chemotherapy now, and when we started doing starch gels, I've prepared all this antigen, it has taken weeks to prepare; we've got it all ready and we want to run an electrophoresis separation to separate out the proteins and we need to do it on this starch gel. Starch gel was quite a new thing at the time. There was only

one person at the Institute who could do it, and that was a bloke called Keith Hobbs and he worked in Biological Standards.¹⁸⁹ So Neil (Brown) says: ‘Right, I’ve arranged with Keith that he will run the gel for us, he’ll prepare the gel, we’ve got to go up with the sample and load it onto the gel.’ So up we went, Keith prepared this gel and we loaded it onto the piece of filter paper, popped it into the slot, left it on the electrophoresis power supply for a couple of hours or however long it was, I can’t remember now. Then what you’d do with the starch gels was: you’d use a cheese cutter to slit the gel horizontally; you’d lift off the top half; you’d put that into Amido Black stain; and you would decide where the proteins were. You could then cut them out of the other bit of gel and could use them for whatever you wanted to use them for – usually it was an amino acid electrophoresis or some other thing. Anyway, and this was an example of what you were talking about, Neil wouldn’t let me do this. He said: ‘No, no, I’m going to lift it out, I’m going to lift it out.’ And he lifted it out onto this piece of polythene; that’s how you did it – you slid it onto this piece of polythene and you carried it. Anyway, it fell off the polythene onto the floor and it went to about a million bits. I’d only been there about a year or so and I’d never heard any language like this in my life – bear in mind this did represent a lot of work gone up the Swanee. Ever after that I did all the starch gels. No messing.

Going back to instruments and things, all the technicians were different really, and some of them had more of a technical bent than others in terms of making stuff that you might need around the place. So if you wanted something made, if it was a simple thing, you’d make it yourself, and the facility for that was the general purpose workshop. The general purpose workshop was like a sub-workshop of the Engineering Department and it had two people in it full time and their job was to help you when you walked in through the door. You didn’t need to make an appointment, you just went in with your idea of what you wanted and say, ‘I want to make this’ and they’d say, ‘okay’ and there was a box full of material, Perspex, brass, whatever you wanted, it was all there and you would firstly be helped to make it and later on you could make it yourself. Of course, this had wonderful opportunities for making things that the Institute didn’t want but that you did want, like bits for the car and all this sort of thing, which was brilliant, so we could do all sorts. But the general purpose workshop

¹⁸⁹ Mr Ian Mathison wrote: ‘There were others (me included!) who could prepare starch gels.’ Note on draft transcript, 18 November 2014.

at Mill Hill at that time in the early 1960s was run by Ralph Bower and Alan Delderfield.¹⁹⁰ I remember Ralph telling me one day: ‘You’ve got to be very, very careful, Jon, with chuck keys.’ You must never, ever leave a chuck key in the chuck because if you do and you switch the ‘whatever it is’ on by mistake the chuck key can fly out and it’s very dangerous. It was within about a month of that that Ralph Bower ended up in hospital having had a chuck key come out of a chuck. So after that they fitted these little springs on the chuck key so that you couldn’t actually leave it in, it would pop itself out. The general purpose workshop was a very good skiving place – you could pop down there for quite a long time and meet other people who were similarly passing the time of day. I think Trevor Holman’s workshop was rather a similar one – he had his own room. Before John came along it wasn’t near Electronics, it was somewhere else on the lower ground floor, and he sat in there and you would take something and he would mend it, or you would have a chat about various things and two or three people would turn up and you’d have a general chat which might go on for quite a long time. Excellent. Or you might have to go down to the stores to get something and if you met Bob Conant down at the stores that would be brilliant because Bob Conant would then regale you with the most fantastic stories about all sorts of things.¹⁹¹ It’s such a shame that Bob is dead because he could give you the most wonderful anecdotes about the Institute. He knew a million times more than you, Ian, didn’t he, when it came to anecdotes? [Laughter] I think he did, anyway. A million times more than me.

de Rossi: When I started the technicians had to be able to do everything: pull Pasteur pipettes, make 50 droppers, sharpen needles, sterilize pipettes, sterilize syringes, and a lot of the time was spent on preparative work. You had to just fit those in between the other things you had to do. They were the extras. And then, of course, as these things could be bought, the bills went up considerably.

¹⁹⁰ Mr Jon Marsh wrote: ‘Ralph Bower and Alan Delderfield were at one time in charge of the general purpose workshop; here you could go and construct bespoke lab equipment. If you could do it alone OK, otherwise Ralph Bower and Alan Delderfield would help. Later Ralph Bower was in charge of the mechanical engineering workshop (after Davy retired), and Alan Delderfield went to work in Biological Standards as an engineer; he eventually went to Clare Hall.’ Email to Ms Caroline Overy, 26 July 2015.

¹⁹¹ Mr Jon Marsh wrote: ‘Bob Conant was a senior technician in the Chemistry Division, and a lovely chap. He retired to Pembrokeshire ... he must have left the NIMR almost 50 years ago.’ Email to Ms Caroline Overy, 26 July 2015.

Mathison: There was another character in the Institute called Norman Schunmann, who was the Institute's glass blower.¹⁹² We're going back to when I joined in 1953 and he worked on the lower ground floor, and he was very good – he could do internal seals in condensers and things like this. But it was very difficult to get him to complete a job. You could usually get him to complete your job if you went down there and told him a new joke. After a month he would have a bench clearance and it was very important to go nowhere near because you could hear the crashing of glass. It didn't matter whose work was on his bench left unmended, the whole lot went into the bin and there would be a cloud of broken glass dust in the air, and he'd start all over again.

Morgan: Picking up on what Pete Turner and Rosemary de Rossi were saying about technicians. I think when the majority of us started as technicians we had either O-levels or A-levels and nothing else. As the years went by and people with degrees came along, they were trying to get jobs as technicians, and in the end they were accepted. The problem was for the originals, we weren't very happy with these degree people because they thought cleaning benches was beneath them; emptying waste buckets was beneath them. It caused a bit of stress in some labs at some times. Around about that time I was secretary of the Head Technicians Committee and John Stean was the chairman.¹⁹³ We used to have long heart-to-hearts about what was going to happen to technicians, that they were a dying breed, because they were kind of becoming scientific staff and they had lost their original guise of doing the technical work. Rosemary's right, some technicians had good brains and some scientific staff would have brains but no hands. You had to make one good person out of two, if you like, and when you did that you'd get a super team going. I think the technicians aren't quite lost but they're very, very different to what they used to be.

Mathison: Yes, I'd like to backup what has just been said but in the old days, and I'm starting from 1953, there was a sort of career system, and the junior or student technician, as I was called when I first joined, was expected to do these

¹⁹² Norman Schunmann (b. 1914) started work at the NIMR in 1929 as a lab boy in organic chemistry. He went on to become the general glass blower, repairing and making apparatus for the Institute until his retirement. The edited transcript of an interview with Norman Schunmann, conducted by Dr Pamela Lear, will be available online at www.histmodbiomed.org.

¹⁹³ Mrs Hilary Morgan wrote: 'John Stean worked as a laboratory technician in the Division of Physiology and Pharmacology. He rose through the ranks and was the Divisional Head/Chief Technician. He succeeded Arthur Hemming upon his retirement as the Institute's Principal Technician.' Email to Ms Caroline Overy, 8 July 2015. The edited transcript of an interview with John Stean, conducted by Dr Pamela Lear, will be available at www.histmodbiomed.org.

menial jobs. All technicians in our division of Bacterial Chemistry, with the exception of the Head Technician and Deputy Head Technician, were expected to spend half a day a week in the prep room preparing stock solutions, wrapping and plugging pipettes and later on putting them into copper cans and sterilizing them, plugging conical flasks and preparing lots of glassware, wrapping glass Petri dishes and sending those up to the media room, and then going up to the media room and collecting the sterilized glassware and redistributing it all, among other jobs. As time went on, as was said earlier, people came in with degrees and then this system was a bit disrupted. Who was going to do this work? This was partly solved in the early days by introducing new grades – Junior Technical Officer grade and the Technical Officer grade, and maintaining a parallel system with the technician grades. Then a few years after that, the problem was partly solved by introducing porters into the divisions. Porters did the menial work such as going down to the stores and fetching and carrying various things, and it depended on the capability of the individual porters how much work you could give them. I was lucky later on, I had a retired engineer so I was able to ask him to do quite a few other tasks, so that took the pressure off.

Tansey: Did each division have their own porters?

Mathison: Most divisions did. Some of the smaller laboratories didn't.

de Rossi: Some did and some didn't. We were never lucky enough to ever get one. I don't quite know why, perhaps I was so blacklisted that they wouldn't even think about it?

Mathison: I think the reason was partly proximity to the stores, working on the fifth and sixth floor of the Institute with lifts which, at that stage, were extremely unreliable to say the least. These were Otis lifts, and replacement parts were unobtainable from stock and had to be made. Unfortunately the Medical Research Council made a bad choice of company to fit the replacement lifts and the men spent a lot of their time down at the Adam & Eve pub drinking, when they should have been working in pairs. I remember one, more conscientious than the rest, was working on the lift on the fifth floor by himself. Now he'd actually trained one of the cleaners called Charlie to learn how to go up to the sixth floor lift mechanism and release him if he was stuck in the cage. Charlie that day was ill and the lift had got stuck between the fifth and the sixth floor area and I heard him shouting for help and no one went to his help for about an hour, we left him there. I think the company went bust and if I'm right a new company came along and fitted new lifts. Now you can imagine working on

the fifth and sixth floors when both lifts are out of action – the goods lift hadn't been fitted and we had about 16 flights of stairs down to the lower ground floor to get our supplies, we were carrying liquid nitrogen and concentrated acids, cylinders of compressed gas – times were very, very difficult. I think that did justify our having a porter.

de Rossi: I think the fire doors were the things that really scuppered you when you were going through into your floor. I can remember I'd got three or four cages, I suppose there were 36 mice in each cage, and as I went through the doors one of them just caught and tipped over and, of course, the mice went whoops! The cleaning staff were waiting to go for their cup of tea and I've never seen cleaning staff move so fast in all my life. One lady stood on a chair and the rest just sort of disappeared. I was careering round trying to catch all these mice. I did hate those fire doors for that reason; they really made coming off the stairs into the floor hard, hard work.

Marsh: I just want to talk about the lifts a little. I did work on the sixth floor for, I think, 13 years, so I know about the lifts and about the refurbishment. The original lifts were built by Waygood Otis, they know about lifts, I think they've done a few. What had happened with the lifts was the control gear had worn out, it was unreliable. But the MRC, in its wisdom, went for the minimum quote they could get, like they always do. I think it was a company called Eastop that came in to fix the lifts.

Mathison: They used to go 'eee' and then stop. [Laughter]

Marsh: They're the ones. So, they got Eastop in and they said: 'Yes, yes, we'll refit those' and they took out every single thing. I was talking to the engineer who was doing it and he said to me: 'What needs doing here are the electronics. They're knackered. We need new control gear in but the mechanics are fantastic. The stuff we're putting in is nothing like as good as the stuff we're taking out.' What an awful shame that was. Another little anecdote about the lifts, and I'm not sure if John can put me right on this, but when a director retired they used to have a party for him in the library among other things. I can't remember which director it was, I think it was Sir Arnold. So we're all in the library drinking wine and waiting for Sir Arnold to turn up, and everyone's saying: 'Well, where the hell is he? We've been up here for ages.' It turned out he's stuck in the lift somewhere up between the second and third floor with his secretary and they were there for ages and ages and ages and no one could get them out.

Turner: That was the newly refurbished lift as well!

Marsh: Yes, it must have been by then.

Turner: It made the front page of the *NIMROD News*.

Marsh: Well, it would do, wouldn't it? Working on the sixth floor, I did use the lift from time to time and the lift had two buttons on it, one for up and one for down. I worked out that actually the most efficient way of getting where you wanted to go, if you weren't at the top or the lower ground, where obviously there was only one button, was to press the button going in the opposite direction to the way that you wanted to go, and if anybody's interested I'll explain the principle behind that. If you work out all the different scenarios of what can happen like the lift being full or someone else above you calling it or whatever, if you want to get in first and go most quickly, press the one the opposite way that you want to go. So that's worth knowing about lifts.

Mathison: One of the problems we had was with the fire exercises. Not long after I got to the Institute, I found that all areas had a fire warden. We had our own firefighting group, in-house trained, and I think it was at least a two appliance call out if there was a problem, because of the danger. It was like a tinder box. Reading through the fire instructions, I noticed that all fire wardens were expected to go down and stand in the Fletcher Memorial Hall, which had a wooden floor and was immediately above the stores. As a fire warden, we had to check all the members of our division or labs through, tick them all off, report to the fire officer, and then go down to the place of assembly. So we would be burnt to a cinder while we were checking that last person out. Now it came to a climax when this particular obligatory exercise assumed the fire was in the stores, all staff were expected to concentrate in one area, go through the Fletcher Memorial Hall where there were only two exits and stand on the wooden floor right above where the fire was supposed to be. So I made a noise about that, and it was changed. A few years later, having moved to the fifth and sixth floors there was no fire escape and I know we had fire doors fitted but we had to go down 14 flights of stairs before we could get to the ground floor. It was my responsibility, as a fire warden, to check all the labs were empty before I escaped – there were dark rooms, hot rooms, and such like, and it usually took me three or four minutes to reach the ground floor. Within those fire door areas there were at least two inspection cupboards, which were regularly kept locked; if you opened those, as the maintenance people used to, you could actually see right through down to the boiler house through the grill. When the painters came and started working in the boiler house, we were the first people to smell the paint on the fifth floor so it was quite obvious fire doors would offer little protection. Year after year,

the request for a fire escape was turned down but I managed to get a petition running and a visit was arranged for a high ranking fire protection officer to meet the two heads of divisions, Robin Holliday and Mike Gaze, and myself.¹⁹⁴ We met on the fifth floor and, after giving us a lecture about wedging fire doors, he said: ‘Well, you’re alright, you’ve got fire doors, you just wait here for us to come and rescue you.’ I’d already made enquiries and I’d found there was only one turntable ladder in north London that was tall enough to reach the fifth floor. Now I have on good authority that firemen prefer to carry escapees down the ladder as some people panic and block the escape. About 40 people worked on the fifth and sixth floors and escape by ladder would take too long. In the end we did get our fire escape but it was very difficult.

Tansey: What date was that, Ian?

Mathison: I would guess it was about 1976 or 1977.

Tansey: Comparatively late.

de Rossi: We were lucky on the second floor because we had the only fire escape that had been built, the turret on the end.¹⁹⁵ We had a big space just behind this door where we could go out down the stairs and we had a high speed centrifuge behind it and we never told anybody it was there because they would have immediately made us move it because it was on the fire escape. We always said: ‘Well, when anybody else tore past us to get out there we’d know it was time to move out.’

Morgan: Yes, I now realise that was one of the great advantages of having worked in the Mellanby Building. We’d know when the fire alarm was going and we thought of all the poor souls up the hill going out in the rain while we were all snug having coffee on our top floor.

Changing subjects, one group of people who haven’t been mentioned are the washing up ladies who did absolutely wonderful work. We had two lots of three during twenty years in our division and one of them, if she met some visitors, would say: ‘Oh, I’m just a washing up lady.’ If I was nearby and I heard this I’d say: ‘June, that is not true. You are the most important person in the team, or one of the most important people, because if you don’t do your work properly,

¹⁹⁴ Robin Holliday was head of the Genetics Division, Mike Gaze was the scientific head of the Developmental Biology Division, and Ian Mathison was shared Head Technician.

¹⁹⁵ Mr Ian Mathison added: ‘... of the south east wing – serving lower ground, ground, first, and second floors’. Note on draft transcript, 18 November 2015.

and I know that won't happen, everyone's experiments go to pot.' They really are the base of good experimentation and I think they're worth their weight in gold when you get good washing up people.¹⁹⁶

Sawkins: This is perhaps a bit more anecdotal but about engineering. Over the years that I've been here, Roger and I have been intimately involved with the cobalt-60 source.¹⁹⁷ In fact, we quite have quite affectionate memories of it. On one occasion we spent a whole weekend here with a very ancient Canadian engineer, who we subsequently found out was actually the designer, and went out to dinner with him when they were mechanically rebuilding it because it had some gear problems. Subsequent to that we actually moved it and moved the electronics, for which we had a whole load of stuff rebuilt, and we reinstalled the whole thing and spent a lot of time doing this. But, as both Roger and I know, if you want to get into the Cobalt source at any time the only thing you actually need is a six-inch ruler, because we can override all the interlocks just using one six-inch ruler. It entertained us for several years, didn't it Roger?

Hooper: It did indeed.

Tansey: Do you agree with that account, Roger?

Hooper: Unofficially.

Mathison: Just a quick anecdote. We've already mentioned Miss Jones, the sister in charge, and she was there in 1953 when I started, and she had a habit of talking about people's ailments in public. I had developed ulcers on my tongue, probably through mouth pipetting *Staphylococcus aureus*, and I used to go down to the medical room for regular treatments. She had some antiseptic which she put on my tongue and it was getting better. One day I went along the first floor corridor to get into the lift to go up to the canteen – I think it was lunchtime – Sister Jones was standing in the corner with about five other people so there's just room for me to get in. She looked at me and she said: 'Oh, hello

¹⁹⁶ See also Professor Gustav Born's comments on the importance of his departmental cleaner at the Royal College of Surgeons research laboratory; 'We had ... our delightful cleaner, Scotty Fenn [Mrs Isobel Mills-Fenn], who became a close personal friend and godmother to one of our children' (Reynolds and Tansey (eds) (2005), page 56).

¹⁹⁷ Mr John Sawkins wrote: 'The cobalt-60 was a radiation source, the housing of which was built into the hillside, in the grounds of the NIMR. Roger and I worked together on this piece of equipment over many years, with major modifications too and upgrades of both the mechanical and electronic systems. If I remember correctly it was used to sterilise animal feed, as well as providing a variable dose source for animals.' Email to Ms Caroline Overy, 1 July 2015.

Mr Mathison. How is your, er, thing?’ So very quickly I said: ‘Oh, you mean my ulcerated tongue? It’s a lot better, thank you’, there was quite a lot of giggling before we got to the fifth floor. [Laughter]

Tansey: Sister Jones was one the first people I interviewed, with Arthur Hemmings, for my own history of the NIMR.¹⁹⁸ She tells a story of Sir Christopher Andrewes going down to her in the winter not feeling very well, sniffles and aches and pains, and then turning around to him and saying: ‘You’ve just got a common cold, Sir Christopher. You’ve just got a common cold.’ [Laughter]

Mathison: He should have known!¹⁹⁹

Tansey: Exactly.

Marsh: Did Sister Jones tell you, Tilli, what she did in the war? She drove an army lorry in the war as it turns out. She was telling me this one day as I gave her a lift home. I said: ‘Can you drive?’ ‘Can I drive?’ she says, ‘In the war I drove an army lorry.’

Tansey: There’s one thing nobody’s mentioned and that’s unions. It interests me when you’re talking about Health and Safety and some of the things that were going on and the difficulty of getting a fire escape. Where were the unions?²⁰⁰

de Rossi: Well, I was part of the union AScW (Association of Scientific Workers) and we used to go up to Half Moon Street for meetings. Every time we were very upset about something and I’d say: ‘We should do this’, they’d say: ‘Right, you’ve all got to come out on strike.’ This was always their thing and, of course, nobody would go out on strike, it was a waste of time. I can always remember Av Mitchison²⁰¹ was the chairman and we had a meeting to talk about pay scales

¹⁹⁸ The edited transcript of the interview with Sister Jones and Arthur Hemmings, conducted by Professor Tilli Tansey in 1992, will be available at www.histmodbiomed.org.

¹⁹⁹ Professor Sir Christopher Andrewes (1896–1988) worked at the NIMR from 1927 until his retirement in 1961. He was head of the Division of Bacteriology from 1940 to 1961 and Deputy Director of the NIMR from 1952 to 1961. In 1946 he set up the Common Cold Unit in Salisbury of which he was in charge until 1961. For a history of the Unit see the Witness Seminar ‘The MRC Common Cold Unit’: Tansey, Christie, and Reynolds (eds) (1998).

²⁰⁰ See the discussion on unions in Tansey (2008a).

²⁰¹ Avrion (Av) Mitchison (b. 1928) was Head of the Division of Experimental Biology from 1961 to 1971, with his research focusing on immunology. For interviews with Avrion Mitchison, including discussion of his time at the NIMR, see the Web of Stories website (www.webofstories.com/play/avrion.mitchison/1) (accessed 3 June 2015).

or something, but it was open to everybody because the scientists came as well. He forgot all about it so here am I, as vice chairman, trying to run this meeting, absolutely scared out of my wits, because I hadn't really done any preparation for it at all. But, every time there was something that they really didn't like their immediate reaction was: 'We must go on strike.' I must admit when I had some problems with my pension and the number of hours I worked, because I changed them when the children came, they were absolutely no help at all.

Mathison: Yes, I echo what Rosemary is saying. I think we felt that really these problems such as the lift problem and the fire escape problem should be dealt with in-house. I don't think anybody really wanted to take it to the union. I think it was a bit of an exception regarding pay because we did have a lot of problems in that respect and we felt we were being left behind. Certainly our fellow colleagues in industry were being paid a lot better. Added to that, of course, they had all the perks which were very difficult to assess. We didn't get any perks, not really. We weren't supposed to even accept bottles of wine at Christmas or anything like that. The most we got, I think, were calendars and things like that, and once a trip organized by Sorvall²⁰² to Twickenham, to the rugby match between Wales and England, but we weren't supposed to accept any of that. So yes, we used the unions but only for pay problems.

Marsh: I was in the union right from the off, not that I ever did anything. I wasn't interested in it but we all joined it – it was the AScW to start with, wasn't it? Then it was the ASTMS (Association of Scientific, Technical and Managerial Staffs) and the MSF (Manufacturing, Science and Finance), and loads of other things, I can't remember what they all were. But there was a time when something was upsetting somebody, it might have been to do with the crèche, I can't remember, but there were a couple of firebrand ladies, no names no pack drill, I hasten to add before I carry on, in the Institute who were members of the union and they decided the only way to deal with this was to go on strike. I heard this and I said: 'This is ridiculous, we can't start striking for things like this. We need to sort this out.' So I thought I'd better join the union committee and see what we could do. This sounds terribly arrogant but unfortunately this is what happened. I ended up becoming chairman of that committee and that led to me being on the local JNCC (Joint Negotiating and Consultative Committee), and that led to me being on the national JNCC, which met at Head Office, and which decided on all sorts of things like the

²⁰² Sorvall is a trademark of Thermo Scientific Fisher, which produces laboratory instruments and equipment.

new pay scales and heaven knows what. That was absolutely brilliant from my point of view because what happened was that I started learning things at Head Office that the Institute didn't know. Clive Russell, who was by then the chief administrator,²⁰³ discovered that I knew things he didn't know, about what was going to happen at the Institute and he didn't think this was very good, so all of a sudden, from being an absolutely, completely unimportant nobody, I was very important. This made a huge difference to me and I don't think, in the long run, that it did me any harm because I suddenly got on all these committees at the Institute who were deciding God knows what, and thought 'oh, they'd better have Jon Marsh on there'. Suddenly the profile went right up and I did say to Nick Clark: 'You want to get up to Head Office and get involved in these things. It makes a huge difference to your career prospects at this place because suddenly you're important.'²⁰⁴ That's what they care about.

Can I change the subject now and talk about procurement of old kit? Going back to the 1950s now – before my time but I did talk to Pip Piper about this and I've got an email from him here and he says that: 'In the 1950s we used to hire a van from the Blue Star garage, or we used to use the Institute van which was run by a bloke called Chantril.' Some of you might remember old Chantril the van driver, he was a bit of a grumpy bloke as I recollect. But anyway they could go to these army surplus places, and for £10 they could fill up the whole van with army surplus kit, radar and radio kit, some of it was German, and it used to come from the RAE (Royal Aircraft Establishment) at Farnborough or from the AERE (Atomic Energy Research Establishment) at Harwell. They would take this back to the lab and dismantle all this to get the bits out of it that they used to make the instruments that they were making. Also, when Bill Lister came – he came from the Post Office Research Establishment at Dollis Hill, where he had some great contacts. Again with the Post Office, a bit like the MoD, there was loads of redundant kit. They used to overbuy everything and so we could go and get a whole load of stuff from their surplus department as well. Uniselectors – we made things out of those; before transistors and bells and things, uniselectors were a very good way of doing electronics.

²⁰³ Mr Jon Marsh wrote: 'Clive Russell was Assistant Director during Burgen and Rees's times. He was an administrator and came to the NIMR from Park Crescent. He retired from the NIMR. John Wills became Assistant Director when Clive went and John Skehel took over as Director.' Email to Ms Caroline Overy, 26 July 2015.

²⁰⁴ Nick Clark joined the NIMR in 1972 as a Junior Technical Officer in the Immunology Division, becoming Head Technician in 1985. He retired in 2011 as Lab Manager for the Divisions of Immune Cell Biology and Molecular Immunology.

Morgan: This is going back to the 1950s – I can't remember all the details, presumably it was something to do with the work they were doing on the flu virus – sometimes they had excess eggs and they used to be handed out. I don't remember if we gave a small donation. Was there a lady called Ida? She was the director's driver.

de Rossi: I don't remember a lady ever being the director's driver.

Morgan: Yes, she had a green uniform and used to come to the back door where we went down to Engineering or somewhere around there. When it was our turn, someone would phone up and say, 'Your turn for eggs', and you'd go up and get your six eggs to take home and do whatever you wanted with them.

de Rossi: We used to use any animals that were termed 'normal' because you always had a control group if you were doing experiments, as well as the group that you were injecting. It was funny, we did something with pullets at one time and, at the end of the experiment, we'd got the 12 left that were the controls, so we kept them, we fed them, we cooked them, and we had them at our Christmas party. We used to have parties regularly in the lab, cooking sausages in the fume cupboard and doing all sorts of terrible things, which Health and Safety would now have a nervous breakdown over.

Morgan: We used to heat the Christmas puddings for the party in the autoclave.

Marsh: Yes, I don't quite know how this came about but Pete might know more about it than me. Geese used to be bought for certain work and it used to happen for some reason or another, a month or so before Christmas. I don't know how this worked, but Rod King and I used to share cars into the Institute and he said to me: 'Ah, Jon, we've got a few geese to take home.' This is before the Christmas break. So I presume they were normal geese that nobody seemed to want anymore and they just happened to become available around Christmas. I said: 'Well, how are we going to get them home?' And he said, 'Oh, we put them in sacks and we put them in the back of your car.' I had an estate car then. So we tied these geese up in these sacks and they had their heads sticking out of the sack and we chucked them in the back of the car and off we went. They were perfectly content these geese, they seemed to be perfectly content as long as you were going along. But as soon as you stopped they suddenly stood up and got all interested in what was going on. So every time we got stuck in a jam these two geese would stand up and be looking out the back window, and they were still tied into these sacks.

Turner: Yes, I can confirm that because I worked with Rod. He started off actually with turkeys. We used them simply as blood donors.²⁰⁵ And strangely enough the experiments always used to seem to finish around mid-December. [Laughter] But then I'm not entirely sure where the geese came from. I have a feeling they may have just used the facilities of the farm,²⁰⁶ which were very underused in later days. I think someone may have just used the facilities there to raise geese for Christmas. But certainly we had turkeys as blood donors which we did actually make use of.

Marsh: Talking about blood donors, going back to the 1960s, we used to give blood at the Institute on a regular basis, I think twice a year. I'd never given blood and everybody said: 'Well, you've got to give it, everybody gives it so you're going to give it', we all had our names down. Everybody more or less in the Institute went up to the fifth floor and they used to do this bloodletting in the coffee room. They had four or five tables in there – I can't remember in those days whether we got an injection for anaesthetic or we didn't because they changed all that. I was absolutely petrified about this and I was worrying about it, I remember I could hardly sleep the night before. Anyway I went up and I gave my blood and that was that, and we had a cup of tea, no Guinness or anything. I can remember later in the day I was in the lift – it was working for a change – and I was going to go down and I'd done my technique of pressing the up button to go down, so I was in it already and it went on up and it got to the fifth floor and Miss Brodarty, who was a tiny little lady, had just given blood. The lift set off and by 4M (Mezzanine) she'd passed out. I caught her and you'd be amazed, she was only little but she didn't half weigh a lot.

Mathison: I don't think anybody's mentioned open days at this stage yet, and I refer to this document dated 18 April 1962 titled 'An open evening for relatives and friends of non-scientific staff.'²⁰⁷ There's a bit of an introduction about the Institute and then a lot about the divisions. Visitors were shown around the admin area, conference room, Fletcher Memorial Hall, the library, medical welfare, even the boiler house and the canteen. Then most divisions would put on a show, which was suitably aimed at non-scientific people to understand.

²⁰⁵ Mr Peter Turner wrote: 'We were working on a project with beta blockers and used purified material from the turkey blood in drug binding studies.' Email to Ms Caroline Overy, 1 July 2015.

²⁰⁶ See note 55.

²⁰⁷ A copy of this document has been archived with the records of this meeting in Archives and Manuscripts, Wellcome Library, London, at GC/253.



Figure 36: Programme of the Institute's 25th Anniversary Open Evening

Prior to these open evenings we prepared large charts and information like that, I think they were quite well received, I think this was touched on earlier – relatives and interested persons could come and see what their offspring and friends were doing at work.²⁰⁸ It was quite good and later on that developed into open days. I've got quite a bit of information about those. Then came the Institute's 25th anniversary celebrations and quite a number of divisions did partake in this, with the technical staff playing a very big part in the demonstrations.²⁰⁹

Turner: I was just going to say, I can remember certainly one open evening in probably 1974; I'd been at the Institute a couple of years because I remember my parents came down to see it. I'm not sure there were too many after that.

²⁰⁸ See also page 17.

²⁰⁹ The 25th Anniversary Open Evening of the NIMR was held on 6 May 1975. In the programme, Director Arnold Burgen wrote: 'You will see in the demonstrations how the methods of medical science become ever more sophisticated and complex, and at the same time how the tasks of the technical staff have become more demanding but also very interesting.' Anniversary Programme, page 4.

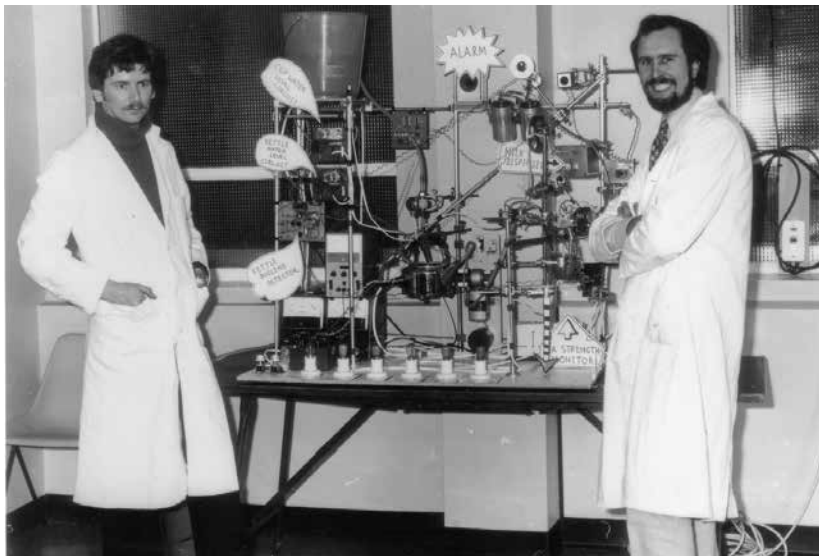

Figure 37: Mr John Satchell and Mr Jonathan Marsh with the tea-making machine made to demonstrate electronics measurement and control during an open day at the NIMR

Marsh: I think there were a few. There certainly was an open day after that because if you look at the photographs, there's one of the tea-making machine which John Satchell and I made – I don't know how long it took to make this thing, it's ridiculously trivial, but it would make a cup of tea and flash loads of lights and sound alarms and God knows what (Figure 37). It was just a jokey thing and it was in the main corridor. I think that was an open day, I'm not sure if that was for relatives as they normally came in on an evening occasion. But it was very important – that was an excellent thing to do.

Latterly we did have some open days that Rod King and I organized with Marilyn Brennan to get the Mill Hill Historical Society around the Institute and to spread the word of what the Institute was doing to the people outside. This was very important because over the years the publicity had been very bad about the Institute. We had demonstrations by the animal liberation people for a long, long time and, latterly, in the last 10 years or so I was there, they were there – every Wednesday night they were outside. The work of the NIMR was important but details of the actual work were kept secret from the demonstrators.²¹⁰ They put fences up, you couldn't get in. I said: 'I think this is completely the wrong thing to do. What we should do is to invite these people

²¹⁰ Mr Jon Marsh wrote: 'This was from fear of negative publicity regarding working on animals.' Email to Ms Caroline Overy, 23 October 2015.

in and let them see what we're doing and I'm sure that's the way to stop this.' However, they never did that. But we did have these open evenings for selected people and, as I say, one of them was the Mill Hill Historical Society. I can remember very well walking down the main corridor with the Director, John Skehel,²¹¹ whom I've got an enormous amount of admiration for, and all down the corridor there were these pictures of scientists who had done important work and a little bit about whatever they'd done. He, off the cuff, walked down that corridor and talked about every single piece of research. He knew all about it, it was very impressive. You were there, John, weren't you? I can remember thinking that if only we'd had a recording system for that, as you've got here [i.e. at this meeting], it would have been a brilliant thing to record.

White: There might be two groups that have been missed out, and that's the Photographic Department and the Graphics Department. I was thinking at these open days of all these photographs, all these posters, all that Letraset that was painstakingly applied; I think those groups are worth a mention and probably the scientists can reminisce about those?

Turner: Yes, I'm not quite sure Steve aimed it at me, but certainly Letraset and the like was the thing, there were no computer graphics to speak of in those days and they spent enormous amounts of time producing these wonderful things.

Morgan: Before Letraset there was a stuff called Uno Stencils – you'd just get to the end of doing a diagram and you'd smudge it and you'd have to start all over again.

Marsh: You could scratch it off with a razor blade.

Morgan: Now he tells me! [Laughter]

Marsh: We did Uno Stenciling – it took ages to make these demonstration boards up, didn't it?

Morgan: Then there were the papers that our bosses did and all the diagrams and the graphs and things.

Mathison: The trouble with the Uno Stencil pens was when they were allowed to dry out. There would be a solid block of Indian ink in this pen and you'd take ages to try and clean it up. The stencils often got blocked up too so you could hardly get the pen down in between the spaces.

²¹¹ Sir John Skehel was the Director of the NIMR from 1987 to 2006; see pages 182–3 for further biographical details.

I've got a National Institute for Medical Research open day for press and industry document here dated 27 March 1984 and I've got a list of representatives from industry.²¹² There were people from Amersham; Beecham; Cambridge Life Sciences; Celltech; Hoechst, Merck, Sharp & Dohme – the list goes on and on. These people were invited to see our demonstrations, which was quite interesting. I think the advent of the animal liberation movement and Health and Safety all had an effect in reducing the number and style of presentations at such open days and evenings. In fact, I think they stopped.

Tansey: Perhaps it's time for us all to stop also. I get the sense that you're all a bit tired. It's half past five, we started at ten o'clock. So I'm going to suggest that we finish now and have a glass of wine. Thank you all very much for coming and sharing all your memories.

²¹² A copy of this document has been archived with the records of this meeting in Archives and Manuscripts, Wellcome Library, London, at GC/253.

Appendix 1

Floor Plans of the NIMR at Holly Hill²¹³

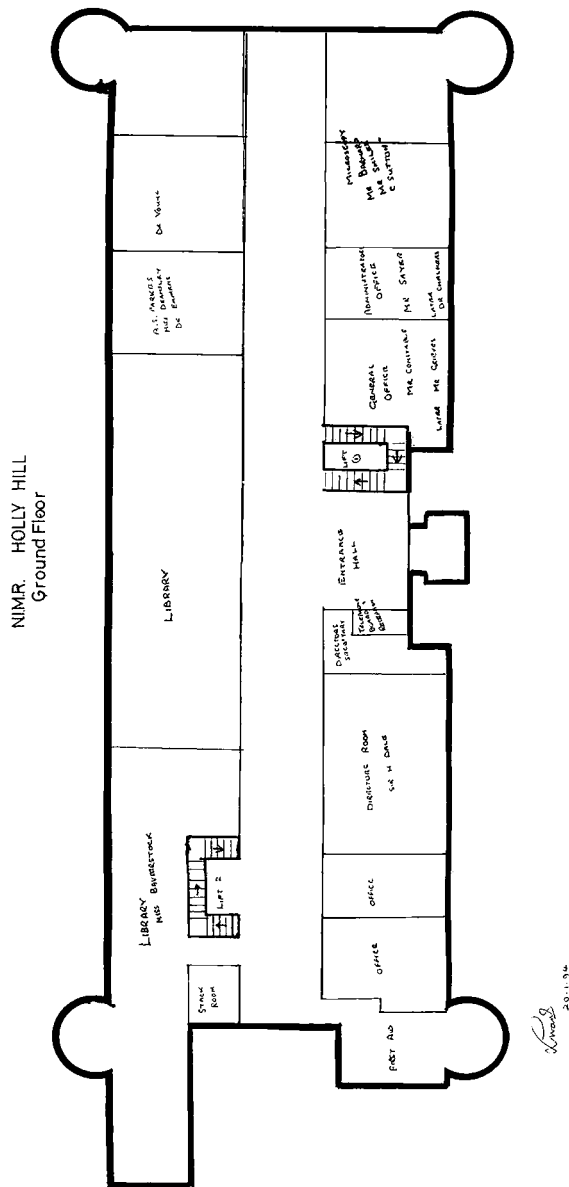

²¹³ Floor plans of the NIMR, c. late 1930s, drawn by Mr Leonard Ward for Professor Tilli Tansey; see page 10 and note 18. Further drawings are available online with the pdf of this volume: www.histmodbiomed.org.

Appendix 2

The Fraction Collector²¹⁴

An important device employed in chemical and biochemical analysis that was constructed at the NIMR was an improved fraction collector used in column chromatography. Around 1947, A J P Martin built what was probably the first automatic fraction collector for Anthony James while they were at the Lister Institute, not long before the move to Mill Hill. Jon Marsh described the role of technicians in its improvement at Mill Hill: ‘This was used to collect fractions from a chromatography column. The early versions used a siphon that collected the fraction. The siphon was connected to a balance mechanism, and when, say, 10ml had been collected, the weight of the siphon caused it to tip, the siphon emptied its fraction into the collection tube, and then tipped back, activating a mercury switch. This moved the tray, bringing the next collecting test tube into place under the column siphon. By the early 1960s these were commonly used at the NIMR and were becoming available commercially. There was a snag with this system as the siphon could cause contamination from sample to sample. During the 1960s we designed a new device to overcome this. This did away with the siphon and substituted a drop counting system. This consisted of a drop head, which contained a light source and a photocell (actually a phototransistor). This detected the passing drops, which an electronic circuit counted. After a preset number of drops, the electronic circuit sent a signal to move the tray as before. This system avoided any sample-to-sample contamination and also was more flexible as a simple electromechanical counter could vary the number of drops and thus the sample size. This is an example of an NIMR design that was adopted widely by external manufacturers. There were in fact many examples of NIMR designs that became world standard equipment.’

²¹⁴ Text supplied by Dr Anthony Travis from an interview with Mr Jon Marsh.

Appendix 3

A History of the Chemistry Laboratory: Form and Function²¹⁵

Dr Peter J T Morris

The design of laboratories remained stable for long periods of time. The initial design, what many people think of as an alchemical workshop, was centred on the furnace. William Lewis' laboratory in Kingston upon Thames in the mid-eighteenth century (Figure 1) was scarcely any different from an alchemical laboratory two or three hundred years earlier (Figure 2). There were several furnaces, not much in the way of organized storage except a few shelves, the fireplace mantelpiece, and the window ledges, hence considerable 'tidy clutter'. It was a laboratory for an individual chemist carrying out a number of different tasks using a large array of equipment, perhaps with the help of an assistant or an apprentice.



Figure 1: Engraving of an alchemical laboratory from *Philosophical Commerce of Arts*, William Lewis, 1765

²¹⁵ This paper is based on my recent book: Morris (2015),



Figure 2: An alchemical laboratory from Ercker L. (1683) *The Laws of Art and Nature in Knowing, Judging, Assaying, Fining, Refining and Inlarging the Bodies of Confin'd Metals*. London: Thomas Dawks



Figure 3: Chemical Laboratory of the Eidgenossische Technische Hochschule, Zurich, 1930

By contrast, the new chemistry laboratories at Zurich Federal Polytechnic (ETH), 150 years later, in the early 1900s, were completely different, with a laboratory layout familiar to many of us (Figure 3). The laboratory benches were prominent, they had bottle racks on their tops and washbasins on their ends, there was an aisle running down the middle of the laboratory, and there were fume cupboards at the windows. The benches were supplied with gas and running water. This was a laboratory building housing many chemists, all of them carrying out specific tasks in a given laboratory. Laboratories like this were universal for most of the twentieth century.

Between the 1760s and the 1860s, there was no universally agreed design of laboratory. However, by looking at the innovations made to different laboratories, we can see how the classical laboratory came into being. The first moving force was the rise of gas chemistry in the 1770s. It did not need heat or hence furnaces, but it did need large flat spaces for apparatus and specialized equipment to capture gases. Antoine Lavoisier's laboratory at the Paris Arsenal in the 1790s was markedly different from Lewis' laboratory forty years earlier (Figure 4). The furnace was absent, there were tables and a special water-tank table for experiments and pigeon-holes in the wall for storing apparatus. Everyone in the laboratory has a clear role to play in the experiment, from the laboratory assistant and the note-taker to the data collectors and the director of the experiment, Lavoisier. As the neat arrays of apparatus (rather than chemicals) indicate, Lavoisier's laboratory sprang from a different tradition, that of the physics cabinet rather than the alchemical workshop. However, Lavoisier was the exception and it was the physics laboratory that became the laboratory of tables and racking rather than the chemistry laboratory.

Justus Liebig's celebrated laboratory at Giessen in the 1840s had several similarities with the classical laboratory (Figure 5). There were benches, but they are along the wall, and tables were still present in the laboratory; there were reagent shelves but they were also against the wall and hidden behind glass. Above all, this laboratory had the first fume cupboards (draught closets) at the end of the room. There were several people in the laboratory and already they were beginning to carry out similar kinds of work. The 1840s was a period when chemical work began to be increasingly systemized, whether it be the combustion analysis of Liebig or the group analysis of metallic salts.

Chemistry, both organic and inorganic, was becoming increasingly dangerous, and fume cupboards were needed to avoid death and injury from accidents. The danger was increased in the 1840s by the introduction of group analysis as

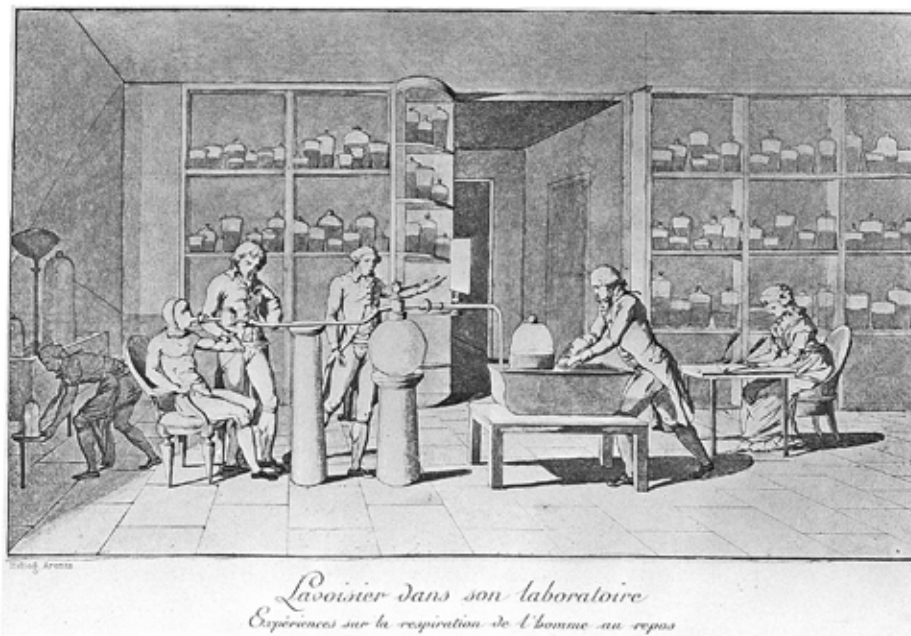

Figure 4: Lavoisier experimenting on the respiration of a man at rest, with his wife taking notes



Figure 5: Liebig's laboratory at Giessen

it used the highly toxic gas hydrogen sulphide. Hydrogen sulphide is so toxic that it is surprising it was a standard feature of the laboratory for most of the twentieth century. It was generated by the iconic Kipps apparatus, which also appeared in this period. The early fume cupboards were relatively inefficient and often dependent on the use of the draught from a naked flame, hardly safe in the presence of volatile solvents.

Yet we have not reached the classical laboratory: the furnace is still in place and modern utilities such as water and gas have not yet arrived. The modern bench and bottle rack first appeared in two laboratories in London, which owed much to Giessen, namely the laboratory of the Pharmaceutical Society in 1845 and the Birkbeck Laboratory of University College London in 1846. But it was Robert Bunsen in Heidelberg in 1855 who first brought piped gas and running water together at the laboratory bench and indeed DC electricity as well using an ingenious system of running the current from a central battery through the water pipes. Gas allowed Bunsen to develop the Bunsen burner and running water, the filter pump, both of which played a major role in chemistry over the next century or so. Thanks to the hot flame of the Bunsen burner, Bunsen and Kirchhoff were able to develop the new field of atomic spectroscopy. But Bunsen was also one of the first chemists to build a laboratory building rather than a single laboratory. This building contained specialized rooms for techniques such as gas analysis and a lecture hall. The chemist was becoming part of a community of scientists and technicians rather than the solitary worker of the early eighteenth century.

However, it was the introduction of piped steam, pioneered at London's Apothecaries' Hall in the 1820s, but only widely introduced in the 1860s, that finally removed the need for a furnace and allowed the classical laboratory to appear (Figure 6). Another important development in the 1860s was the introduction of plumbed drainage into the laboratory, removing the need to empty barrels regularly.

During the second half of the nineteenth century much effort was put into forced ventilation of laboratories as professors became aware of the reluctance of students and researchers to use fume cupboards, but the draught conflicted with the draught in the fume cupboard, largely leading to abandonment of the idea until electric fans solved the problem in the early twentieth century. Professors also tried to promote safety by creating spaces for outdoor experiments – either a space alongside the laboratory building, on the roof or even (as in Berlin and

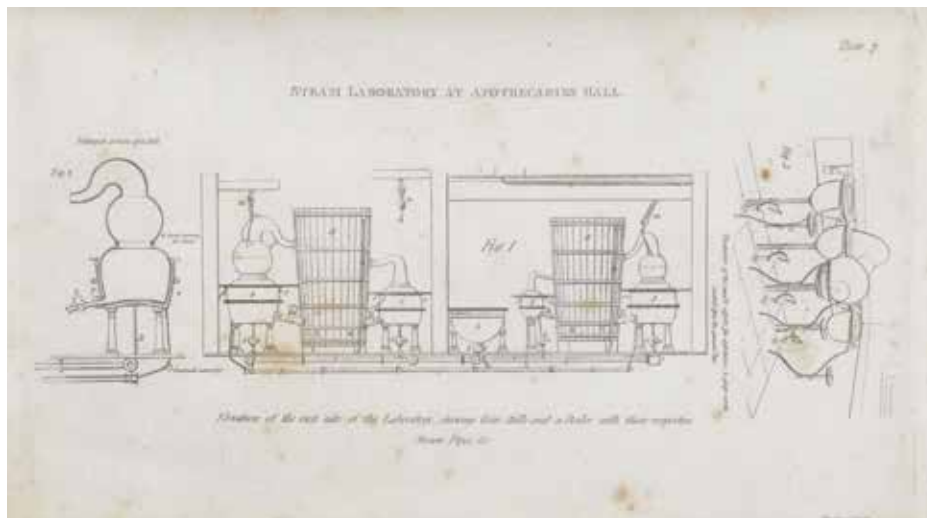

Figure 6: Steam distillation at Apothecaries' Hall

South Kensington) open-air loggias. However, these al fresco laboratories were unpopular and were soon dropped in practice, although they did continue in the GDR [East Germany] until the 1970s at least.

As well as increasing the number of laboratories within the laboratory building, professors also attempted to maximize the use of the space in a given laboratory to accommodate the growing number of students and researchers, a process that continued until the 1960s. One feature of this was the central aisle in the laboratory, similar to the aisle in a hospital ward. The rise of new techniques such as gas analysis, combustion analysis for organic compounds, spectroscopy, and polarimetry created a need for specialized rooms separate from the laboratory itself. As chemistry departments grew in size, the director became increasingly important and in Germany, the new classical laboratories would often have lavish living quarters for the director.

One feature of the laboratory building which is scarcely known today was the chemical museum. This was not a history of science museum of the type we know today but more like a geological museum. Typically it contained samples of compounds, apparatus, and models, but also the products of chemistry such as porcelain or fertilizer. They were used for teaching rather than for visitors and they were often next to or near a lecture theatre. Although the early ones were often repositories of chemicals, by the end of the nineteenth century, especially in the USA where they were particularly popular, they had become museums of applied chemistry, with the samples provided by manufacturers. The heyday

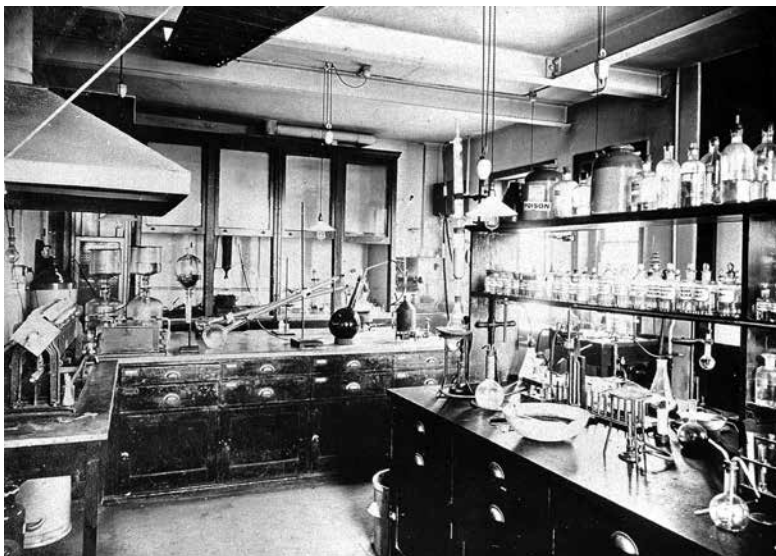

Figure 7: Wellcome Chemical Research Laboratory, 6 King Street, 1899

of the chemical museum was between 1880 and 1920, when nearly every new chemical laboratory had a museum and they were mostly closed or removed to the entrance foyer by the 1950s.

Once the classical laboratory had been established in Germany in the 1860s, notably Berlin and Bonn, where the two laboratory buildings were designed by August Wilhelm Hofmann, they were eagerly copied by other countries, often with the help of Hofmann, who thereby entrenched his model of the laboratory across the globe. Notable examples include the Normal School of Science in South Kensington in London, Lehigh University in Pennsylvania, and the new laboratories at Zurich Federal Polytechnic in the 1890s. However, not all American universities followed the German model closely. Some, like Lehigh, did, but others, such as MIT [Massachusetts Institute of Technology], had the benches to one side rather than a central aisle. The bottle racks in American universities tended to be metal and may have been removable. Certainly they were often less prominent than in European universities. The final triumph for this model was the New Sorbonne in Paris, which was built along Hofmannian lines in the 1890s despite the antipathy between France and Germany in this period.

Even non-academic laboratories built for industrial research or food analysis tended to copy the classical design. While the first research laboratory at Bayer in Germany, which opened in 1891, looked more like a factory than most laboratories of the period, the research laboratory at BASF from the same

period is much more like an academic laboratory. The Government Chemist's laboratory in the Strand, London, opened in 1897, was based on Sir Edward Thorpe's earlier laboratories at Leeds, which in turn were based closely on Hermann Kolbe's laboratory in Leipzig, built three decades earlier in the 1860s. It should be noted, however, that the works laboratory within the factory was very primitive in comparison to the industrial research laboratory until the second half of the twentieth century.

Of the laboratories built between the 1890s and the 1980s, there is little to say as the design scarcely changed. Mains electricity was introduced in the 1890s but this only had a limited impact on its design. For many years, the major consumer of electricity in the chemical laboratory was the projector lamp in the lecture hall. The main benefits of electricity were for ventilation and fume cupboards and for lighting, although Cambridge University, at least, used gas light until the late 1940s.

The primary driving forces in the post-war period were the improvement of the benches using new materials, either compressed asbestos cement or phenolic resins, and the ergonomic arrangement of the benches to make best use of increasingly crowded laboratories and simplify the supply of utilities. The benches were moved towards the wall or windows to create peninsula benches and the central aisle was eliminated.

This type of design was used in the new Stauffer chemistry laboratories at Stanford University in California in 1961. The Stanford laboratories showed how the classical laboratory could accommodate the new physical instrumentation that had entered chemistry in the 1950s. One simply replaced the combustion apparatus or spectroscopy with a mass spectrometer or NMR spectrometer. It helped that the combustion room had often been in the basement, which was convenient for the heavy mass spectrometers. However, when the second phase of the Stauffer Laboratories at Stanford was completed in 1963 the basement connecting the two laboratory buildings was used to house the heavy mass spectrometers and NMR spectrometers.

After over a century of dominance, the classical laboratory had a new rival by the 1990s. This new type of laboratory arose in the pharmaceutical industry and arose partly because the introduction of the suspended bench or C-frame (from its shape) allowed a more flexible design for laboratories. Drawing from their experience as manufacturers, the pharmaceutical industry was also very concerned with health and safety and had the funds to build a wholly new

type of laboratory. The key year was 1995, when Fisons Pharmaceuticals (now AstraZeneca) and Glaxo Wellcome (now GSK) opened new laboratory buildings.

One of the first academic laboratories to be built in this new style was the chemistry research laboratory at Oxford University, which was opened in 2004. The key to the design of the new building is segregation. Chemical areas ('dirty areas') are separated from office areas ('clean areas'), as shown by the different floor-coverings. Furthermore, the administration and professors' offices are separated from the laboratory area by an atrium. The atrium not only divides the building but also brings researchers together in its social areas and café as sociological studies have shown that this mingling of groups promotes better research.

The laboratories themselves are sealed off from the office areas but with glass walls so that the people in the office area can see if something goes wrong in the laboratory. The laboratory still has a white plastic bench running down the middle of a fairly small room but it is dominated by the fume cupboards on either side. This is specifically the case for organic chemistry, but the emphasis is on flexibility – the fume cupboard is replaced by a glove box in some inorganic chemistry laboratories and removed altogether in some biochemistry laboratories. Indeed, it would be possible in principle to convert the laboratories into office areas if the need ever arose.

Whereas academic laboratories of the 1950s and 1960s had specialized rooms that catered for the routine needs of researchers and high-end research, the laboratories now have small specialized rooms across the corridor, which contain instruments such as NMR or HPLC-MS machines. They can be used by the researchers themselves as the samples are loaded automatically into the machines and the results stored on a PC. The specialized areas still exist in the basement for the high-end research, but even here many of the machines can be used by non-specialists.

Is this type of laboratory the future of the chemical laboratory? One possibility is that a larger version of the new laboratory design for teaching purposes will appear (as has been proposed for Oxford), but it will be difficult for several people to work simultaneously in such a confined space even if it is a larger space. This brings us to the other problem with the new laboratory design: that it is very expensive to erect and operate. For this reason I surmise that a modified version of the classical laboratory, with C-frame benches and more

fume cupboards, will continue to be built (or installed in refurbished laboratory buildings) for many years yet. The organic chemistry teaching laboratory in the new chemistry buildings at Leipzig University (opened in 2000) is exactly of this type. On the other hand, the refurbished teaching laboratories at the University of Bristol are very similar to the CRL laboratories, but have a different layout, partly to avoid the problem of crowding.

Hitherto most histories and even most scholarly studies of laboratories have been about the people working in them or the research carried out within their walls. I would like to make a plea for more studies of the actual buildings and rooms themselves, their design and architecture, their location in the town, the arrangement and size of the rooms within the building and the purposes for which they are used, the materials used in the construction of the laboratories and their fittings, the fittings themselves and the equipment placed in the laboratories and, finally, the utilities and services supplied to the laboratory. Only when we have several studies which cover these features of the laboratory will we truly begin to understand how modern science has developed and functions.

Select Bibliography

Anderson R G W. (2013) Chemical laboratories, and how they might be studied. *Studies in History and Philosophy of Science Part A*, **44**: 669–75.

Benz G, Hahn R, Reinhardt C. (1996) *100 Jahre Chemisch-wissenschaftliches Laboratorium der Bayer AG in Wuppertal-Elberfeld, 1896–1996*. Leverkusen: Bayer AG.

Beretta M. (ed.) (2005) *Lavoisier in Perspective*. Munich: Deutsches Museum.

Beretta M. (2012) Imaging the experiments on respiration and transpiration of Lavoisier and Séguin: Two unknown drawings by Madame Lavoisier. *Nuncius* **27**: 163–91.

Brock W H. (1997) *Justus von Liebig: The chemical gatekeeper*. Cambridge: Cambridge University Press.

Brock W H. (1998) The chemical origins of practical physics. *Bulletin for the History of Chemistry* **21**: 1–11.

Carroll P T. (1982) Academic Chemistry in America, 1876–1976: Diversification, growth, and change. PhD thesis, University of Pennsylvania.

Chandler W H. (1893) *The Construction of Chemical Laboratories*. Washington: Government Printing Office I used the good quality reprint on demand by Kessinger Publishing.

- Chilton D, Coley N G. (1980) The laboratories of the Royal Institution in the nineteenth century. *Ambix* **27**: 173–203.
- Coleman, H S. (ed.)(1951) *Laboratory Design*. New York: Reinhold.
- Eklund J. (1975) *The Incomplete Chymist: Being an essay on the eighteenth-century chemist in his laboratory, with a dictionary of obsolete chemical terms of the period*. Washington, DC: Smithsonian Institution Press; available at <http://si-pddr.si.edu>.
- Ercker L. (1951) *Lazarus Ercker's Treatise on Ores and Assaying*, trans. from the German edition of 1580 by A G Sisco and C S Smith. Chicago: University Press.
- Ferguson W R. (1973) *Practical Laboratory Planning*. Barking: Applied Science Publishers.
- Festing E R. (1871) *Report of Visits to Chemical Laboratories at Bonn, Berlin, Leipzig, etc.* London: George E Eyre and William Spottiswoode, for HMSO.
- Fine L. (1988) The Chandler Chemical Museum. *Bulletin of the History of Chemistry* **2**: 19–21.
- Forgan S. (1989) The architecture of science and the idea of a university. *Studies in History and Philosophy of Science, Part A* **20**: 405–34.
- Forgan S. (1998) 'But indifferently lodged...': Perception and place in building for science in Victorian London. In Smith C, Agar J. (eds) *Making Space for Science: Territorial themes in the shaping of knowledge*. Basingstoke: Macmillan, in association with the Centre for the History of Science, Technology and Medicine, University of Manchester, 195–215.
- Forgan S, Gooday G. (1994) 'A fungoid assemblage of buildings': Diversity and adversity in the development of college architecture and scientific education in nineteenth-century South Kensington. *History of Universities* **13**: 153–92.
- Fors, H. (2003) *Mutual Favours: The social and scientific practice of eighteenth-century Swedish chemistry*. Uppsala: Uppsala Universitet.
- Fors H. (2006) J. G. Wallerius and the laboratory of enlightenment. In Baraldi E, Fors H, Houlitz A. *Taking Place: The spatial contexts of science, technology, and business*. Sagamore Beach, MA: Watson Publishing International, 3–33.
- Galison P, Thompson E. (eds) (1999) *The Architecture of Science*. Cambridge, MA: MIT Press.
- Gibbs F W. (1952) William Lewis, M.B., F.R.S. (1708–1781). *Annals of Science* **8**: 122–51.

- Gooday G. (1998) The premisses of premises: Spatial issues in the historical construction of laboratory credibility. In Smith C, Agar J. (eds) *Making Space for Science: Territorial themes in the shaping of knowledge*. Basingstoke: Macmillan, in association with the Centre for the History of Science, Technology and Medicine, University of Manchester, 216–45.
- Hammond P W, Egan H. (1992) *Weighed in the Balance: A history of the Laboratory of the Government Chemist*. London: HMSO.
- Hannaway O. (1986) Laboratory design and the aim of science: Andreas Libavius versus Tycho Brahe. *Isis* **77**: 584–610.
- Hill C R. (1975) The iconography of the laboratory. *Ambix* **22**: 102–10.
- Hofmann A W. (1866) *The Chemical Laboratories in Course of Erection in the Universities of Bonn and Berlin*. London: Printed by W Clowes and Sons; available in Google Books.
- Hogg W D. (1883) On the work done by the Paris Municipal Laboratory. *Analyst* **8**: 41–6.
- Holmes F L. (1989) *Eighteenth-century Chemistry as an Investigative Enterprise*. Berkeley, CA: Office for History of Science and Technology, University of California at Berkeley.
- Homburg E. (1992) The emergence of research laboratories in the dyestuffs industry, 1870–1900. *British Journal for the History of Science* **25**: 91–111.
- Homburg E. (1993) *Van beroep 'Chemiker': De opkomst van de industriële chemicus en het polytechnische onderwijs in Duitsland (1790–1850)*. Delft: Delftse Universitaire Pers.
- Homburg E. (1999) The rise of analytical chemistry and its consequences for the development of the German chemical profession (1780–1860). *Ambix* **46**: 1–32.
- Hutchinson E. (1977) *The Department of Chemistry Stanford University, 1891–1976*. Stanford, CA: Department of Chemistry, Stanford University.
- Hunting P. (1998) *A History of the Society of Apothecaries*. London: Society of Apothecaries.
- Jackson C M. (2009) Analysis and Synthesis in Nineteenth-century Organic Chemistry. PhD thesis, University College London.
- Jackson C M. (2011) Chemistry as the defining science: Discipline and training in nineteenth-century chemical laboratories. *Endeavour* **35**: 55–62.
- James F A J L. (ed.) (1989) *The Development of the Laboratory: Essays on the place of experiment in industrial civilization*. Basingstoke: Macmillan Press Scientific & Medical.

- James F A J L. (2001) Harriet Jane Moore, Michael Faraday, and Moore's mid-nineteenth century watercolours of the interior of the Royal Institution. In James Hamilton (ed.) *Fields of Influence: Conjunctions of artists and scientists, 1815–1860*. Birmingham: University of Birmingham Press, 111–28.
- James F A J L, Peers A. (2007) Constructing space for science at the Royal Institution of Great Britain. *Physics in Perspective* **9**: 130–85.
- Jensen W B. (1991) To demonstrate the truths of 'chymistry'. *Bulletin of the History of Chemistry* **10**: 3–15.
- Kikuchi, Y. (2013) *Anglo-American Connections in Japanese Chemistry: The lab as contact zone*. New York and Basingstoke, Hampshire: Palgrave Macmillan.
- Klein U. (2007) Apothecary's shops, laboratories and chemical manufacture in eighteenth-century Germany. In Roberts L, Schaffer S, Dear P. (eds) *The Mindful Hand: Inquiry and invention from the late Renaissance to early industrialization*. Amsterdam: Koninklijke Nederlandse Akademie van Wetenschappen, 247–76.
- Klein U. (2008) The laboratory challenge: Some revisions of the standard view of Early Modern experimentation. *Isis* **99**: 769–82.
- Kohler R E. (2008) Lab history: Reflections. *Isis* **99**: 761–8.
- Krätz O. (1982) Zur Geschichte des chemischen Laboratoriums. In E H W Giebeler, Rosenbauer K A (eds) *Historia scientiae naturalis: Beiträge zur Geschichte der Laboratoriumstechnik und deren Randgebiete*. Darmstadt: G-I-T Verlag E Giebeler, 1–24.
- Lang H. (1858) *Das chemische Laboratorium an der Universität in Heidelberg*. Karlsruhe: Müller.
- Lees R. (ed.) (1993) *Design, Construction and Refurbishment of Laboratories*, vol. II. Chichester, Sussex: Ellis Horwood.
- Lees R, Smith A F. (eds) (1984) *Design, Construction and Refurbishment of Laboratories*. Chichester, Sussex: Ellis Horwood for the Laboratory of the Government Chemist.
- Lewis H F. (ed.) (1962) *Laboratory Planning for Chemistry and Chemical Engineering*. New York, London: Reinhold Publishing Corporation; Chapman & Hall.
- Lourenço M C, Carneiro A. (eds) (2009) *Spaces and Collections in the History of Science*. Lisbon: Museum of Science of the University of Lisbon.
- Martinón-Torres M, Rehren T, Osten S von. (2003) A 16th century lab in a 21st century lab: Archaeometric study of the laboratory equipment from Oberstockstall (Kirchberg am Wagram, Austria). *Antiquity* **77**: available at <http://antiquity.ac.uk/>.

- McKee R H, Scott C E, Young C B F. (1934) The Chandler Chemical Museum at Columbia University. *Journal of Chemical Education* **11**: 275–8.
- Meyer-Thurow G. (1982) The industrialization of invention: A case study from the German chemical industry. *Isis* **73**: 363–81.
- Mills J. (1902) The Government Laboratory. *Strand Magazine* **21**: 561–71.
- Morrell J. (1993) W H Perkin, Jr., at Manchester and Oxford: From Irwell to Isis. *Osiris*, 2nd Series **8**: *Research Schools: Historical Reappraisals* 104–26.
- Morris P J T, Campbell W A. (2004) 'Analisi chimica'. In Petruccioli S (ed.) *Storia della scienza*, volume VII, *L'Ottocento – Chimica*. Rome: Istituto della Enciclopedia Italiana 554–79; available online (without the illustrations) at www.treccani.it/ (accessed 6 April 2016).
- Munby A E. (1931) *Laboratories: Their planning and fittings*. London: G. Bell & Sons.
- Nawa C. (2014) A refuge for inorganic chemistry: Bunsen's Heidelberg Laboratory. *Ambix* **61**: 115–40.
- Paul H W. (1985) *From Knowledge to Power: The rise of the science empire in France, 1860–1939*. Cambridge: Cambridge University Press.
- Ramberg P J. (2015) Chemical research and instruction in Zürich, 1833–1872. *Annals of Science* **72**: 170–86.
- Reinhardt C. (2006) *Shifting and Rearranging: Physical methods and the transformation of modern chemistry*. Sagamore Beach, MA: Science History Publications.
- Richards G. (2011) *50 Years at Oxford*. Bloomington, IN: AuthorHouse.
- Robins E C. *Technical School and College Building*. London: Whittaker and Co.
- Rocke A J. (1993) *The Quiet Revolution: Hermann Kolbe and the science of organic chemistry*. Berkeley, CA: University of California Press; available online at <http://publishing.cdlib.org/> (accessed 6 April 2016).
- Rocke A J. (2001) *Nationalizing Science: Adolphe Wurtz and the battle for French chemistry*. Cambridge, MA: MIT Press.
- Roscoe H E. (1878) *Description of the Chemical Laboratories at the Owens College, Manchester*. Manchester: J E Cornish.
- Rosenlund S J. (1987) *The Chemical Laboratory: Its design and operation, a practical guide for planners of industrial, medical, or educational facilities*. Park Ridge, NJ: Noyes Publications.

- Schwepe, J H. [1989] *Research aan het IJ: LBPMA 1914–KSLA 1989: de geschiedenis van het 'Lab Amsterdam'*. Baarn, Netherlands: Shell Research, printed by Bosch & Keuning.
- Shackelford J. (1993) Tycho Brahe, laboratory design, and the aim of science: Reading plans in context. *Isis* **84**: 211–30.
- Simcock A V. (1984) *The Ashmolean Museum and Oxford Science, 1883–1983*. Oxford: Museum of the History of Science.
- Simmons A. (2014) Stills, status, stocks and science: The laboratories at Apothecaries' Hall in the nineteenth century. *Ambix* **61**: 141–61.
- Smith P H. (2006) Laboratories. In Park K, Daston L. (eds) *The Cambridge History of Science*, vol. III, *Early Modern Science*. Cambridge: Cambridge University Press, 290–305.
- Stanziani A, Atkins P J. (2007) From laboratory expertise to litigation: The Municipal Laboratory of Paris and the Inland Revenue Laboratory in London, 1870–1914. A comparative analysis. In Rabier C. (ed.) *Fields of Expertise: A comparative history of expert procedures in Paris and London, 1600 to present*. Newcastle upon Tyne: Cambridge Scholars, 317–38, available at www.dro.dur.ac.uk (accessed 6 April 2016).
- Strecker, A. (1854) *Das Chemische Laboratorium der Universität Christiania*. Christiania [Oslo]: Brögger & Christie.
- Tilden W A. (1922) *Chemical Discovery and Invention in the Twentieth Century*, 4th edn. London and New York: Routledge.
- Voit A. von (1859) *Das Chemische Laboratorium der Königlichen Akademie der Wissenschaften in München*. Brunswick: F. Vieweg.
- Wallis T E. (1964) *History of the School of Pharmacy, University of London*. London: Pharmaceutical Press.
- Watch D D. (2008) *Building Type Basics for Research Laboratories*, 2nd edn. Hoboken: Wiley.
- Weyer J. (1992) *Graf Wolfgang II. von Hohenlohe und die Alchemie: Alchemistische Studien in Schloss Weikersheim, 1587–1610*. Sigmaringen: J Thorbecke.
- Williams R J P, Rowlinson J S, Chapman A. (eds) (2009) *Chemistry at Oxford: A history from 1600 to 2005*. Cambridge: Royal Society of Chemistry.
- Young J A. (ed.) (1987) *Improving Safety in the Chemical Laboratory: A practical guide*. New York and Chichester: Wiley.

Appendix 4

Computers at the NIMR

Mr Steven White

During my time at the NIMR (from December 1980 to April 1985) there was a transition in computing hardware from the large mainframe computer to the personal computer. Prior to this, automation of laboratory experiments by control of motors, actuators, temperature, light, pressure, plotting, etc. had to be through dedicated instruments or dedicated circuits or a combination of controls. These circuits were made from discrete analogue devices, logic gates, and microprocessor boards. Logical circuits had to be built from scratch using logic building blocks. With the availability of microprocessors it can be seen in the NIMR annual reports that Motorola M6800 and M6502 8-bit microprocessors were starting to be used in 1978.²¹⁶ This progressed to BBC B computers containing M6502 microprocessors, but with the added advantage of keyboard, colour cathode ray tube display, digital and analogue interfaces, data storage (disks), and sound. The combination of these features meant that control of experiments could be made simple, with most requirements being handled in the laboratory, including processing of the data, presentation, and printouts. Experimental setups created with the BBC computer could also be integrated using the same processor (M6502) to make small portable equipment minus the need for keyboard and cathode ray tube monitor. Code could be developed on the BBC computer and then transferred to the dedicated control board containing a M6502 processor.

Alongside the introduction of personal computers and microprocessors was the data communications backbone in the Institute, which, during my time frame at the NIMR, was handled by 8-bit serial data interfaces attached to laboratory equipment. These links were for transmitting/receiving information between laboratories and the main computer building. The computing department had further data communications beyond the Institute via the Joint Academic Network (JANET) (1984) and others. Some laboratory equipment was automated by the manufacturer by the addition of IBM and Apple computers, but these were sidelined by BBC B computers by the Engineering Department due to their adaptability and low cost. In some cases the BBC B computer was able to replace the manufacturers' recommended computer accessory and was merely used to accept data collected from an instrument and process and present the results.

²¹⁶ A microprocessor is a single chip device for computing purposes requiring support chips such as memory and display.



Figure 1: DEC 2040 mainframe computer

Some examples of just a few experimental setups using BBC computers developed by the Engineering Department are: cell sorter facility; insulin infuser drop volume analysis; battery lifetime test rig; optical tympanometer; stopped flow analysis (Biophysics lab); nanosecond fluorimeter (Biophysics lab); fluorescence recovery after photobleaching (FRAP Biophysics lab).

The importance of being able to control a number of functions (motors, actuators, temperature, light, pressure, plotting, etc.) led to more elaborate experimentation, which has continued to the present day. By the time I left the Engineering Department every engineer and technician had their own BBC B computer on their desk linked to the mainframe computer.

Details of computers from the NIMR annual reports

1978/1979 NIMR annual report

Computing laboratory – HP3000 time sharing computer, terminals

Use of microprocessors such as Motorola M6800 microprocessor to provide user with a dynamic display not possible on the time-shared computer

Note use of IBM 3740 protocol diskettes (8-inch floppy disk) to share information with other labs. No internet at this time as such. JANET (<https://en.wikipedia.org/wiki/JANET>; accessed 21 June 2016) did exist in a few laboratories

1979/1980 NIMR annual report

Report installation of DEC2040 mainframe computer

Also DEC PDP11/34 single user system

Early test bed for insulin infuser based on Motorola 6800 microprocessor. Also mentions use of 8748 Intel microprocessor for tests on diabetic dogs

1980/1981 NIMR annual report

DEC 2040 to be upgraded to DEC 2060

DEC PDP 11/34

First mention of Apple Microcomputers in use

Motorola 6800 still in use

First mention of integrated circuit for insulin infuser design

1981/1982 NIMR annual report

DEC 2060 mainframe installed

Insulin infuser project well under way

6502 processor used by Chris Bunn in the optical tympanometer project (processor type was not mentioned in annual report)

Page 123 ‘The use of small computers has continued to spread throughout the Institute. All are capable of accessing the DEC 2060 and so provide local intelligence for data capture and sometimes preliminary analysis. Further analysis can be done on the 2060. So far machines have been established in Developmental Biology, Biophysics, Neurophysiology, Engineering, Immunology and Neurobiology. Most are used for data acquisition from experiments or equipment. In all cases either PDP11 based systems or APPLE computers have been used.’ NOTE – I think BBC B computers were certainly in use in Engineering at this time, but not mentioned in annual report

1983/1984 NIMR annual report

Striking change to the format of annual report. Group structures completely changed, with Technology & Management leading Biological Services, Computing and Engineering. Specialized detail is lost from the reports and readers are offered a list of published papers

No reporting of computing or microprocessors used hence no mention of BBC computers being used by Engineering as the preferred automation computer

The personal computers – Commodore PET personal computer 1977; BBC personal computer (released 1 December 1980); IBM personal computer (1981); Apple personal computer (Apple I 1976; Apple II 1977; Apple III 1981) – released from 1977 onwards had potential for use in laboratories, but at the NIMR the BBC B came to dominate for a while around 1983/1984. Flexibility from languages to interface connections was greatest with the BBC B computer.

Appendix 5

The Planimeter

Dr Anthony S Travis

In gas chromatography during the 1950s, the curves from chromatogram traces were cut out with scissors and weighed. This seemingly primitive, tiresome, procedure was widely adopted for quantitative estimation of components. Important for data handling, and not only in gas chromatography, was the need for a more rapid, accurate measurement of peak areas. Planimeters and automatic integrators were available, although much patience was required with the former, and overlapping peak areas were a problem with the latter. More accuracy was required, particularly in peak sensing.

Around 1962, H W Johnson of Shell Emeryville converted the detector output from a gas chromatograph from voltage to frequency. The latter was stored on magnetic tape and then played back to a computer. This gave improved, rapid peak area measurement, with the computer resolving overlapping peaks.

In 1966, John Lewin of the Electronics Division of the Engineering Department at Mill Hill devised a novel planimeter, a digital integrator for measuring peak areas for use in quantitative immunoelectrophoresis. This work was undertaken for a Dr Freeman of the Whittington Hospital. Previously, the gel from electrophoresis was dried then placed in an enlarger and projected. Curves were traced and, as in gas chromatography, were cut out and weighed.

The mechanism of Lewin's planimeter involved a kinematic engineering motion. The electronics worked using a linear graticule, a transparent grid of lines, in the X direction, with a photocell and detector that then triggered the height measurement with an A to D converted in the Y direction. Adding all the height values gave the area under the curve, and, though not originally designed for GC work, the planimeter, as Jon Marsh, Lewin's technician, who built the device, observed, 'also coped with overlapping curves, much more difficult to do with the cut and weigh method'.

Appendix 6

The First Decade at the NIMR, Mill Hill: The Instruments that Revolutionized Analytical Chemistry

Dr Anthony S Travis

Introduction

Among the showcases located in the Making the Modern World Gallery at the London Science Museum, one of the perhaps least noticed devices is the electron capture detector (ECD). Put together around 1960, it was a radical innovation that contributed immensely to the then embryonic field of rapid trace chemical analysis, based on gas chromatography, which enabled detection of substances at the low parts per million range. Gas chromatography (GC) and the detector not only transformed many areas of the chemical sciences but also studies of the environment, particularly atmospheric and water pollution, which received unprecedented emphasis, and research funding, following the publication of Rachel Carson's influential book *Silent Spring*.²¹⁷ Both the ECD and gas chromatography, moreover, are nothing less than spectacular tributes to the scientific and engineering prowess of staff at the National Institute for Medical Research (NIMR), of the Medical Research Council (MRC), located at Mill Hill, north London. For chemistry they represented one of the greatest milestones in what has become known as the Instrumental Revolution.

The MRC had been founded as a committee in 1913. Its research institute, the NIMR, opened in Hampstead during 1919, at the old Mount Vernon Hospital. Thirty years later in the autumn of 1949 it moved to Mill Hill. The director, since 1942, was Sir Charles Harington, an organic chemist-turned-biochemist, knighted in 1948. The formal opening of the 'Institute' took place in May 1950, in the presence of King George VI and Queen Elizabeth.²¹⁸

The NIMR, particularly after 1945, was a hive of seemingly madcap schemes and Heath-Robinson wonders stimulated by a can-do attitude, improvisation, imagination, reasoned analysis, intuition, or tacit knowledge, and an intellectual culture in which the wits of people trained in different

²¹⁷ Carson (1962; published in the UK during 1963).

²¹⁸ First International Congress of Biochemistry (1950).

disciplines were constantly tested against new frontiers. From this, there emerged several successful discoveries and innovations, some sent into manufacture.

While the centre stage in these cutting-edge endeavours was invariably taken by academically trained scientists, the supporting cast included technical staff, notably highly qualified and skilled engineers, as well as technicians who, over time, became imbued with the many tricks needed to convert rough notes or ideas into meaningful instruments and devices. Many technical staff were trained in-house, rather than at a university, within a framework that, through work-based learning, and support for pathways to specialist professional qualifications, engendered loyalty and commitment to the workplace. What also makes the technicians of significance here is their inventive roles in devising instruments and devices that in many cases became commercially available and widely used laboratory ‘black boxes’. Their specialist skills were needed to make and modify prototypes, work that in some cases was spread over several months. Moreover, since their careers at the NIMR were often long, unlike the many academically trained scientists, they were important in the transfer of skills to new entrants into laboratories and workshops. This cadre of specialists is all the more deserving of our attention, since, from the Mill Hill workshops and laboratories (and its affiliates and predecessors), as former technician Tony (Pip) Piper points out: ‘There were in fact many examples of NIMR designs that became world standard equipment.’

Tilli Tansey has recently reviewed the careers and work of the technical staff engaged in advanced medical research before and after creation of the NIMR, based on archival collections and interviews with former staff.²¹⁹ Here her study is extended to the development of devices that became essential to biochemical and medical analyses and, equally importantly, in a short time completely transformed analytical chemistry.

²¹⁹ Tansey (2008a).

Principal Actors

The main protagonists in this account are:

Archer John Porter Martin (1 March 1910–28 July 2002) was with the NIMR during 1948–1956.²²⁰ In 1938, he joined the Wool Industries Research Association, Leeds. From 1946 to 1948, he was head of the Biochemistry Division, Boots Pure Drug Company. In 1948, he joined the MRC, first at the Lister Institute for Preventive Medicine, then at the NIMR, Mill Hill. Martin shared the 1952 Nobel Prize in Chemistry for his work with Richard L M Synge on liquid-liquid partition chromatography. In the same year he was appointed head of the Physical Chemistry Division at Mill Hill. During 1956 to 1959 Martin was an external consultant to the NIMR.

Anthony Trafford James (6 March 1922–7 December 2006) was with the NIMR during 1947–1962.²²¹ James received his BSc in chemistry from University College London in 1943 (at that time the university was evacuated to Aberystwyth). As a young man who had experienced the impact of the depression years, he developed a deep interest in politics, and for some time was a committed socialist before supporting the conservatives; he also served as president of the National Union of Students. However, he chose science over politics. With Martin he developed gas chromatography (gas-liquid partition chromatography), a technique suggested by Martin and Synge in 1941. After James left Mill Hill he set up the Lipid Biosynthesis Group at the Unilever Research Laboratory, Colworth House. Later he became involved in national science research policy.

James Ephraim Lovelock (b. 1919) was at Mill Hill during 1951–1961. Lovelock graduated in chemistry in 1941, in which year he joined the NIMR at Hampstead. During 1946–1951, he undertook research at the MRC's Common Cold Research Unit, based at Harvard Hospital, Salisbury. Having constructed two sensitive anemometers, he used them to show, by animal experiments, that the common cold was not a consequence of exposure to a chilly draught. In 1951 he transferred to Mill Hill. There later in the decade he worked on argon and electron capture detectors for gas chromatography.

²²⁰ Morris (2008).

²²¹ Gurr (2012).

Technical Officer *Norman Lennox Gregory* (b. 1930) at Mill Hill, was a major contributor to the development of the argon and electron capture detectors at the end of the 1950s.²²²

Technician *Edwin Anthony (Tony, 'Pip') Piper* (b. 1922) joined the NIMR Instrument Laboratory (part of the Division of Biophysics and Optics) in 1947, following service in the Royal Air Force. He was appointed Technical Officer on 11 August 1947; Senior Technician II in 1956; and Chief Technician II in 1957. Piper worked with Lovelock on the ionization detector, during 1959, and for James in 1961 devised a proportional radioactivity counter detector that was coupled to a gas chromatograph. He retired in 1982.

Technician *Laurence Leslie Woodget* (b. 1912), originally trained as a watchmaker. After working at Cambridge with crystallographer Olga Kennard, he joined Mill Hill on 24 April 1954, was appointed Technician in 1956; Senior Technician I

²²² Mr Norman Gregory wrote: 'In my last year at school, 1949, and on into the mid-1950s there was conscription into the armed services and lads were coming back and telling how they were wasting their time whitewashing coal and cutting grass with scissors. I was a serious young chap aiming to be a scientist and hated the idea of wasting my time that way so, on graduating in physics from Imperial College in 1952, took a job as a development engineer with De Havilland Propellers in a section developing an air-to-air guided missile. That procured deferment for some six years until after the threat of conscription passed and gave me a lot of experience in designing novel electronic equipment. I then answered an advertisement from the NIMR for a post in the Engineering Division as a Technical Officer and went for interview with Jack Perkins. He explained that a new category of staff was being set up to bring in people with good academic qualifications to develop equipment and techniques to support the work of the Scientific Staff. The Technical Officers were not to be technicians and technicians were not to be recruited into the new grade; it would be more as a parallel to the Scientific Staff but with permanent appointments rather than their usual limited term appointments. I would not have accepted a post as a technician but this won me over. As it worked out, the initial specification was relaxed and the grades appeared to merge ... With Sir Charles's permission, I registered with London University External Department and worked full time for two years in Dr Lovelock's lab correlating the electron capture properties of halogenated aliphatic hydrocarbons with their chemical structure. This was mostly done whilst Dr Lovelock was away in the USA. He returned after the thesis was completed but was very complimentary and, through his influence with Sir Charles, I transferred to the Scientific Staff. I then moved for perhaps two years to a small group, part of the Chemistry Division, working in the Hampstead Laboratories.... My research there, under Gilbert Beaven and Edward Johnson, led to a paper in *J. Chem. Soc. [Journal of the Chemical Society]* on the gas chromatography and electron capture properties of chlorinated biphenyls. (In those days interested parties requested reprints; the supply ran out!) I returned to Mill Hill and Jack Perkins's unit but eventually moved to the newly formed Clinical Research Centre, firstly in the buildings previously used by the animal nutrition group behind the NIMR buildings at the bottom of the hill and then at Northwick Park.' Email to Dr Anthony Travis, 6 February 2016.

in 1957; Senior Technician II in 1957; and Technical Research Assistant in 1959. Woodget worked with Piper on gas chromatography detectors. He left Mill Hill in 1977.

Divisions at the NIMR undertook scientific research. Departments performed a support function. In 1920, there were three divisions: Bacteriology, Biochemistry and Pharmacology, and Applied Physiology. By the time of Harington's retirement in 1962, ten divisions were in existence.

A Revolution in Chemistry

In order to understand the role of the NIMR at Mill Hill in the transformation of analytical chemistry it is important to emphasize at the outset that what is described in the following was part of one of the greatest revolutions in analytical chemistry. This revolution was about instrumentation capable of separating and even identifying components in mixtures in ways that had not previously been possible. In addition, apart from contributions to chemical, biochemical, and medical research, Mill Hill developments were well suited to analysis of trace amounts, to process control, and to monitoring of the environment.

Ever since the time of Antoine Lavoisier chemical experiments, including analysis, had been mainly carried out in glassware. Though spectroscopy and X-ray analysis had been introduced into chemical analysis well before 1950, glassware still dominated analytical procedures. Handbooks provided both specific instructions and protocols for sample analysis. The methods were often long and tedious, particularly where separations were required to afford pure material. Limits of detection were restricted by the amount of material available and physical properties. Large volumes of solutions were sometimes required for estimations in the parts per million range.

That would all change with the widespread development of instrumental methods.²²³ None of these methods, however, could equal the role of chromatography, starting with work carried out by Richard Synge and Archer Martin at the Wool Research Institute. In 1941, they published a paper that laid down the theoretical basis of modern chromatography, partition chromatography, both column and paper, and which included the suggestion that a mobile vapour phase could be employed to carry out separations of mixtures. While column and paper chromatography flourished, vapour phase chromatography was not taken up at the time.

²²³ Morris (2002); Reinhardt (2006).

Martin joined the NIMR in 1948, at the invitation of Harington, to work on separation of biologically important substances.²²⁴ Synge moved to the Lister Institute in London, where he worked with biochemist Anthony Trafford James. It so happened that, while waiting for his Mill Hill laboratory to be completed, Martin was also at the Lister. A close working relationship developed between Martin and James; notably Martin devised an automatic fraction collector for use in column chromatography for James. As a result of their similar interests, James followed Martin to Mill Hill in 1949/1950.

This was the time when biochemistry was recognized as a major scientific discipline that had emerged during the twentieth century, a synthesis of biology and chemistry. Previously it was often treated as a subdiscipline, sometimes called physiological chemistry. Though major discoveries were mostly published in chemical journals, journals of biochemistry came into existence. Physiological societies in Britain and America during 1907–1908 classified proteins. A Biochemical Club had been founded in Britain, with around 100 members, in 1911. It was later renamed the Biochemical Society. The first international congress of biochemistry, held under the aegis of the Biochemical Society, took place in the summer of 1949 at Cambridge. There were 1,700 participants, more than twice the number originally expected. The NIMR's newly knighted Sir Charles Harington was chairman of the congress committee. At the meeting, an International Committee for Biochemistry was set up, chaired by Harington, whose remit was to ensure the continuation of international congresses in biochemistry.

The challenges of biochemistry stimulated some of the most significant advances in analytical methods in the post-war years.²²⁵ At Mill Hill, one challenge would stimulate, within months of the Institute's opening, the development of the chromatographic technique, gas chromatography, that would transform analytical chemistry. Historian Peter J T Morris with considerable justification has stated that: 'This was arguably the most important advance in chemical analysis since Bunsen and Kirchoff developed spectral analysis almost a century earlier [in 1859].' Moreover, Morris observes that: 'While new techniques take a decade or more to establish themselves ... despite its complexities, gas chromatography spread like wildfire in 1952 and 1953.'²²⁶ Overcoming many

²²⁴ Clayton and NIMR staff (2014), pages 147–8.

²²⁵ Cerruti (2002).

²²⁶ Morris (2002), pages 263–4.

of the complexities in designing and making the necessary instruments and components was often the special domain of the technicians.

Training Technical Staff from the 1940s

In the 1940s, the career trajectories of scientists and engineers followed paths quite unlike those of the following decades, when higher education became widely available, even to those of limited means. Often the men, and women, involved came from homes where the struggle to survive during the 1930s precluded full-time university education. This meant that self-advancement depended on evening classes while working, if they were lucky, during the day in laboratories. The main thing was to earn a living. Polytechnic training to Higher National Certificate (HNC) level was rigorous and involved many hours of bench work. It could also be a stepping stone to a part-time degree course. Even then, for the first half of the 1940s, wartime conditions often delayed completion of first degrees. Any reconstruction of laboratory life at the mid-twentieth century and shortly after must take into account these conditions. They were typical not only for several technicians and engineers but also for some leading scientists at Mill Hill, such as Anthony James.

In many cases, wartime enlistment from 1939 on provided hands-on training in skills, both during the war and in its aftermath, that could be put to good, and immediate, use, not only in medical fields,²²⁷ but also in engineering and electronics. Those skills had emerged from experiments, trials, and improvisations, sometimes in the battlefield, and with limited resources. Such experiences, once urgently required in the changeover from a wartime to a civilian economy, often counted far more than a first or second degree, and compensated for the lost years when war service substituted for formal education. During and after the war, the strength of common purpose and commitment remained strong. Erstwhile graduates found themselves acting out the roles of laboratory assistants and technicians, acquiring hands-on experiences that would pay off handsomely once they embarked on academic careers. At the same time, the exigencies of war had created new challenges and opportunities. This included a fascination with detectors and devices for separations that attracted not only physicists,²²⁸ but also chemists and biochemists.

²²⁷ Tansey (2008a), pages 85–6.

²²⁸ Galison (1997).

As Jon Marsh, formerly of Electronics at Mill Hill, points out in his reflections on being part of the NIMR community: ‘In those days it was unusual for engineering people to have high level (first degree, or PhD) qualifications. Many came from the General Post Office (GPO) or had armed forces training in the post-war years. They were not only motivated but also highly competent, and nowadays staff of their standing would probably have PhDs.’²²⁹

Tony Piper (E A Piper, or ‘Pip’) is an excellent example of a technician who used prior training in electronics in the armed services to advantage. His original expertise was as a skilled tool maker, though he held no formally recognized academic qualification. Around 1950, with C C F Payne, he contributed to the development and construction of a photoelectric control circuit required by James and Martin in their work on gas chromatography, in addition to design and construction of column heaters.²³⁰ In the late 1950s, Piper worked with James Lovelock on detectors for gas chromatography. His being a technician did not preclude Piper from appearing as an equal co-author in important scientific publications, some that contributed to the revolution in analytical chemistry.

The interests of scientists at Mill Hill were not connected with industrial production, but driven by blue sky research and ‘multidisciplinary fundamental research’, as Jon Marsh recalls. This was encouraged by the Institute’s outstanding director, biochemist Harington. ‘The whole beauty of this melting pot was the way that it sparked off ideas and innovations all over the place, even from the most obscure of interests. Scientists would join divisions according to their backgrounds and qualifications, but if they wished to work on a project that required them to enter or collaborate with another division or section they were allowed to do so.’²³¹

This playground of academic and inventive excellence relied on strong backup facilities, particularly an engineering department adept at transferring ideas into reality by making equipment from whatever was available. The department offered expertise in electronics, mechanical engineering, and fine instruments, and its resources included an abundance of surplus World War II electronic and control components. The outcome was that the Mill Hill establishment justifiably earned for itself an enviable reputation; the potentials of its discoveries excited attention from far and wide.

²²⁹ Jon Marsh, personal communication, 3 August and 30 November 2010.

²³⁰ James and Martin (1952), page 690.

²³¹ Jon Marsh, personal communication, 3 August and 30 November 2010.

Tony Piper: Hampstead and the Early Days at Mill Hill

On 11 August 1947, Tony Piper joined the NIMR Instrument Laboratory, at that time headed by Dr Bernard Wheeler-Robinson, who previously had worked on X-ray crystallography and aircraft instrumentation. Piper worked with Jack Perkins in a Nissen hut, in the grounds at Hampstead, shared with Biophysics, which housed its Siemens electron microscope there, as well as a small freeze drying and vacuum evaporation facility. He recalls: ‘For administrative purposes the Instrument lab was part of Biophysics. A little later a designer/draughtsman joined us at Hampstead. Before the move to Mill Hill, Dr Wheeler-Robinson left [in 1948] to head the Applied Physics Division at the NPL [National Physical Laboratory] and was replaced by Dr Kantorowicz [from the Parsons and Marine Engineering Turbine Research Development Association (PAMETRADA) at its Wallsend Research Station]. The designer/draughtsman also left.... When we moved to Mill Hill we had all of the North side of the NW wing. So as well as the workshop at the end there was a general purpose workshop for general use, our electronic laboratory, the drawing office, and an office for Dr Kantorowicz.’²³²

Technical staff were encouraged to construct bespoke apparatus if needed for use in their laboratories. To this end there was, as Piper mentions, the small engineering workshop, the General Purpose Workshop (GPW), part of the Engineering Department. Tony Piper undertook part-time study and received his City and Guilds Final Certificate in Telecommunications in 1958, at the time he was assisting James Lovelock with development of the first supersensitive gas chromatography detectors.

Supplies, 1945–1960

In the early days after the war, the availability of components to construct electronic apparatus was extremely limited. Technical staff became adept at assembling devices using war surplus items that were available from specialist suppliers, typically those retail shops that provided parts to radio hams (many of whom would become experts in various scientific and technical professions). Among the most well-known suppliers were shops in or close to the West End of London, notably Proops, and Smiths, of Lisle Street.

Tony Piper’s firsthand account describes how components, many important to the development of gas chromatography, were procured: ‘When I started at Hampstead the Government had a great deal of left-over material at service maintenance units. Universities and government research establishments were

²³² Tony Piper, personal communications, 2010.

given the opportunity to visit them and purchase items. We had the driver's (Chantrell's) NIMR van or hired one from Blue Star garages and we could get a van load of material for a nominal £10 although sometimes items of special interest were priced individually. We also acquired quite a lot of German radio and radar items from RAE at Farnborough. Another source of supplies was AERE at Harwell, who had a stock list of components, which could be ordered in the normal way, and they supplied many components that were unobtainable on the open market. When experiments with radioactive materials started AERE were also a source of scalers, ratemeters, and other monitoring and measuring instruments... The big breakthrough in acquiring supplies came when [the components suppliers] Radiospares and, later, Farnell, started which made acquiring electronic bits and pieces straightforward! We had previously ordered direct from manufacturers but they tended to have long delivery times.'

Gas Chromatography: A J P Martin and A T James

The ease and efficiency of the modern gas-liquid chromatograph for separating organic chemicals, as invented in 1950 by Archer Martin and Anthony (Tony) James, at Mill Hill, led to the widespread adoption of the method, as well as the development of highly sensitive detectors. By this time, Martin was already associated closely with analytical chemistry and biochemistry through liquid-liquid chromatography, the reverse-phase chromatogram, the paper chromatogram, etc.

Shortly after arriving at Mill Hill from the Lister Institute, Martin and James investigated the separation of short and medium chain volatile fatty acids for the biochemist George Popják, who was located in an adjoining laboratory studying the biochemical synthesis of milk fatty acids. For this work, instead of using liquid-liquid partition chromatography, one of the phases was chosen to be a gas, that is, they now resorted to gas-liquid chromatography. Nitrogen was used as a mobile gas phase. The gaseous mixture containing the components under study was directed through a column, a glass tube, filled with celite, containing a stationary phase, liquid paraffin. The column was installed in an oven. The components separated according to their boiling points. It was the first time that this type of gas phase analysis had been put into use. Little matter that the first attempt at separation failed. Several trials later, following numerous modifications to the setup, and changeover to ammonia and aliphatic amines as test substances, as well as using modifications of fatty acids, chromatographic traces showed that separation of components was indeed feasible. That was the start of gas chromatography.²³³

²³³ Martin (1969); James (1979).

Martin and James gave their first public demonstration of this method of gas-liquid partition chromatography to members of the Biochemical Society, at its 290th meeting, held at the NIMR Mill Hill, on 20 October 1950. A summary appeared early in 1951 in the *Biochemical Journal*. Good separation was reported for certain of Popják's products, 'the volatile fatty acids' using, they explained, 'a chromatogram containing a static liquid phase and a mobile gas phase of nitrogen'. Moreover, they pointed out: 'This method should be applicable to a very wide range of substances, possibly all those that can be distilled without decomposition, and possesses the advantage that the lower limit of quantity used is determined only by the efficiency of detection.'²³⁴

Detection at this stage was restricted to components that could be titrated, the fatty acids and amines. Shortly after, Neil H Ray of Imperial Chemical Industries (ICI) visited Martin and James to discuss 'the development of a *new* detector capable of responding to any substance'. According to James, 'though we suggested that [Ray] investigate infra-red detectors he, probably wisely, preferred to use the katharometer, a well-known device of reasonable simplicity'. (The katharometer, or thermal conductivity detector, had been marketed by the Cambridge Instrument Company from early in the twentieth century.) Martin, however, did not think much of the available katharometer, since it was flow-sensitive and required recalibration for quantitative work. He put together a modified version that was less sensitive to the flow. Samples were collected in a cooled gas stream. Around the time they were visited by Ray, Martin, for quantitative work, made his own single-pan torsion balance, a delicate device that was hardly robust.

In 1952, the new detector was put to the test with analysis of hydrocarbons and combustion products from the exhaust of James' car in the Mill Hill car park. It gave in half an hour results that would otherwise take a month or so to obtain on a 100-plate distillation column. Martin sent the chromatogram recording by mail to Anglo-Iranian Oil (from 1954, BP), with a request for samples of pure hydrocarbons, from the firm's collection built up during the war, for analysis. At Anglo-Iranian the impact of the chromatogram on Denis Desty and his boss S F Birch 'was fairly spectacular'.²³⁵ They immediately phoned Mill Hill and arranged to be there the very next day, an urgency that much surprised the two inventors of the new gas chromatography (GC) technique.²³⁶ Shell researchers,

²³⁴ James and Martin (1951), page vii.

²³⁵ Morris (2002), quoting Desty, page 265.

²³⁶ Morris (2002), page 264; Morris and Ettore (2007, 2008).

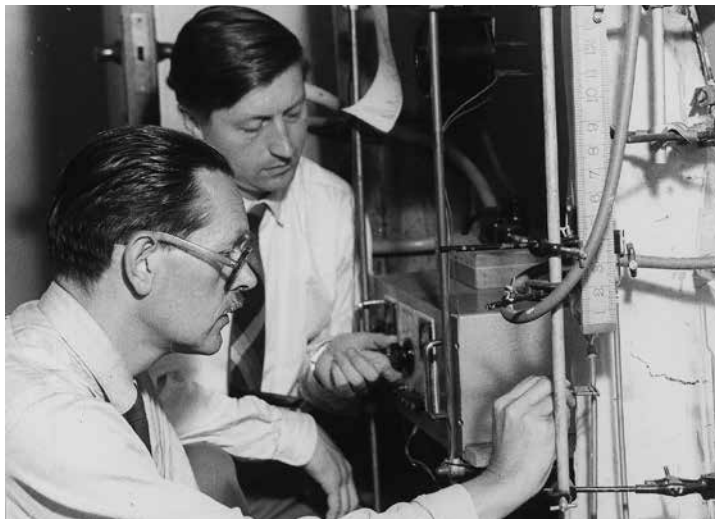

Figure 1: Archer Martin (left) and Anthony James at Mill Hill in the 1950s

through their contacts with ICI, came to learn of the Mill Hill developments, and expressed considerable interest. A I M Keulemans, of Shell's Amsterdam laboratory, visited Martin and James at Mill Hill, and immediately upon his return to Holland set to work on a GC detector in collaboration with Hendrick ('Hank') Boer.

In 1952 when Syngé and Martin received the Nobel Prize in Chemistry for their work on partition chromatography, the new gas-liquid partition chromatography received only a passing mention in the Nobel lectures. In September of that year, Martin and James demonstrated their new technique at the Dyson Perrins laboratory, Oxford, during the International Congress on Analytical Chemistry (of the International Union of Pure and Applied Chemistry), organized by the Society of Public Analysts. By this time they were able to demonstrate efficient separations of mixtures of fatty acids and hydrocarbons. As a result of their work, GC development was conducted at the Shell Thornton Research Centre, near Chester, particularly by Edward R Adlard. In the UK, Shell, ICI, Anglo-Iranian (BP), Associated Ethyl, and National Benzol all engaged in in-house construction and use of GC equipment, following the NIMR lead.²³⁷

James then encouraged Martin to consider a gas density balance, or meter, for detecting vapours leaving the chromatogram. This was quickly put together, first as a glass model. According to James, Martin was an expert at working with glass, so

²³⁷ Adlard (2003).

probably technical staff were not involved at this early stage. However, Engineering Department staff would have been required to translate glass into a half-size model made out of a block of brass, and a full-size model made from copper. The brass and copper detectors, with vapour heating jackets, were made by technicians Ralph Bower and D G Childs in the Engineering Department (Bower later became head of the department). The gas density meter, developed in September 1953, incorporated two identical, parallel columns, each filled with the same stationary phase, through which gas passed, one column fed from the chromatograph, the other column acting as reference. The presence of solute from the chromatograph flow resulted in a density difference. Equilibrium was restored by allowing gas to flow from one stream to the other, using an electrically heated wire loop detector. This was translated, via thermocouples, into an electrical signal, which was amplified and fed to a recording galvanometer.²³⁸ ‘The device, as expected, proved to be virtually flow insensitive and the best overall detector at the time.’²³⁹

The introduction of narrow capillary GC columns (rather than packed columns), based on Marcel J E Golay’s work (1956–1958), improved resolution, and became preferred in trace organic analysis. Direct coupling (hyphenation) of a mass spectrometer to a gas chromatograph enabled separation, collection, and identification of components, based on characteristic mass spectra peaks. This was introduced in the United States at Dow Chemicals (and Philip Morris) during 1955–56, and described, respectively, in 1956 at the spring meeting of the American Chemical Society, and the Fourth Annual Meeting of Committee E-14 on Mass Spectrometry, held in Cincinnati.

The gas density detector was covered by British patent application no. 2,486,464 of 1953. There were, for demonstration purposes, ‘two or three transparent Perspex models which then travelled all over the place, particularly to industrial companies who became interested’. These would have been put together with the assistance of the GPW. Interestingly, at this time patents were not generally taken out on NIMR inventions. No doubt in this case the significance of the detector for use in commercial equipment was recognized; by 1956 plans were made for it to become available from C F Casella, of London, and Griffin & George, of Alperton, Middlesex. Martin left the NIMR in the mid-1950s, apparently because he was annoyed that the patent for the gas density detector had been licensed to an American firm.

²³⁸ Martin and James (1956).

²³⁹ James (1977).

After Martin's departure, James followed up the gas chromatography studies at Mill Hill, using the technique to both separate and identify components. For this, he employed aniline and its derivatives, suggesting on the basis of his results that 'it should be possible to identify almost any volatile aromatic amine by its behavior on two or more types of chromatogram'.²⁴⁰ He continued with his interest in fatty acids, particularly their structures and modes of biosynthesis, for which GC analysis with the gas density meter was important.²⁴¹ James also collaborated with Lovelock. An important challenge was the development of an extra-sensitive and reliable gas chromatographic detector that provided measurable signals from the flow of components separated in time by the column. Once again, the technicians were invaluable collaborators.

Supersensitive GC Detectors: Tony Piper and James Lovelock

The development at Mill Hill of supersensitive GC detectors that afforded greatly enhanced sensitivity and selectivity followed studies in the mid-1950s by John W Otvos and David Stevenson at Shell Emeryville, in the United States. They developed a beta-ray ionization chamber based on strontium-90 for gas analysis. Their Dutch colleague, Boer, adopted this innovation in his own novel GC (cross-section) detector, though its sensitivity was not adequate for the sort of biochemical research carried out at Mill Hill, and may have been no better than the gas density balance or katharometer.

Ionization detectors depend on the property of conduction of electricity by gases. Under normal conditions of temperature and pressure a gas behaves as a perfect insulator. However, in the presence of ions or free electrons, the motion of charged particles towards an electrical field causes the gas to conduct, which can be detected. The flame ionization detector (FID), invented around 1956, is the most common type. It is useful in general organic analysis and offers low detection limits. However, its near universal response means that problems can occur in the analysis of complex mixtures. The detectors invented at Mill Hill during the second half of the 1950s offered improved detection limits and selectivity, and later were of considerable importance in environmental analysis. One detector was outstanding in its selectivity towards halogens and other electron capturing groups: the electron capture detector (ECD).

²⁴⁰ James (1956).

²⁴¹ James (1957).



Figure 2: James E Lovelock, c.1960

Boer described his detector at the first International Symposium on Vapour Phase Chromatography (an early name for gas chromatography), held in London during 1956, and at the same time made a visit to Mill Hill. There, Martin introduced him to James Lovelock, and they exchanged information on sensitive detectors. Lovelock was also working on novel detectors, leading to the argon-ionizing detector (1956).²⁴² Here argon is used as the carrier gas. Electrons are produced by bombarding argon atoms with beta particles derived from a foil containing strontium-90 as source. The electrons are accelerated across a potential of 1000V, collide with other argon atoms, raising them to the metastable electronic level. Eluting organic molecules ionize by collision with metastable argon ions.

Work on the argon detector at Mill Hill followed Lovelock's new interest in biochemical research, in part from studies on reanimating small animals. In the mid-1950s, with the aid of an ex-Royal Navy continuous wave magnetron, he revived hamsters using radio frequencies, a sort of microwave oven. He soon

²⁴² Boer (1979); Morris (2002); Morris and Etre (2007, 2008).

realised that damage to body cells during freezing was related to the fatty acid composition of lipids in the cell membrane. He then considered how it might be possible to measure the fatty acids at extremely low concentration. Fortunately, close at hand were Martin and James, whose early gas chromatography work had involved separation of fatty acid esters.²⁴³ They provided the solution to the problem, GC analysis, but, as they pointed out, only if a suitable detector could be invented. Lovelock has noted that, as at the Common Cold Unit, ‘we had either to make our own [equipment] or have it made in the Institute [NIMR] workshops’.²⁴⁴ Available to assist Lovelock in this endeavour were the experienced, talented staff Norman Gregory, Tony Piper, and Les Woodget.

Lovelock used the fact that an anemometer he had built at the Common Cold Unit was made from radium scraped from old aircraft gauges, typical of available surplus World War II equipment. It functioned on the principle of ion drift.²⁴⁵ The slow moving positive ions were readily disturbed by small air currents. Aided by the Mill Hill technical staff, Lovelock combined the work of the Shell researchers, Otvos and Stevenson, and Boer, with his use of the anemometer to put together the first of his novel detectors. It used the strontium-90 source of beta radiation, and argon as carrier gas. The first apparatus was assembled for Lovelock by Piper and Woodget of the Instrument Department.²⁴⁶ The cavalier handling of radioactive material in this work, which was then quite common, would be unthinkable today.

After various disappointments and trials, fatty acid esters at very low concentrations were successfully separated. The argon beta ray-ionization detector of Lovelock was described at the Second Symposium on Gas Chromatography, held, appropriately in view of the Dutch contributions, at Amsterdam in May 1958.

Lovelock’s argon beta ray-ionizing detector was introduced commercially by Pye in 1958. However, shortcomings prompted improvements, including greater reliability, and once more called on the skills of technicians. Aided by Tony Piper, James and Lovelock embarked on a new development.²⁴⁷ This was the beginning of

²⁴³ Morris (2002), page 263.

²⁴⁴ Morris (2002), quoting Lovelock, on page 262; Lovelock (1997).

²⁴⁵ Morris (2002), page 267.

²⁴⁶ Lovelock (1958).

²⁴⁷ James, Lovelock, and Piper (1959).

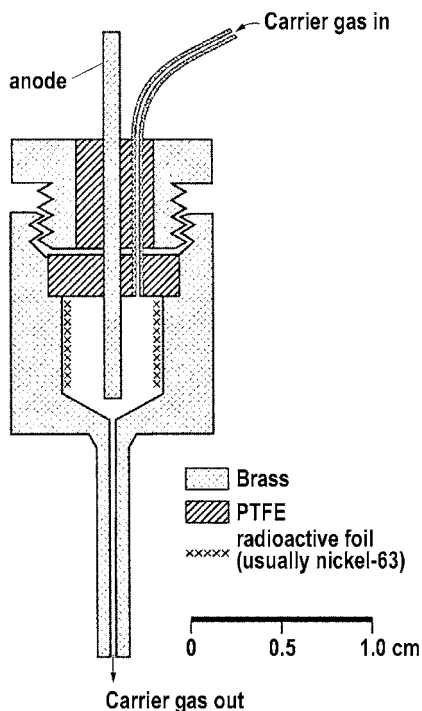

Figure 3: Diagram of Lovelock's electron capture detector

Lovelock's electron capture detector (ECD), dating from 1958–1960. Unlike the other ionization detectors, it measures loss of signal due to recombination (instead of measuring positively charged current). The carrier gas is nitrogen. Beta particles from a tritium source ionize the nitrogen molecules to afford slow electrons that move to the anode, giving a steady baseline current. The current flow decreases with the entry of an electron-capturing gas, and is, correspondingly, a measure of the amount and electron affinity of the components in the carrier gas. Lovelock spent a sabbatical at Yale during 1958–1959 working on this detector, and made several modifications, the outcome of which was the fully developed ECD. It was ideal for compounds that exerted a strong affinity for electrons, for example, halogenated hydrocarbons. However, it did not suit the analysis of hydrocarbons, and radioactive sources were considered problematic. As a result, the flame ionization detector (FID) was preferred for more general use. But the sensitivity of the FID could not compare with that of the ECD, which was introduced commercially by Perkin-Elmer and other firms during 1961–1962.²⁴⁸

²⁴⁸ Morris (2002), pages 269–72; Morris and Etre (2007, 2008).

Mill Hill Technical Officer Norman Gregory, who by part-time study received his MSc from the University of London in 1961, as assistant to ‘Dr Lovelock’, explains the main features of the argon and electron capture detectors on which he worked.²⁴⁹ His account shows a superb understanding of the complex science involved, something that was quite common among technical officers at Mill Hill:

The argon detector depends on the existence of a metastable excited state in the argon atom. The polarising voltage must be high enough to accelerate the primary electrons from the radioactive source to an energy at which they can excite the metastable state. The process is helped by the ‘elastic’ nature of the argon atom. In electron/atom collisions at energies below those giving rise to excitation very little energy is lost. The process may be interfered with by the presence of, for example, halogenated compounds which combine with the electrons before they can acquire the necessary energy. It is the application of this interfering effect that is the basis of the electron capture detector. In contrast, in molecular gases, such as the nitrogen which should be used as a carrier gas with electron capture detection, electron/molecule collisions excite vibrational states in the carrier gas molecule and the electron loses energy. Most electron attachment processes depend upon the electron being ‘caught’ by the molecule. It must not ricochet from the collision. Low polarising voltages should be used to keep the electron energy to quasi-thermal levels. I had not realised the importance of this when I started my thesis work but was able to demonstrate that capture depended on electron energy – not a good thing when I had gone to great trouble to devise a system which varied the detector voltage to keep the current constant! It did, however, enable me to make an estimate of the electron affinity of oxygen. This differed markedly from the then accepted value and would have made an interesting note had I got round to publishing it.²⁵⁰

In December 1962, Gregory filed a patent, as assignor to the National Research Development Corporation, for his gas analysis apparatus in which electrons, under the influence of an electric field, were accelerated from an ionization chamber to a detection chamber, for use in gas chromatography as well as in similar processes. It could be adapted as required to serve as either electron capture or argon detector.

²⁴⁹ Gregory (1961).

²⁵⁰ ‘The use of helium as carrier gas is bad in electron capture work as there is the “Ramsauer effect”. The helium atom behaves towards the electron as if it was not there. The electron can acquire energies far too high for optimal use as a normal, wide spectrum, detector.’ Norman L Gregory, email communication, 23 September 2011.

Tony Piper worked with James to develop for analysis of labelled fatty acids a novel proportional radioactivity counter that was coupled to a gas chromatograph fitted with a katharometer.²⁵¹ This method of radioassay was continuous, with automatic flow monitoring. It not only enabled separation of fatty acids and detection of their relative masses, but also contributed to further understanding of their biosynthesis, the topic of great interest to James. Eight models of the gas chromatograph which used the proportional counter were built by Piper for use in James' laboratory.²⁵²

Until the late 1950s, GC detectors were either too insensitive (thermal conductivity detector) or not sufficiently selective (flame ionization detector) for trace organic analysis in chemistry, biochemical, or medical research. As described in the foregoing, supersensitive detectors that overcame many of these problems were invented at Mill Hill around 1960. Independently, in the United States two other sensitive detectors were invented, by Coulson, and by Hall.²⁵³ Though highly selective, they did not offer the detection limit of the Lovelock detector, as low as 5×10^{-15} g. These became the most powerful tools in the rapidly expanding field of trace environmental analysis that was stimulated by publication of Rachel Carson's *Silent Spring*.²⁵⁴ In 1971, Lovelock used the ECD to report the persistence of chlorofluorohydrocarbons (CFCs) in the stratosphere. This had an important impact on the study of ozone depletion.

Conclusion

The tenures of each of Martin (1948–1956), Lovelock (1948–1961), and James (1947–1962) at the NIMR Mill Hill from 1950 covered the period of greatest and most rapid advance in modern gas chromatography, an endeavour in which for a decade the NIMR was the undisputed leader in the field. Their cutting-edge studies, however, would not have been possible without the skills and commitments of the remarkable cadre of technical staff, many of whom spent most, if not all, their working lives at Mill Hill. Scientific advances in instrumentation and devices that originated at Mill Hill were made widely known at conferences and through publication. In the case of the original invention of gas chromatography, it led to rapid far-reaching changes in chemical and biochemical analysis, and new advances elsewhere, often without

²⁵¹ James and Piper (1961).

²⁵² James (1995).

²⁵³ Morris (2010).

²⁵⁴ Rosen and Gretch (1987), page 131–8; Morris (2010).

financial benefit to the NIMR or its inventors. However, this certainly favoured widespread application, and contributed to the fame of Mill Hill. (By the mid-1950s, as the gas density balance demonstrates, that had changed, and there was a perceived need for generating revenue from new processes and instruments.)

Gas chromatography first emerged as an analytical technique for investigation of biochemical problems. It would remain important in that field as well as in all areas of general organic chemical analysis. It enabled rapid separations that previously had taken days or weeks, and transformed trace analysis. However, the key to a successful technique lay in finding suitable detectors. Here Norman Gregory, Tony ('Pip') Piper, and Les Woodget provided invaluable support and practical skills. Gas chromatography subsequently became important in analysis of trace contaminants in the environment. This was one of the most important applications of the new supersensitive detectors devised from the end of the 1950s by Lovelock and colleagues.²⁵⁵ Thus by 1960, at the Shell Research Centre, Sittingbourne, Kent, scientists studied detection of chlorinated hydrocarbon pesticides in crops using Lovelock's argon detector manufactured by Shandon Instruments; 0.035 ppm of aldrin and 0.07 ppm of dieldrin could be detected without clean up. With the electron capture detector, they established that 'the wide scope of the ... technique in the analysis of agricultural, atmospheric and industrial samples for trace halogenated pesticides is indicated'.²⁵⁶ Perkin Elmer subsequently modified its 452 GC instrument, as used by the Nature Conservancy, to study DDT residues at the Tunstall Laboratory of Shell in the mid-1960s.²⁵⁷ Once the potential of the new detectors had been established, they were adopted elsewhere, including at the US Forest Service and US Food and Drugs Administration. By around 1970, the Lovelock detector could detect chlorinated hydrocarbon pesticides in the nanogram (1×10^{-9} g) and picogram (1×10^{-12} g) ranges. Lovelock's detector was, and remains, the most sensitive detector ever developed for trace analysis of halogenated hydrogens, not only the pesticides but also in the air we breathe. This has had a tremendous impact on modern environmental science as well as on analytical chemistry.

Acknowledgements: Norman L Gregory, Jon Marsh, Peter J T Morris, and Tony (Pip) Piper are thanked for their invaluable contributions to this account.

²⁵⁵ Rasmussen (2002); Travis (2002, 2012).

²⁵⁶ Goodwin *et al.* (1960).

²⁵⁷ Walker (1966).

Appendix 7

Apparatus Used to Prepare Cell Walls

Mr Ian Mathison

Various methods were used to break up cells, some were more satisfactory than others. Grinding the cells using liquid N_2 in a pestle and mortar was tried, and the method using compressed N_2O to put the cells under pressure in a cylinder was also tried. The first method yielded little breakage; the second involved a 2 in. diameter \times 10 ft long Perspex tube placed upright over the outlet valve to catch the bacterial suspension when the valve was released. Not an effective method, it was unhygienic and made a loud hissing sound when released!

The next two methods used Ballotini – small glass beads about 0.3mm in diameter – to grind up the bacterial suspension. The ‘Mickel Disintegrator’ was used in the cold room ($2^\circ C$) and vibrated using an electro-mechanical method for about 10 minutes. The second method used the ‘Braun homogenizer’, which shook a metal container (containing suspension and beads), which was kept cool with a supply of liquid CO_2 . These two methods were quite effective, but separation of cell walls from glass powder was time consuming.

The next three methods used mechanical pressure to force the frozen bacterial suspension through a narrow gap to fracture the cells. The Hughes Press, made by the Engineering Workshop, was a 5 in. \times 5 in. \times 5 in. block of stainless steel with a round cavity approximately $2\frac{1}{2}$ in. deep and $\frac{3}{4}$ in. diameter into which a plunger fitted. The cube was in two halves, held together by four high tensile steel bolts. The block, plus plunger, were cooled in solid CO_2 , bacterial suspension was pipetted into the cavity, and, using the fly press in the Engineers Workshop, the plunger was pushed into the block. The block was opened in the lab and the refrozen cell preparation was recovered. The X-Press was similar, but not as effective; and the Aminco Press (from the United States) used a solid stainless cylinder, 7 in. long with a 1 in. diameter hole, also fitted with a tight-fitting plunger, which forced the frozen suspension past a nylon ball at the end of a steel tube.

From the three ‘metal block’ methods, the Aminco Press was more effective, easier to use, and there was no glass powder to remove. Commercially available equipment was not always satisfactory for purpose and some modification was needed, and therefore was made in the Engineering Workshop – this included the Hughes Press. The X-Press and the Aminco Press versions were commercial products.

Appendix 8

References by Sutherland *et al.* for Pump and Countercurrent Chromatography Research at the NIMR, showing NIMR Scientists (**Bold**) and NIMR Research Officers and Technicians (**Bold Italic**)

Professor Ian Sutherland

Insulin Infusion Pump

1. **Rothwell D, Sutherland I A, Parsons J A.** (1981) A new miniature insulin infuser (Abstract). *Diabetologia* **21**: 321–2.
2. **Rothwell D,** Pickup J C, **Sutherland I A.** (1982) Clinical problems and engineering solutions for open loop insulin delivery (Abstract). *Diabetologia* **23**: 196.
3. Bending J J, Pickup J C, Keen H, **Rothwell D, Sutherland I A.** (1983) Long term clinical evaluation of a new miniature insulin infusion pump. *Diabetes* **32**: 318.
4. Bending J J, Pickup J C, Keen H, **Rothwell D, Sutherland I A.** (1983) Meeting the problems of first generation insulin infusion pumps: Clinical trial of a new miniature infuser. *Diabetes Care* **6**: 452–8.
5. **Rothwell D, Sutherland I A,** Pickup J C, Bending J J, Keen H, Parsons J A. (1983) A new miniature, open-loop, extracorporeal insulin infusion pump. *Journal of Biomedical Engineering* **5**: 178–84.

LHRH Pulsatile Infusion Pump for the Treatment of Infertility

1. **Chambers G R, Sutherland I A, White S,** Mason P, Jacobs H S. (1984) A new generation of pulsatile infusion devices. *Upsala Journal of Medical Sciences* **89**: 91–5.
2. Jacobs H S, Adams J, Franks S, Kelly C, Mason W P, Morris D V, **Sutherland I A,** van der Spuy Z M. (1984) Induction of ovulation with LHRH – problems, indications and contra indications. *Journal of Steroid Biochemistry and Molecular Biology* **20**: 1382.

3. Mason P, Adams J, Morris D V, Tucker M, Price J, Voulgaris Z, van der Spuy Z M, **Sutherland I A**, **Chambers G R**, **White S**, Wheeler M J, Jacobs, H S. (1984) Induction of ovulation using pulsatile luteinising hormone releasing hormone. *British Medical Journal* **288**: 181–5.
4. **Sutherland I A**, **White S**, **Chambers G R**, **Rothwell D**, Mason P, Tucker M, Jacobs H S. (1984) A miniature infuser for the pulsatile administration of LHRH. *Journal of Biomedical Engineering* **6**: 129–33.
5. **Sutherland I A**. (1986) Micrometering in medicine: An historical perspective. *Engineering in Medicine* **15**: i–iii.
6. Armar N A, Tan S L, Eshel A, Jacobs H S, Adams J, **Sutherland I A**. (1987) Practical aspects of pulsatile LHRH therapy. *British Journal of Hospital Medicine* **37**: 429–36.
7. **Sutherland I A**, **Chambers G R**, Polson D W, Sagle M, Kiddy D, Mason H D, Franks S. (1988) Pulsatile infusion of gonadotrophin-releasing hormone (GnRH) – investigative and therapeutic applications. *Journal of Biomedical Engineering* **10**: 110–12.
8. Homburg R, Eshel A, Armar N A, Tucker M, Mason P W, Adams J, Kilborn J, **Sutherland I A**, Jacobs H S. (1989) 100 Pregnancies after treatment with pulsatile luteinizing hormone releasing hormone to induce ovulation. *British Medical Journal* **298**: 809–12.

Counter Current Chromatography (CCC)

1. **Sutherland I A**, **Sharpe J E E**. (1976) Counter-current chromatography using a new coil planet centrifuge. *Journal of Chromatography* **122**: 333–44.
2. **Lightbown J W**, **Newland P**, **Sutherland I A**, **Dymond J W A**. (1977) Analysis of candicidin and related polyene antibiotics by means of the coil planet centrifuge. *Proceedings of the Analytical Division of the Chemical Society* **14**: 34–7.
3. **Sutherland I A**, **Beaven G H**, **Lightbown J W**. (1978) Rapid high-resolution counter current chromatography separations with the coil planet centrifuge. *Trends in Biochemical Sciences* **3**: N133.
4. **Sutherland I A**, Lee J S, Gauvreau D J. (1978) Separation of quinoxaline antibiotics by coil planet centrifugation. *Analytical Biochemistry* **89**: 213–19.

Separation of Cells and Organelles using Aqueous Phase Systems
using CCC

1. **Sutherland I A**, Ito Y. (1978) Toroidal coil chromatography. *Journal of High Resolution Chromatography and Chromatography Communications* **3**: 171.
2. Ito Y, Carmeci P, **Sutherland I A**. (1979) Non-synchronous flow-through coil planet centrifuge applied to cell separation with physiological solution. *Analytical Biochemistry* **94**: 249–52.
3. Elles R, **Sutherland I A**. (1980) Purification of specific restriction fragments of human deoxyribonucleic acid by using liquid countercurrent chromatography. *Biochemical Society Transactions* **8**: 173.
4. **Sutherland I A**, Ito Y. (1980) Cell separation using two-phase polymer systems in a non-synchronous flow-through coil planet centrifuge. *Analytical Biochemistry* **108**: 367–73.
5. **Sutherland I A**, Lai J, Morris W B, Peters T J. (1981) Analytical subcellular fractionation of rat liver homogenates by countercurrent partition in a toroidal-coil centrifuge. *Biochemical Society Transactions* **9**: 174.
6. Wilkes J M, Leake D S, Morris W B, **Sutherland I A**, Peters T J. (1982) Isolation and fractionation of plasma lipoprotein classes by two phase counter current partition in poly(ethylene glycol)-dextran solutions. *Biochemical Society Transactions* **10**: 247.
7. Flanagan S D, Johansson G, Yost B, Ito Y, **Sutherland I A**. (1984) Toroidal coil countercurrent chromatography in the affinity partitioning of nicotinic cholinergic receptor enriched membranes. *Journal of Liquid Chromatography* **7**: 385–402.
8. **Heywood-Waddington D**, **Sutherland I A**, Morris W B, Peters T J. (1984) Subcellular fractionation of rat-liver homogenates using two-polymer phase systems in a toroidal coil centrifuge. *Biochemical Journal* **217**: 751–9.
9. **Sutherland I A**, **Heywood-Waddington D**, Peters T J. (1984) Toroidal coil chromatography: A fast simple alternative to countercurrent distribution using aqueous two-phase partition. *Journal of Liquid Chromatography* **7**: 363–84.
10. **Sutherland I A**. (1985) Countercurrent chromatography: Its application to the separation of viable biological material based on partition in aqueous two-phase polymer systems. *Chromatography International* **7**: 11–15.

11. **Sutherland I A, Heywood-Waddington D, Peters T J.** (1985) Countercurrent chromatography using a toroidal coil planet centrifuge: A comparative study of the separation of organelles using aqueous two-phase partition. *Journal of Liquid Chromatography* **8**: 2315–36.
12. **Heywood-Waddington D, Peters T J, Sutherland I A.** (1986) Partitioning behaviour of rat liver organelles in aqueous 2-polymer phase systems – effects of partitioning time, phase volumes and degree of mixing. *Biochemical Journal* **235**: 245–9.
13. **Sutherland I A.** (1986) Counter-current chromatography: A possible alternative to preparative HPLC. *The Chromatographic Society Bulletin* **21**: 8–9.
14. **Sutherland I A.** (1987) Countercurrent chromatography. *Laboratory Practice February 1987*: 37–42.
15. **Sutherland I A, Heywood-Waddington D, Ito Y.** (1987) Countercurrent chromatography: Applications to the separation of biopolymers, organelles and cells using either aqueous-organic or aqueous-aqueous phase systems. *Journal of Chromatography* **384**: 197–207.
16. **Heywood-Waddington D, Sutherland I A, Peters T J.** (1988) Sub-fractionation of rat liver microsomes by two-polymer phase partition in a toroidal coil centrifuge. *Biochemical Society Transactions* **16**: 34–5.

Glovebox Facility that flew on USML1, the Shuttle MidDeck and Mir Space Station

1. **Sutherland I A, Wolff H S, Helmke H, Riesselmann W, Nagy M, Voeten E, Chassay R.** (1993) Glovebox in orbit. ESA/NASA glovebox: A versatile USML-1 experiment facility. *Spaceflight* **35**: 15–17.

Other NIMR

2. **Delderfield A J, Sutherland I A, Campbell P J.** (1978) Gas analysis of the atmosphere within sealed glass ampoules using a quadrupole mass spectrometer. *Journal of Biological Standardization* **6**: 331–8.

Biographical notes*

Sir Arnold Burgen

MD FRS FMedSci (b. 1922) qualified in medicine at the Middlesex Hospital, London, in 1945 where he worked until his appointment as Professor of Physiology at McGill University, Montreal in 1949. In 1962 he returned to the UK as Sheild Professor of Pharmacology and Fellow of Downing College at the University of Cambridge and in 1967 became the Honorary Director, MRC Molecular Pharmacology Unit. In 1971 he was appointed Director of the NIMR where he remained until 1982 when he returned to Cambridge as Master of Darwin College until 1989. His research focused on the structure and function of salivary glands. He was knighted in 1976. See Clayton and NIMR staff (2014), page 73.

Mr Geof Chambers

BSc CEng MIMechE (b. 1955) qualified in mechanical engineering in 1978 and was employed at the NIMR from 1978 to 1988. He worked alongside Frank Doré and Ian Sutherland on the mechanical design of an insulin pump as

part of an NIH grant – this was ultimately commercialized as the Nordisk Insulin Infuser. He also collaborated with Steve White and Professor Ian Sutherland in conjunction with Professor Howard Jacobs at St Mary's Hospital, London, on the successful use of pump therapy, using pulsatile LHRH delivery, for the treatment of infertility. In 1988 he moved to MediSense in Abingdon as a member of the development team for the first commercial biosensor 'ExacTech' for the measurement of blood glucose for diabetics. In 1998 MediSense was bought by Abbott Diabetes Care Ltd and he became part of the development team (which included consultants Steve White and Chris Bunn – both ex-NIMR) of a very high-volume manufacturing process for the 'Precision Xtra' blood glucose test strip. He is currently a member of the design team for 'Freestyle Libre' – a miniature wearable continuous glucose monitoring system which launched in 2015.

Sir Henry Dale

OM GBE CBE Kt FRS MA MD FRCP (1875–1968) studied at Trinity College Cambridge and St

* Contributors are asked to supply details; other entries are compiled from conventional biographical sources.

Bartholomew's Hospital, qualifying in medicine in 1902 and MD in 1909. After working at University College London, in 1904 he was appointed pharmacologist at the Wellcome Physiological Research Laboratories where he was Director from 1906 until 1914, when he was appointed Director of the Department of Biochemistry and Pharmacology at the NIMR. In 1928 he became the first Director of the NIMR, and in 1942 became Director of the Laboratories of the Royal Institution and Fullerian Professor of Chemistry, posts which he held until 1946. He was President of the Royal Society from 1940 to 1945. His research focused on the chemical transmission of nerve impulses, for which he was awarded the Nobel Prize in Physiology or Medicine, jointly with Otto Loewi, in 1936. See Feldberg (1970).

Mrs Rosemary de Rossi

(b. 1931) joined the Medical Research Council in Hampstead in 1949, working in the Division of Biological Standards. She moved to Mill Hill in 1950 and passed A-level chemistry, botany, and zoology at evening classes a year or so later. John Humphrey set up the new Division of Immunology in 1957 and she joined him as Head Technician. She served on the House Committee in the

1950s and was also chairman of the Head Technicians Committee. When John Humphrey departed to work at Hammersmith in 1975, she transferred to the Division of Parasitology. She was co-author on several papers between 1979 and 1986. She became Head Technician in 1987 and welcomed Tony Holder as Head of Division in 1988. She retired a year later.

Sir Charles Harington

KBE Kt FRS PhD MA HonDSC (1897–1972) studied Natural Sciences at Cambridge University then went to the University of Edinburgh, to the Department of Medical Chemistry and then the Department of Therapeutics, where he received his PhD in 1922. With research focusing on the internal secretions of the thyroid gland, he spent a year at the Rockefeller Institute in New York and subsequently was appointed Lecturer in the Department of Chemical Pathology at University College Hospital Medical School, London, becoming a Reader in Pathological Chemistry in 1928 and Professor in 1931, when he was also elected FRS. In 1942 he succeeded Sir Henry Dale as Director of the NIMR, where he remained until his retirement in 1962. See Himsworth and Pitt-Rivers (1972).

Mr Russell Higgins

BSc MSc (b. 1954) graduated in electronic engineering from the University College of North Wales in 1987, and obtained his MSc in computing at the University of Bradford in 1991. He worked at the NIMR as a summer secondment student from the Ministry of Defence (MoD) in both 1986 and 1987. After leaving the MoD in 1989, he worked at the NIMR as a Senior Research Officer and then as a Higher Professional Technology Officer (1989–1990) within the Electronics section in Ronan Cottage. After a spell working at the University of Bradford following his MSc, he worked at Oilgear Towler Ltd in Leeds as a real-time embedded software engineer for hydraulic control systems (1992–1997). He then worked with Science Systems plc. in Bristol and Reading as a Principal Analyst Programmer working in a variety of areas, including leading a team writing a facilities management database for both the House of Commons and the House of Lords at Westminster. Since 2000, he has worked as a Senior Consultant with Hewlett Packard Enterprise Services Ltd. in Reading and Bracknell as the EMEA Technical Lead for ITSM Service Desk Integration.

Mr Roger Hooper

(b. 1944) started at the NIMR in 1963, aged 19, and worked in the instrument workshop.

Mr Jonathan Marsh

(b. 1942) left Hendon County Grammar School in 1960 and started at the NIMR on 8 August as a Junior Technician in the Division of Chemotherapy. He was allocated to work with Neil Brown. The Head of Department was Dr Hawking. When his A-level results were announced, botany, zoology, and chemistry, he was transferred to the Junior Technical Officer Grade. He obtained a Higher National Certificate in Applied Biology at Brunel College of Advanced Technology in 1964, which also gave 'licentiate' membership of the Institute of Biology. In Chemotherapy he worked on variation in the antigenic properties of trypanosomes for Neil Brown. He transferred to the Electronics Section of the Engineering Department in 1965 and worked with John Lewin, who ran the section with responsibility for the provision of bespoke electronic instrumentation needed in the NIMR. He obtained a Higher National Certificate in Electronics and Electrical Engineering at Hendon College in 1969. He worked with John Lewin until 1975, when Lewin left to join

the computing section. With Lewin he developed the apnoea alarm, the planimeter, worked for Griffith Pugh on instrumentation for monitoring the athletes at the Mexico Olympic Games in 1968, and fulfilled very many other requirements for NIMR research programmes. He then worked with Mike Anson mainly on instrumentation for the audiometer and stopped flow circular dichroism and temperature jump as well as being Head Technician and running the section. During this time his section provided the electronics for the insulin infuser among many other items. He became Head of the Department of Engineering in 1994 and retired from the NIMR in 2002. He was also sometime chairman of the NIMR LJNCC and chairman of the Safety Committee and a member of the MRC Pay and Grading Committee. He was NIMROD social secretary for some time and for many years ran the annual children's party. He also chaired the MRC Staff Benevolent Fund Association for 15 years and remains a committee member.

Mr Ian Mathison

(b. 1932) matriculated in 1949/50 and did A-levels in botany, zoology, and chemistry. Between 1951 and 1953 he did National Service, including a year in the

Korean War. In late 1953 he was appointed to the NIMR as an apprentice technician in the Bacterial Chemistry Division (later Bacterial Physiology and then Microbiology). In September 1970 he was appointed as Head Technician to set up and run two new Divisions, Genetics and Developmental Biology, which were to occupy new laboratories on the fifth and sixth floors. In 1972 he served on the Director's Laboratory Planning Committee. He became Senior Chief Technician in 1972 and Higher Scientific Officer in 1989. He was a Fire Warden, Stores Advisory Committee Secretary, and Union Safety Representative (MSF), and was first aid qualified from 1964 until his retirement in 1993.

Sir Peter Medawar

OM CH Kt CBE MA DSc FRS HonFBA (1915–1987) studied zoology at Oxford University, graduating in 1935. After Fellowships at Oxford, in 1947 he was appointed Mason Professor of Zoology at the University of Birmingham. From 1951 until 1962 he was Jodrell Professor of Zoology at University College London, after which he succeeded Sir Charles Harington as Director of the NIMR. He retired from this post in 1971 following a stroke, and became head of the

new Transplantation Biology Department at the Clinical Research Centre, Harrow, until 1986. His research on transplantation and immunological tolerance led to his being awarded the Nobel Prize in Physiology or Medicine in 1960, jointly with Sir Frank Macfarlane Burnet. See Mitchison (1990).

Mrs Hilary Morgan

(b. 1935) left school in 1953 and worked for ICI in the Plant Pathology laboratory in Welwyn. From 1957 to 1959, she was Junior Technician, later Junior Technical Officer, in the Biochemistry Division of the NIMR at Mill Hill with Dr Rodney Porter during the time of his early work on the structure of immunoglobulin. She then worked at British Drug Houses, Islington, in the research section of the Hormone Production Department from 1959 to 1961. She returned to Mill Hill, this time at the laboratories of the Imperial Cancer Research Fund, Virology Division, working for Dr Gavino Negróni on human leukaemia. During this time she obtained the Associateship of the Institute of Science Technology and, in 1973, obtained the Fellowship of the Institute by dissertation – ‘Methods and Techniques used in Biological and Biochemical Studies of a Mycoplasma Isolated from

Leukaemic Patients’. In 1974 she returned to the NIMR as Head Technician in the Laboratory for Leprosy and Mycobacterial Research. Initially this was with Dr R J W (Dick) Rees and then, following his retirement, with Dr Jo Colston. During this period she was also involved with WHO and LEPRO and worked in India on several occasions. She retired in 1995.

Dr Peter J T Morris

MA DPhil FRSC FRAS (b. 1956) is a Research Fellow Emeritus in the Research & Public History Department at the Science Museum, London, having previously been Principal Curator of Science and Keeper of Research Projects, and an Honorary Research Associate of the Science and Technology Studies Department of UCL. He has published books on the history of polymers, modern chemical instrumentation, and Robert Burns Woodward. He was editor of *Ambix*, the journal of the Society for the History of Alchemy and Chemistry, between 2001 and 2012. His most recent work is *The Matter Factory: A history of the chemistry laboratory* (Morris, 2015). Morris was given the Edelstein Award for lifetime achievement in the history of chemistry by the American Chemical Society in 2006 and the Wheeler Award for

his outstanding contribution to the history of chemistry by the Royal Society of Chemistry in 2013.

Dr Andrew Pinder

MA PhD CEng MIET CPhys MInstP FRSA (b. 1953) graduated in physics from the University of Oxford in 1974. After a short period in industry, he joined the scientific staff of the Engineering Department at the NIMR in 1978, where he worked on projects ranging from eardrum vibration measurement to high-speed cell sorting and laser spectroscopy, obtaining a PhD (in collaboration with University College London) in 1983. He moved to the BBSRC Institute of Food Research in Norwich in 1985 as senior research leader of the laser and imaging group in the Biophysics Department. Increasingly drawn towards communicating science to the general public, he received awards for this work from the Royal Society, the British Association, and the British Council. In 1999, with the opportunity to produce a series on cell biology for BBC2 ('Cell City'), he finally left research and started his own production company. He has since made programmes for all four major UK broadcasters, together with Teachers' TV and many

government and corporate clients. In 2000 he received an RS/BA Millennium Fellowship.

Mr John Sawkins

(b. 1946) was apprenticed to Russell Wood Radio & TV Retailer in 1962. After receiving his City & Guilds qualifications in Radio, Television and Colour TV (1962–1968) he worked in the domestic Radio & TV sector from 1968 to 1981, receiving his City & Guilds Digital Logic Techniques qualification in 1980. In 1981 he joined the NIMR Engineering Department (Electronics Section), where he remained until his retirement in May 2011.

Sir John Skehel

Kt PhD FRS FMedSci (b. 1941) graduated in agricultural biochemistry at the University College of Wales, Aberystwyth, and was awarded his PhD at the University of Manchester in 1966. Following research at the University of Aberdeen and at Duke University, he joined the NIMR in 1969 and the permanent staff in 1971. He was Head of the Division of Virology from 1984 to 1987 and was Director of the NIMR from 1987 to 2006. He was head of the WHO Collaborating Centre for Reference and Research on Influenza at the NIMR between 1975 and 1993, and he has received

many awards for his pioneering research on influenza viruses, including the Willem Feldberg Prize (1986), the Robert Koch Prize (1987), the Royal Society's Royal Medal (2003), and the Grand Prix, Louis D Foundation of the Institut de France (2007). He was knighted in 1996. He is currently a Visiting Scientist at the NIMR. See Clayton and NIMR staff (2014), page 103, and the Royal Society website <https://royalsociety.org/people/john-skehel-12289/> (accessed 8 March 2016.)

Dr Jim Smith

PhD FRS FMedSci (b. 1954) was an undergraduate at Christ's College Cambridge and obtained his PhD from the Middlesex Hospital Medical School in 1979, where he studied chick limb development under the supervision of Lewis Wolpert. He did postdoctoral work with Chuck Stiles (Harvard Medical School) and with Jonathan Slack (Imperial Cancer Research Fund) before establishing his research group at the MRC National Institute for Medical Research in 1984. In 2000 Jim moved to Cambridge University to become Director of the Gurdon Institute before returning to NIMR in 2009 as Director. He took up his current role as Deputy Chief Executive and Chief of Strategy at the Medical

Research Council (MRC) in 2014, and his role as Director of Research at the Francis Crick Institute in 2015. A developmental biologist, he was elected to the Fellowship of the Royal Society in 1993 and made a Founder Fellow of the Academy of Medical Sciences in 1998. He is also a member of the European Molecular Biology Organisation (EMBO), a member of the Academia Europaea, and an Honorary Fellow of Christ's College Cambridge. He was awarded the Scientific Medal of the Zoological Society in 1989, the EMBO medal in 1994, the Feldberg Foundation Award in 2000, and the Waddington Medal of the British Society for Developmental Biology (BSDB) in 2013.

Professor Ian Sutherland

BSc PhD CEng FIMechE FIPEM (b. 1945) graduated in mechanical engineering in 1967 from Bristol University and, after a graduate apprenticeship in the machine tool industry, returned to Bristol to do a PhD in machine tool technology. He then joined NASA as a National Academy of Sciences postdoctoral research fellow at the George C Marshall Space Flight Center, Huntsville, Alabama, before returning to the UK to join the MRC's National Institute for Medical Research as a member of

their scientific staff and Head of Mechanical Engineering. In 1989 he moved to Brunel University's Institute for Bioengineering, where he was director from 1995 to 2010. He founded the Advanced Bioprocessing Centre at Brunel in 2006, where he and his team developed new methods of purifying drugs and getting them to market quickly in close collaboration with the pharmaceutical industry. He retired in 2012 and now has part-time appointments in both Brunel University London and Sichuan University, Chengdu, China. In 2004 he was invited to give the IMechE James Clayton Lecture, and was awarded a visiting professorship at Sichuan University in China in 2005 and a guest professorship there in 2015. Professor Sutherland is currently on the IMechE Pharmaceutical Committee, a board member of the Biomedical Engineering Association (BmEA), and an Executive Council Member of the Consortium for the Globalisation of Chinese Medicine (CGCM).

Professor Tilli Tansey

OBE PhD PhD DSc HonMD
 HonFRCP FMedSci (b. 1953)
 graduated in zoology from the University of Sheffield in 1974, and obtained her PhD in *Octopus* neurochemistry in 1978. She

worked as a neuroscientist in the Stazione Zoologica Naples, the Marine Laboratory in Plymouth, the MRC Brain Metabolism Unit, Edinburgh, and was a Multiple Sclerosis Society Research Fellow at St Thomas' Hospital, London (1983–1986). After a short sabbatical break at the Wellcome Institute for the History of Medicine (WIHM), she took a second PhD in medical history on the career of Sir Henry Dale, and became a member of the academic staff of the WIHM, later the Wellcome Trust Centre for the History of Medicine at UCL. She became Professor of the History of Modern Medical Sciences at UCL in 2007 and moved to Queen Mary, University of London (QMUL), with the same title, in 2010. With the late Sir Christopher Booth she created the History of Twentieth Century Medicine Group in the early 1990s, now the History of Modern Biomedicine Research Group at QMUL. She is an Honorary Fellow of the Society of Apothecaries' Faculty of the History of Medicine; an Honorary Member of the Physiological Society, of which she is also Honorary Archivist, and recipient of the Paton Prize in History of Physiology, 2015.

Dr Anthony Travis

PhD (b. 1943), received the HNC in chemistry from Borough Polytechnic, graduated in chemistry from Birkbeck College, University of London, in 1970, and obtained his PhD in synthesis and photochemistry of carbohydrate derivatives in 1978. After almost two decades in the textile and printing industries he joined the teaching profession in the London Borough of Brent in 1980, and contributed towards curriculum development. He was appointed deputy director of the Sidney M Edelstein Center for the History and Philosophy of Science, Technology and Medicine at The Hebrew University of Jerusalem in 1988. He has published extensively on the history of chemical technology in the nineteenth and twentieth centuries. Publications include: *The Rainbow Makers: The originals of the synthetic dyestuffs industry in Western Europe* (1993); (with Carsten Reinhardt) *Heinrich Caro and the Creation of Modern Chemical Industry* (2000); *Dyes Made in America, 1915–1980: The Calco Chemical Company, American Cyanamid, and the Raritan River* (2004); and *The Synthetic Nitrogen Industry in World War I: Its emergence and expansion* (2015). Currently he is undertaking research into industrial nitrogen

fixation, and the life of the British chemist and Darwinian, Raphael Meldola. Travis is the recipient of four awards for his contributions to the history of chemistry and chemical technology.

Mr Peter Turner

(b. 1949) joined the MRC Molecular Pharmacology Unit (Director Arnold Burgen) in Cambridge 1970, and moved to the Division of Molecular Pharmacology at the NIMR in August 1972 as a Junior Technical Officer. He worked on various research projects with Rod King, and was promoted over the years to Senior Technical Officer (later renamed Research Officer). In 1987 he moved to the Division of Developmental Biology, working under Jam Tata as his Head Technician, and then, in 1989, to the Division of Parasitology as Head Technician under its new head, Tony Holder. He moved again in 1992 to be Group Head Technician of the divisions of Physical Biochemistry, Peptide and Lipid Chemistry and Protein Structure under the overall headship of David Trentham. In 1996 he left the NIMR to help establish the new MRC Prion Research Unit under John Collinge as his Laboratory and Business Manager. He took early retirement in late 2006 but continued to work

on a part-time consultancy basis for the Prion Unit until the end of 2010.

Mr Steven White

BSc, MSc, MIET, CEng (b. 1955) graduated in electronics from Chelsea College, University of London, followed by an MSc in Biophysics & Bioengineering, again from Chelsea College (1984). He worked as executive engineer on sonobuoys and radio security equipment at EMI systems and weapons division (1978–1980); Research Assistant at the NIMR (1980–1985); Technical Development engineer at Lasersharp Ltd on scanning confocal microscopes (1985–1986); Development Engineer working on heart bypass blood gas equipment at Biomedical Sensors Ltd (1986–1988); Research Assistant working on X-ray stereophotogrammetry applied to hip joint loosening research at Oxford Orthopaedic Engineering Centre, part of the University of Oxford Engineering Department (1988–1991); and Managing Director of his own consultancy company for 22 years, Trace Instruments Ltd (1990–2012). He was Chief Engineer, for three years, at Oxford Nanopore Technologies. This was followed by working as Principal Engineer at the same company (2005–present)

working on the design of a low-noise silicon chip instrument for next generation DNA sequencing.

Professor Heinz Wolff

BSc HonDSc HonFRCP FSB FIET (b. 1928) came to England from Germany in 1939. Having gained a place at Oxford University, he postponed his degree, working as a technician in the Department of Haematology at the Radcliffe Infirmary in Oxford and at the Pneumoconiosis Research Unit at Llandough Hospital near Cardiff. He graduated in physiology and physics from UCL in 1954 and went to work in the Division of Human Physiology at the NIMR. In 1962 he founded the Division of Biomedical Engineering, of which he was Head until 1970 when he became Head of the Bioengineering Division of the MRC's Clinical Research Centre. In 1983 he founded the Institute for Bioengineering at Brunel University, where he was Director until 1995, and is currently Emeritus Professor of Bioengineering. Wolff is also known for his television and radio work, including *BBC Young Scientist of the Year* and *The Great Egg Race*. See www.nmplive.co.uk/professor-heinz-wolff (accessed 8 March 2016).

References*

- Adlard E. R. (2003) 50 Years of gas chromatography. *Chromatographia* **57**: S13–S18.
- Aker F. (1984) Heinz Wolff: A technology buff. *New Scientist* 10 May, 47–8.
- Anon. (1966) Northwick Park Hospital and Clinical Research Centre. *British Medical Journal* **i**: 535–7.
- Anon. (1970a) Northwick Park Hospital and Clinical Research Centre. I. Plans and practice. *British Medical Journal* **iii**: 576–7.
- Anon. (1970b) Northwick Park Hospital and Clinical Research Centre. II. Architectural solutions. *British Medical Journal* **iii**: 577–80.
- Anon. [P J W] (1986) F Hawking. *British Medical Journal* **293**: 455.
- Anon. (1989) Otto Gustaf Edholm. *Lives of the Fellows of the Royal College of Physicians* **8**: 141–3.
- Anon. (2013/2014) In memoriam. James Lightbown (1918–2013). *MRC Annual Report and Prospectus*, available online at <https://www.crick.ac.uk/media/224871/nimrannrep2013-14.pdf> (accessed 16 November 2015).
- Askonas B. (1990) John Herbert Humphrey. 16 December 1915 – 25 December 1987. *Biographical Memoirs of the Fellows of the Royal Society* **36**: 274–300.
- Baker J A, Humphrey S J, Wolff H S. (1967) Socially acceptable monitoring instruments (SAMI). *Journal of Physiology* **188**: 4P–5P.
- Bangham D R. (1999) *A History of Biological Standardization: The characterization and measurement of biological standards: contributions from the UK 1900–1995: what, why, how, where and by whom: a personal account*. Bristol: Society for Endocrinology.
- Berthod A, Sutherland I. (2001) CCC 2000 – First International Conference on Countercurrent Chromatography, a cornerstone for the technique. *Journal of Liquid Chromatography & Related Technologies* **24**: 1523–32.

* Please note that references with four or more authors are cited using the first three names followed by 'et al.'. References with 'et al.' are organized in chronological order, not by second author, so as to be easily identifiable from the footnotes.

- Black S. (1963) Inhibition of immediate-type hypersensitivity response by direct suggestion under hypnosis. *British Medical Journal* **i**: 925–9.
- Black S, Friedman M. (1965) Adrenal function and the inhibition of allergic responses under hypnosis. *British Medical Journal* **i**: 562–7.
- Boer H. (1979) In Ettre L S, Zlatkis A. (eds) *75 Years of Chromatography*. Amsterdam: Elsevier, 11–19.
- Booth C C. (1986) The Stoker Report and the future of Northwick Park. *Lancet* **i**: 372–4.
- Born G V R, Weatherall D J. (1990) Robert Gwyn Macfarlane. 26 June 1907–26 March 1987. *Biographical Memoirs of Fellows of the Royal Society* **35**: 210–45.
- Brent L. (2009) Sir Peter Medawar's years as director of NIMR: a vignette. *Mill Hill Essays*, available online at www.historyofnimr.org.uk/mill-hill-essays/essays-yearly-volumes/2009-2/sir-peter-medawars-years-as-director-of-nimr-a-vignette/ (accessed 2 February 2016).
- Burke D. (2010) *TSR2 – Britain's Lost Bomber*. Ramsbury, Wilts: The Crowood Press Ltd.
- Carson R. (1962) *Silent Spring*. Boston: Houghton Mifflin; (1963) London: Hamish Hamilton.
- Cerruti L. (2002) The impact of chromatographic and electrophoretic techniques on biochemistry and the life sciences. In Morris P J T. (ed.) *From Classical to Modern Chemistry: The instrumental revolution*. London: Royal Society of Chemistry/Science Museum, 309–32.
- Chambers G R, Sutherland I A, White S *et al.* (1984) A new generation of pulsatile infusion devices. *Upsala Journal of Medical Sciences* **89**: 91–5.
- Clayton J, NIMR staff. (2014) *A Century of Science for Health*, [Mill Hill]: MRC National Institute for Medical Research, available online at www.historyofnimr.org.uk (accessed 25 April 2016).
- Dobbs E R. (1972) The organisation and control of scientific research by the United Kingdom Government. *Higher Education* **1**: 345–55.
- Feldberg W S. (1970) Henry Hallett Dale. 1875–1968. *Biographical Memoirs of the Fellows of the Royal Society* **16**: 77–174.

- First International Congress of Biochemistry. (1950) *First International Congress of Biochemistry, held at Cambridge 19–25 August 1949. Report of Opening & Concluding Sessions and Three Lectures Delivered to the Congress*. Glasgow: Biochemical Society.
- Fleming G R, Phillips D. (2004) George Porter KT OM, Lord Porter of Luddenham. 6 December 1920 – 31 August 2002. *Biographical Memoirs of Fellows of the Royal Society* **50**: 257–83.
- Fletcher J G, Wolff H S. (1954) A lightweight integrating motor pneumotachograph (i.m.p.) with constant low resistance. *Journal of Physiology* **123**: 67P–69P.
- Galison P. (1997) *Image and Logic: A material culture of microphysics*. Chicago: University of Chicago Press.
- Goodwin E S, Goulden R, Richardson A *et al.* (1960) The analysis of crop extracts for traces of chlorinated pesticides by gas-liquid partition chromatography. *Chemistry and Industry* **24**: 1220–21.
- Great Britain, Parliament. (1971) *A Framework for Government Research and Development*. London: HMSO.
- Gregory N L. (1961) The Passage of Slow Electrons through Mixtures of Gases Applied to the Study of the Physical Nature of Chemical Bonds. MSc dissertation, University of London (External Department).
- Gurr M. (2012) Anthony Trafford James: 6 March 1922 – 7 December 2006. *Biographical Memoirs of Fellows of the Royal Society* **58**: 129–50.
- Hartley J M, Tansey E M. (2015) White coats and no trousers: narrating the experiences of women technicians in medical laboratories, 1930–90. *Notes & Records of the Royal Society of London* **69**: 25–36.
- Heywood-Waddington D, Peters T J, Sutherland I A. (1986) The dynamics of phase partition. A study of parameters affecting rat liver organelle partitioning in aqueous two-polymer phase systems. *Biochemical Journal* **235**: 245–9.
- Heywood-Waddington D, Sutherland I A, Morris W B *et al.* (1984) Subcellular fractionation of rat liver homogenates using two-polymer phase systems in a toroidal-coil centrifuge. *Biochemical Journal* **217**: 751–9.

- Himsworth H, Rosalind Pitt-Rivers R. (1972) Charles Robert Harington. 1897–1972. *Biographical Memoirs of the Fellows of the Royal Society* **18**: 266–308.
- Holloman B. (2014) Robin Holliday 1932–2014. *Cell* **157**: 1001–3.
- Holman T. (1992) *Airmen Anonymous*. Merlin Books, Braunton Devon.
- Homburg R, Eshel A, Armar N A *et al.* (1989) One hundred pregnancies after treatment with pulsatile luteinising hormone releasing hormone to induce ovulation. *British Medical Journal* **298**: 809–12.
- Ignatova S, Sutherland I. (2015) The 8th International Conference on Countercurrent Chromatography held at Brunel University, London, UK, July 23–25, 2014, *Journal of Chromatography A*, <http://dx.doi.org/10.1016/j.chroma.2015.10.096> (accessed 16 November 2015).
- Ito Y, Bowman R L. (1970) Countercurrent chromatography: liquid-liquid partition chromatography without solid support. *Science* **167**: 281–3.
- Ito Y, Harada R, Weinstein M A *et al.* (1966) The coil planet centrifuge. *Nature* **212**: 985–7.
- Jacobs H S, Adams J, Franks S *et al.* (1984) Induction of ovulation with LHRH – problems, indications and contra indications. *Journal of Steroid Biochemistry and Molecular Biology* **20**: 1382.
- James A T. (1956) Gas-liquid chromatography: separation and microestimation of volatile aromatic amines. *Analytical Chemistry* **28**: 1564–7.
- James A T. [1957] Analysis in chemical research. In *Proceedings of the Congress on Modern Analytical Chemistry in Industry, held at the University of St. Andrews, June 24th to 28th, 1957*. Cambridge: W. Heffer & Sons (for the Society of Analytical Chemistry), 109–18.
- James A T. (1977) The invention of gas-liquid chromatography. *Trends in Biochemical Sciences (TIBS)* **2**: N243–6.
- James A T. (1979) This week's citation classic. *CC [Column Chromatography]*, no. 33, 13 August, 45.
- James T. [A T] (1995) Development of gas-liquid chromatography: A personal memoir by A. T. James. *INFORM* **6**: 820–34. Also available in *AOCS Lipid Library*.

- James A T, Martin A J P. (1951) Liquid-gas partition chromatography. *Biochemical Journal. Proceedings of the Biochemical Society* **48**: vii.
- James A T, Martin A J P. (1952) Gas-liquid partition chromatography: The separation and micro-estimation of volatile fatty acids from formic acid to dodecanoic acid. *Biochemical Journal* **50**: 679–90.
- James A T, Piper E A. (1961) Automatic recording of the radioactivity of zones eluted from the gas-liquid chromatogram. *Journal of Chromatography* **5**: 265–70.
- James A T, Lovelock J E, Piper E A. (1959) A new type of ionization detector for gas chromatography. *Annals of the New York Academy of Sciences* **72**: 720–30.
- Lack C H, Rodgers H J. (1958) Action of plasmin on cartilage. *Nature* **182**: 948–9.
- Lewin J E. (1969) An apnoea-alarm mattress. *Lancet* **ii**: 667–8.
- Lightbown J W, Newland P, Sutherland I A *et al.* (1977) Analysis of candicidin and related polyene antibiotics by means of the coil planet centrifuge. *Proceedings of the Analytical Division of the Chemical Society* **14**: 34–7.
- Lovelock J. (1958) A sensitive detector for chromatography. *Journal of Chromatography* **1**: 35–46.
- Lovelock J. (1997) Midwife to the greens: The electron capture detector. *Microbiologia* **13**: 11–22.
- MacIntosh F C, Paton W D M. (1974) George Lindor Brown. 1903–1971. *Biographical Memoirs of Fellows of the Royal Society* **20**: 41–73.
- Martin A J P. [written by another] (1969) Historical background. In Porter R (ed.) *Gas Chromatography in Biology and Medicine (CIBA Foundation Symposium, London, February 5–6, 1969)*. London: J & A Churchill, 2–10.
- Martin A J P, James A T. (1956) Gas-liquid chromatography: The gas-density meter, a new apparatus for the detection of vapours in flowing gas streams. *Biochemical Journal* **63**: 138–43.
- Mason P, Adams J, Morris D V *et al.* (1984) Induction of ovulation using pulsatile luteinising hormone releasing hormone. *British Medical Journal* **288**: 181–5.
- Medawar P. (1963) Is the scientific paper a fraud? *Listener* **70**: 377–8.

- Mitchison N A. (1990) Peter Brian Medawar. 28 February 1915 – 2 October 1987. *Biographical Memoirs of the Fellows of the Royal Society* **35**: 282–301.
- Morrell J M, Keeler K D, Noakes D E *et al.* (1988) Sexing of sperm by flow cytometry. *Veterinary Record* **122**: 322–4.
- Morris P J T. (2002) ‘Parts per trillion is a fairy tale’: The development of the electron capture detector and its impact on the monitoring of DDT. In Morris P J T. (ed.) *From Classical to Modern Chemistry: The instrumental revolution*. London: Royal Society of Chemistry/Science Museum, 259–84.
- Morris P J T. (2008) Martin, Archer John Porter. *Complete Dictionary of Scientific Biography*, online at www.encyclopedia.com/topic/Archer_John_Porter_Martin.aspx (accessed 17 November 2015).
- Morris P J T. (2010) Regional styles in pesticide analysis: Coulson, Lovelock, and the detection of organochlorine insecticides. In Morris P J T, Staubermann K. (eds) *Illuminating Instruments. Artefacts: Studies in the history of science and technology*, Vol. 7. Washington DC: Smithsonian Institution Scholarly Press, 53–69.
- Morris P J T. (2015) *The Matter Laboratory: A history of the chemistry laboratory*. London: Reaktion Books.
- Morris P J T, Ettore L S. (2007) The saga of the electron-capture detector. *LCGC North America* **25**: 164–78. Reprinted: The development of the electron capture detector. In Ettore L S, Hinshaw J V. (eds) (2008) *Chapters in the Evolution of Chromatography*. London: Imperial College Press, 321–36.
- Ness A R, Reynolds L A, Tansey E M. (eds)(2002) *Population-based Research in South Wales: The MRC Pneumoconiosis Research Unit and the MRC Epidemiology Unit*. Wellcome Witnesses to Twentieth Century Medicine, vol. 13. London: The Wellcome Trust Centre for the History of Medicine at UCL, available online at <http://www.histmodbiomed.org/witsem/vol13> (accessed 22 June 2015).
- Parkes A S. (1953) Prevention of fertilization by a hyaluronidase inhibitor. *Lancet* **265**: 1285–7.
- Parkes A S. (1985) *Off-beat Biologist*. Cambridge: The Galton Foundation.
- Pearson J M, Rees R J, Waters M F. (1975) Sulphone resistance in leprosy. A review of one hundred proven clinical cases. *Lancet* **ii**: 69–72.

- Perry S V. (1987) Rodney Robert Porter. 8 October 1917 – 6 September 1985. *Biographical Memoirs of the Fellows of the Royal Society* **33**: 445–89.
- Perutz M. (1989) *Is Science Necessary? Essays on science and scientists*. London: Barrie & Jenkins Ltd.
- Pinder A C, Palmer A R. (1982) A novel optical technique for measuring small vibrations. *Journal of Physics E: Scientific Instruments* **15**: 478–84.
- Pinder A C, Palmer A R. (1983) Mechanical properties of the frog ear: vibration measurements under free- and closed-field acoustic conditions. *Proceedings of the Royal Society of London B* **219**: 371–96.
- Pugh L G. (1967) Athletes at altitude. *Journal of Physiology* **192**: 619–46.
- Rasmussen N. (2002) Innovation in chemical separation and detection instruments: Reflections on the rôle of research-technology in the history of science. In Morris P J T. (ed.) *From Classical to Modern Chemistry: The instrumental revolution*. London: Royal Society of Chemistry/Science Museum, 251–8.
- Reinhardt C. (2006) *Shifting and Rearranging: Physical methods and the transformation of organic chemistry*. Sagamore Beach: Science History Publications.
- Reynolds L A, Tansey E M. (eds) (2000) *Clinical Research in Britain, 1950–1980*. Wellcome Witnesses to Twentieth Century Medicine, vol. 7. London: The Wellcome Trust, available online at www.histmodbiomed.org/witsem/vol7 (accessed 27 May 2015).
- Reynolds L A, Tansey E M. (eds) (2005) *The Recent History of Platelets in Thrombosis and other Disorders*. Wellcome Witnesses to Twentieth Century Medicine, vol. 23. London: The Wellcome Trust Centre for the History of Medicine at UCL, available online at www.histmodbiomed.org/witsem/vol23 (accessed 21 December 2015).
- Reynolds L A, Tansey E M. (eds) (2011) *History of British Intensive Care, c. 1950–c.2000*. Wellcome Witnesses to Twentieth Century Medicine, vol. 42. London: School of History, Queen Mary University of London, available online at www.histmodbiomed.org/witsem/vol42 (accessed 21 December 2015).

- Rosen J D, Gretch F M. (1987) Analytical chemistry of pesticides: Evolution and impact. In Marco G J, Hollingsworth R M, Durham W. (eds) *Silent Spring Revisited*. Washington DC: American Chemical Society, 127–143.
- Rothwell D, Sutherland I A, Parsons J A. (1981) A new miniature insulin infuser (Abstract). *Diabetologia* **21**: 321–2.
- Rothwell D, Sutherland I A, Pickup J C *et al.* (1983) A new miniature, open-loop, extracorporeal insulin infusion pump. *Journal of Biomedical Engineering* **5**: 178–84.
- Sansarricq H. (2004) *Multidrug Therapy against Leprosy: Development and implementation over the past 25 years*. Geneva: World Health Organization; available online at www.who.int/lep/resources/MDT_Full.pdf (accessed 21 October 2015).
- Smelt A H, Liew F Y, Rees R J. (1978) Lymphocyte response of leprosy patients to human-derived and purified armadillo-derived *Mycobacterium leprae*, BCG and PPD. *Clinical and Experimental Immunology* **34**: 164–9.
- Tansey E M. (1995) An F4-vescent episode: Sir Henry Dale's laboratory 1919–1942. The first W D M Paton memorial lecture. *British Journal of Pharmacology* **115**: 1339–45.
- Tansey E M. (2008a) Keeping the culture alive: the laboratory technician in mid-twentieth-century British medical research. *Notes & Records of the Royal Society of London* **62**: 77–95.
- Tansey E M. (2008b) Working with C. S. Sherrington, 1918–24. *Notes & Records of the Royal Society of London* **62**: 123–30.
- Tansey E M. (2008c) Working with Cambridge physiologists. *Notes & Records of the Royal Society of London* **62**: 131–7.
- Tansey E M. (2009) Philip Montague D'Arcy Hart. *Munk's Roll* **12**: online at <http://munksroll.rcplondon.ac.uk/Biography/Details/5505> (accessed 2 December 2015).
- Tansey E M, Christie D A. (eds) (1999) *Haemophilia: Recent history of clinical management*. Wellcome Witnesses to Twentieth Century Medicine, vol. 4. London: The Wellcome Trust, available online at www.histmodbiomed.org/witsem/vol4 (accessed 21 December 2015).

- Tansey E M, Christie D A, Reynolds L A. (eds) (1998) The MRC Common Cold Unit. *Wellcome Witnesses to Twentieth Century Medicine*, vol. 2. London: The Wellcome Trust, 209–68, available online at www.histmodbiomed.org/witsem/vol2 (accessed 21 December 2015).
- Tansey E M, Catterall P P, Christie D A *et al.* (eds) (1997) Technology Transfer in Britain: The case of monoclonal antibodies. *Wellcome Witnesses to Twentieth Century Medicine*, vol. 1. London: The Wellcome Trust, 1–34, available online at www.histmodbiomed.org/witsem/vol1 (accessed 21 December 2015).
- Travis A S. (2002) Instrumentation in environmental analysis, 1935–1975. In Morris P J T. (ed.) *From Classical to Modern Chemistry: The instrumental revolution*. London: Royal Society of Chemistry/Science Museum, 285–308.
- Travis A S. (2012) Detecting chlorinated hydrocarbon residues: Rachel Carson's villains. *Ambix* **59**: 109–30.
- Tuckey H. (2013) *Everest – The First Ascent: The untold story of Griffith Pugh, the man who made it possible*. London: Rider.
- Walker C H. (1966) Some chemical aspects of residue studies with DDT. *Journal of Applied Ecology* **3**: 213–22.
- Watson J D, Crick F H C. (1953) A structure for deoxyribose nucleic acid. *Nature* **171**: 737–8.
- Wolff H S. (1961) The radio pill. *New Scientist* **261**: 419–21.
- [Wolff H]. (2001) Martin Wright. *The Times* (23 March), 25.
- Wright C M. (2001) Basil Martin Wright. *British Medical Journal* **322**: 1308.

Index: Subject

Pages numbers in *italics* refer to illustrations.

- academic freedom xix, 51–2, 68, 70, 158
- accidents
 chromic acid spills 25, 27, 28
 electrical 39
 falls due to slippery floors 27–8
 fires 30, 39
 floods 38
 flying chuck keys 109
 out-of-hours 43
 recording 28
 stuck in lifts 111, 112
- Aden 7
- administration 15, 34, 99–100
 ordering systems 34, 100–1, 104–5
- albumen, radioactive 25–6
- alchemical labs 129, 129, 130
- altitude research 12, 13
- Amersham (Radiochemical Centre)
 25, 26
- Aminco Press 171
- analytical chemistry 67, 151–70
see also chromatography;
 electrophoresis
- animal experimentation
 demonstrations against 122
 depilation of guinea pigs 107
 draining lymph from pigs 66–7
 escaped mice 112
 escaped monkeys 23–4
 facilities 24, 26, 38, 66, 120
 legislation 26
 leprosy 101, 102
 low temperatures 165–6
 radioactive albumen 25–6
 sperm sorting in cattle 68
 turkeys as blood donors 120
 vaccines 23, 25, 102
- antibiotic resistance 75, 97
- antibiotic standards 21, 42
- apnoea alarms 12, 70, 91–3
- Apothecaries' Hall 133
- argon-ionizing detectors 153, 165, 166, 168, 170
- armed forces
 National Service 9, 21, 154
 research on behalf of 7, 9
 war service 61, 116, 157
- army surplus equipment 102–4, 118, 159–60
- Association of Scientific Workers (AScW) (later ASTMS) 116–17
- athletics, at altitude 12
- Bacterial Chemistry Division (latterly Microbiology) 24–5, 38, 75, 84, 97, 97, 111
- BBC computers 59, 60, 145, 146
- benches
 improved design 39, 136
 teak 15, 25, 30, 37, 105–6
- Benchkote 30
- biochemistry, as a discipline 156
- bioengineering 5–6, 9
- Biological Standards Division 21, 42, 106–7
- Biophysics Department 146, 159
- Biotechnology and Biological Sciences Research Council (BBSRC) 68, 72
- blood donation 120
- blood flow monitors 93, 94
- Blue Streak missile 103
- 'break-away' companies *see* commercialization of technology
- breathalysers 20, 55

- British Technology Group (BTG) 98
- Brunel University 45
 - as Brunel College of Technology (Acton) 17, 18
- Bunsen burners 39, 133
- canteens 6, 10–11, 15–16, 38, 69, 76
- career trajectories 32, 107, 110–11, 154, 157–8
- catering
 - for Christmas parties 75, 77, 119–20
 - Hampstead site 6
 - Mellanby Building 75
 - Mill Hill main building 10–11, 15–16, 38, 69
 - social club 76
- cattle 68
- cell counting 8, 33
- cell wall preparation 97, 98, 171
- centrifuges for countercurrent
 - chromatography 41–2, 43–4, 44–5, 174–6
- Century of Science for Health* (Clayton) xvii
- chemical analysis 67, 151–70
 - see also* chromatography; electrophoresis
- chemical museums 134–5
- chemicals, make-your-own 25, 28
- chemistry laboratories, history 36, 129–38
 - 1930s style 130, 131
 - alchemical labs 129, 129, 130
 - Lavoisier's (1790s) 131, 132
 - Liebig's (1840s) 131, 132
 - see also* laboratory design
- Chemotherapy Division (latterly Parasitology) 12, 19, 33, 75, 107–8
- chickens 25–6, 119
- children's parties 76–7, 77–8, 83–4
- China 42, 45
- chloroform 42
- Christmas parties 75, 76–8, 83–4, 119
- Christmas presents 117
- chromatography 155
 - fraction collectors 21–3, 23, 127
 - gas 64–5, 149, 151, 156, 158, 160–70
 - liquid-liquid (countercurrent) 41–2, 43–4, 44–5, 70, 174–6
- chromic acid 25, 26, 27, 28
- chuck keys 109
- climatic chambers 7
- climbing *see* mountaineering
- Clinical Research Centre (Northwick Park) 6, 72
- cobalt-60 source 115
- coffee rooms 11, 75
- coiled planet centrifuges 41–2, 43
- Columbia space shuttle 44
- commercial companies
 - relationships with 26, 105, 117
 - research laboratories 135–6, 135, 136–7
 - set up by NIMR employees 22–3, 50
- commercialization of technology 50–1, 72, 93, 98–9
 - apnoea alarms 92
 - countercurrent chromatography 45
 - fraction collectors 22–3
 - gas density meters 163
 - glucose monitors 60
 - insulin pumps 56, 56, 98
 - LHRH pumps 69–70
 - peristaltic pumps 63
- computers 47–8, 57–62, 145–8
 - support for users 60
- contractor–customer principle 74
- corporate structure 95, 155
- countercurrent chromatography *see* chromatography, liquid-liquid

- Crick Institute xix, 5, 46
 plans for a museum 63, 101
- cricket 76, 79–80
- culture
 Health and Safety xviii, 28, 29, 37, 43
 hierarchical 6, 10–11, 15–18, 79
 scientific xix, 51–2, 68–75, 151–2, 158
 scientists vs engineers and technicians 70, 88–9, 94–7, 158
 social life 75–80, 82–6, 119
- Dapsone 101
- dark rooms 38
- day release courses 17, 157
- DEC computers 48, 146, 147
- defence research 7, 9
- Developmental Biology Division 11, 38, 62
- dining rooms 6, 10–11, 15–16, 38, 69, 76
- Directors of the NIMR 47
see also individual Directors in Names index
- DNA, structure 8
- Dollis Hill (PO Research Establishment) 118
- dress codes 10, 20
 lab coats 15
- education and training 17, 110, 152, 157–8
- efficiency drives 99–100
- eggs, surplus 119
- electricity 38, 39, 136
 high-voltage power packs 50
- electron capture detectors (ECDs) 151, 154, 164–8, 167, 169
- electronics
 analog to digital system 90–1
 apnoea alarm 92
- Electronics Section (Ronan Cottage) 33, 48–9, 60, 89–90
 in the insulin infusion pump 56, 57, 57, 87, 88
 use of second-hand components 103–4, 118, 160
see also computers
- electrophoresis
 equipment 49–50, 49
 handling the gels 107–8
- EMI Systems 57
- Engineering Department 20, 46, 65, 98, 158
 cross-departmental charging 99–100
 general purpose workshop 106, 108–9, 159
 and increased technological complexity 90, 94, 96
 size 82, 88–90
 status 89, 94–7
 stopped doing research 70–1, 73–4, 93, 95
- environmental science 151, 169, 170
- epoxy resin varnish 30
- European Space Agency 44
- Everest expedition (1953) 12
- Farnell (A C Farnell Limited) 103, 105, 160
- fatty acid analysis 160–1, 166, 169
- fertility treatments 69–70
- finance *see* funding
- fire doors 112, 113
- fire safety 113–14
- fires, accidental 30, 39
- flame ionization detectors (FIDs) 164, 167
- Fletcher Memorial Hall 83, 113
- flooding 38
- flooring 27, 28, 37
- foreign scientists 46, 79, 99

- fraction collectors 21–3, 23, 127
- Francis Crick Institute *see* Crick Institute
- fume cupboards 131, 133, 137
 - cooking sausages in 119
- funding 51, 72, 74, 82, 99
 - for the insulin pump 52–3
 - money from patents 56, 98, 99
- galvanometer balances 52, 53
- gas chromatography (GC) 151, 156, 158, 160–70
 - measuring peak size 64–5, 149
- gas density meters 162–3
- gas supplies 39, 133
- geese 119–20
- gel electrophoresis *see* electrophoresis
- Genetics Division 11, 38
- glassware
 - cleaning 25, 114–15
 - making 26, 96, 110
- glucose monitoring systems 60, 88
- government reviews 71, 99–100
- grading 32, 107, 111, 154
- Graphics Department 123
- growth hormone releasing hormone (GHRH) 88
- guinea pigs 107
- Hampstead site 5–8, 9–10, 12–13, 34, 42, 151, 159
 - escaped monkeys 23–4
 - floor plans 10, 125–6
 - photograph 6
- Harwell (AERE)
 - cricket match against 80
 - supplies from 160
- Head Technicians Committee (House Committee) 31–2, 34, 110
- Health and Safety
 - attitude towards xviii, 28, 29, 37, 43
 - in early chemistry labs 131–3, 133–4
 - fire safety 113–14
 - food cooked in the labs 119
 - handbook 29
 - infectious diseases 33, 115
 - lapses *see* accidents
 - legislation 29, 37
 - and recycling 105
 - and the unions 116, 117
- helium 168
- hierarchical culture 6, 10–11, 15–18, 79
- Holly Hill *see* Hampstead site
- hot air balloons 76
- hours of work *see* working hours
- House Committee (Head Technicians Committee) 31–2, 34, 110
- Hughes Press 97, 98, 171
- Human Physiology Division 7, 9, 96–7
- human resources issues 73–4
 - pay and grading 32, 107, 111, 117, 154
 - see also* recruitment
- hyaluronidase 24–5
- hydrocarbon analysis 162–3, 167
 - halogenated 169, 170
- hydrogen sulphide 133
- hypnotism 13–14
- IBM computers 58–9, 59, 60, 61–2
- Immunology Division 32, 66–7, 68
 - see also* vaccines
- Imperial Cancer Research Fund 16
- industrial research laboratories 135–6, 135, 136–7
- infertility treatments 69–70
- infusion pumps 55
 - for GHRH 88
 - for insulin *see* insulin infusion pumps
 - for LHRH 69–70, 173–4

- Institute of Bioengineering 9
- Instrument Laboratory (Hampstead)
159
- instrumentation developed/made at
the NIMR 23, 34, 46, 47–50,
96, 108–9
see also apnoea alarms;
chromatography; infusion pumps;
ionization detectors
- insulin infusion pumps 51, 52–7, 70,
173
drivers 53–4, 53
electronics 56, 57, 57, 87, 88
income from 56, 98
liability 87, 93
measuring the flow 52, 53, 54–5
Novo Nordisk device 56, 56, 98
syringe siliconization 86–7
- insurance 87
- integrating motor pneumotachographs
9
- international profile 102
Biological Standards 21, 42
WHO collaborations 42, 101, 102
- internet, early versions 58, 145
- ionization detectors
argon 153, 165, 166, 168, 170
ECDs 151, 154, 164–8, 167, 169
FIDs 164, 167
- ISO 9000 standards 87
- IT (information technology) 47–8,
57–62, 145–8
support 60
- job descriptions 73
see also role of technicians
- jumble sales 105
- katharometers 161, 169
- Keeyok (boat) 82, 82, 83
- King's College London 8
- laboratory coats 15
- laboratory design 37–9
benches 15, 25, 30, 37, 39, 136
flooring 27, 28, 37
utilities 38, 39, 131, 133, 136
see also chemistry laboratories,
history
- laboratory equipment
army surplus/recycled 102–6, 118,
159–60
glassware 25, 110, 114–15
- late books 18–19
- legal liability 87, 92, 93, 94
- legislation
animal experimentation 26
Health and Safety 29, 37
- leprosy 75, 101–2
- Letraset 123
- library 38
- lifts
most efficient use of 113
privileged use of 17–18
unreliability of 6, 18, 111–12,
112–13
- liquid-liquid (countercurrent)
chromatography *see*
chromatography, liquid-liquid
- Lisle Street (London) 103, 104
- Lister Institute 156
- luteinizing hormone releasing hormone
(LHRH) infusion pumps 69–70,
173–4
- Maintenance Department 30–1, 75,
95
- malaria 33
- Manpower Services Group 100
- mass spectrometers 136, 163
- Medical and Biological
Instrumentation (MBI) 22–3, 50
- Medical Research Council (MRC) 7,
8, 51, 151

- budgets 71–2, 74, 99
- Cambridge unit relocated to Mill Hill 36–7, 67, 78
- ‘complementing’ 73
- tight-fistedness of 28, 32
- medical room 28, 115–16
- Mellanby Building 66, 75, 114
- Mexico Olympic Games (1968) *see* Olympic Games
- Microbiology Division (earlier Bacterial Chemistry) 24–5, 38, 75, 84, 97, 97, 111
- microprocessors 60, 145
- Mill Hill Infuser *see* insulin infusion pumps
- Mill Hill site
 - layout 10–11, 16, 38–9, 113, 159
 - move to 5, 8
 - official opening 77, 151
 - pen and ink drawing 14
- molecular biology 73, 90
- monoclonal antibodies 51
- morphine infusers 55
- Mount Vernon Hospital *see* Hampstead site
- mountaineering
 - research 12, 14
 - social trips 84
- mouth pipetting 28, 115
- MRC *see* Medical Research Council
- Mylar 76
- NASA (National Aeronautics and Space Administration) 40
- National Institute for Biological Standards and Control (NIBSC) 21, 42, 106–7
- National Institute for Medical Research: The place, the people, the science* (film) xvii
- National Research Development Corporation (NRDC) 98–9
- National Service 9, 21, 154
- National Westminster Bank 32
- Neurophysiology Division 68–9, 78, 95
- night work 43
- NIMROD (social club) 75–80, 82–6
 - NIMROD Magazine* (and alternatives) 85–6, 85
- Nobel prize-winners 4, 21, 41, 52, 102, 181
- Nordisk Infuser 55, 56, 56, 98
 - see also* insulin infusion pumps
- Northwick Park (Clinical Research Centre) 6, 72
- nuclear magnetic resonance (NMR) 46, 136
- oil industry 161–2, 164
- Olympic Games (1968) 12, 13
- open days/evenings 17, 120–4, 121, 122
- open-air laboratories 133–4
- optical transistors 103–4
- ordering systems 34, 100–1, 104–5
- organelle research 44, 70
- Oxford University chemistry laboratories 137
- pantomimes 78–9
- Parasitology Division (formerly Chemotherapy) 12, 19, 33, 75, 107–8
- Pasteur pipettes 26, 111
- patents 44, 56, 98–9, 163, 168
- patient monitoring devices 13
- pay 32, 117
- PDP-11 computers 48
- penicillin standards 21
- peristaltic pumps 63, 63
- personnel issues *see* human resources issues
- pesticide analysis 170

- pharmaceutical industry
 - drug purification 45
 - research laboratories 136–7
- Photographic Department 123
- Physics Exhibition 93
- physics laboratories 131
- pigs 66–7
- pipettes
 - manufacture 26, 111
 - mode of use 28, 43, 115
- planimeters 64, 93, 149
- plumbing, shortcomings 38, 39
- Pneumoconiosis Research Unit 8
- pneumotachographs 9
- porters 111–12
- practical jokes 19, 20, 33–4, 69, 84
- printers 61–2
- procurement
 - ordering systems 34, 100–1, 104–5
 - second hand/recycled material 102–6, 118, 159–60
- Proops (army surplus retailer) 103, 104
- proportional radioactivity counters 169
- public relations 122–3
 - see also* open days/evenings
- publications, technicians as co-authors 70, 158
- punch cards 57, 58
- rabbits 25
- ‘radio pill’ 13
- radioactivity
 - cobalt-60 source 115
 - GC detectors 164, 166
 - and Harwell 160
 - tritium counters 62
 - work with 25–6, 30
- Radiochemical Centre (Amersham) 25, 26
- Radiospares Limited 103, 160
- Ramsauer effect 168
- Rayner Review (1979) 99–100
- recruitment
 - MOD students 80, 81–2
 - scientific staff 8, 40–1, 46
 - Technical Officers 154
 - technicians 107
- recycling
 - army surplus 102–4, 118, 159–60
 - informal 26–7, 105–6
- research environment xix, 51–2, 68–75, 151–2, 158
- Research Officers (ROs) 32
- Rhesus monkeys 23–4
- Rhodes Farm 26, 120
- ‘The Role of the Medical Research Council’ (1974) 71
- role of technicians 4, 107–11, 152
- Ronan Cottage (Electronics section) 80, 89–90, 104
- Ronan Foundation 24
- Rothschild Report (1971) 74
- RS232 box 58
- safety *see* accidents; Health and Safety
- sailing club 82, 82, 83
- salaries 32, 117
- SAMI (socially acceptable monitoring) 13
- Saturday working 19, 20, 25, 26, 31
- Science Museum 16, 63
- scrap metal 26–7, 105
- sheep 26
- shooting club 83
- signing-in books 18–19, 43
- Silent Spring* (Carson) 151, 169
- siliconization process (for syringes) 86–7
- social life 75–80, 82–6, 119
- software 59–60
 - written in-house 48, 60, 91
- Sorvall (Thermo Scientific Fisher) 117

- space engineering 40, 44
- spectrometers 136, 163
- sperm sorting 68
- spin-off companies 22–3, 50
 - see also* commercialization of technology
- sports medicine 12, 13
- spreadsheets 59
- staff outings 77, 80, 84
- staining techniques 102
- Stanford University Stauffer
 - laboratories 136
- starch gels 107–8
- steam, used in the lab 133, 134
- steam trains 46
- stores 100–1, 109, 111
- strikes, lack of 116–17

- tea rooms 11, 75
- tea-making machine 122, 122
- teak benches 15, 25, 30, 37
 - recycled 105–6
- Technical Officers (TOs) 17, 111, 154, 168
- technology transfer *see*
 - commercialization of technology
- telephones 9
- tenure 74
- 3D view technology 62
- timekeeping 18–19
- toilet paper 34–5, 35
- trades unions 116–18
- training and education 17, 106–7, 152, 157–8
- transistors 103–4
- translational research 71, 72
 - see also* commercialization of technology

- tritium counters 62
- tropical diseases 19, 33, 75, 101–2
- trypanosomiasis 19, 33
- TSR2 aircraft 106
- tuberculosis 101
- turkeys 120
- tympanometers 98–9

- unions 116–18
- Uno Stencils 123
- USA, chemistry lab design 135, 136
- uterine blood flow monitors 93, 94
- utilities 38, 39, 131, 133, 136

- vaccines 23, 25, 102
- ventilation 42, 133–4
 - fume cupboards 131, 133, 137
- Virology Division 106

- washing of glassware 25, 114–15
- water supplies 38, 133
- wax
 - on benches 25, 30
 - on floors 27, 28
- Wellcome Research Laboratory 135
- women workers 6, 10, 16, 20
- word processing 59–60
- working hours 18–19
 - night-time 43
 - weekend working 9, 19, 20, 25, 26, 31
- Works and Maintenance Department 30–1, 75, 95
- World Health Organization (WHO) 42, 101, 102

- Zurich Federal Polytechnic chemistry labs 130, 131

Index: Names

Pages numbers in *italics* refer to photographs,
those in **bold** refer to biographical notes.

- Adlard, Edward 162
 Andrew, Colin 40
 Andrewes, Sir Christopher 116
 Anson, Mike 74, 91
- Balfour, Brigid 66
 Bayley, Peter 38
 Birch, S F 161
 Black, Stephen 13–14
 Boer, Hendrick 162, 164, 165
 Bower, Ralph 109, 163
 Brennan, Marilyn 122
 Brodarty, Miss 120
 Brook, Charles 88
 Brown, Sir George Lindor 9
 Brown, (Kendrick) Neil 12, 19, 33,
 106, 108
 Brunskill, General 15
 Bull, Sir Graham 72
 Bunn, Chris 60
 Bunsen, Robert 133
 Burgen, Sir Arnold 36, 37, 38, 46–7,
 69, 78, 112, 121, **177**
 Busby, Dennis 106
- Carmeci, Peter 70
 Chambers, Geof 54–6, *54*, 58–9, 60,
 69, 70, 85, 88, 98, **177**
 Chantril, Mr 118
 Childs, D G 163
 Clark, Nick 118
 Conant, Bob 109
 Cox, Mr 39
 Coyle, Ruth 27
 Craig, Lyman 43
 Cree, Mr 30
- Dale, Sir Henry 4, 9, 24, **177–8**
 de Rossi, Peter 42, 83–4
 de Rossi, Rosemary 6, 7, 8, 10, 17,
 18, 20, 21, 25–6, 28, 31–2, 62,
 82, 83, 84, 95, 99, 100, 106–7,
 107, 109, 111, 112, 114, 116–17,
 119, **178**
 Dean, Margaret 20
 Dean, Pamela 20
 Delderfield, Alan 70, 109
 Desty, Denis 161
 Doré, Frank 53, 55
 Draper, Philip 66
 Dresser, David 68
 Dymond, Jeff 70
- Edholm, Otto 7, 9
 Errington, Mick 78
- Feeney, Jim 38, 78–9
 Ferenczi, Mike 91
 Frobisher, Buffy (Rod King and Peter
 Turner) 85–6
- Gammage, Ken 26
 Gaze, Michael 38, 114
 Golay, Marcel 163
 Green, John 48
 Gregory, Norman 82, 154, 168
 Griffiths, Frances 73
- Harington, Sir Charles 6–7, 9, 17,
 19–20, 31, 68, 151, 156, **178**
 Hart, Philip d'Arcy 75
 Hawes, David 45
 Hawking, Frank 12, 26, 33
 Hawking, Stephen 80

- Hemmings, Arthur 116
 Heywood-Waddington, Deborah 44,
 70
 Higgins, Russell 80, 81, *81*, 90–1,
179
 Hills, Les 33–4, 33
 Himsworth, Richard 74
 Himsworth, Sir Harold 74
 Hobbs, Keith 108
 Hofmann, August Wilhelm 135
 Holliday, Robin 38, 114
 Holman, Trevor 61, 62, 105, 109
 Honess, Robert 84
 Hooper, Roger 66–7, 66, 76, 115,
179
 Humphrey, John 21, 32, 107
 Hunt, Colonel John 12
 Huxley, Sir Andrew 7
- Ida (driver) 119
 Ito, Y 41, 43
- Jacobs, Howard 69
 James, Anthony 41, 96, 153, 156,
 157, 160–4, *162*, 169
 Jarrett, Terry 32, 86
 Johnson, H W 149
 Jones, Sister 28, 115–16
- Kantorowicz, Dr 159
 Keene, Harry 52
 Keulemans, A I M 162
 Khan, Taslima xvii
 King, Eleanor 60
 King, Eric 20
 King, Martin 91
 King, Rodney 26–7, 86, 119–20, 122
 Kirkby, Dame Emma 84
- Lack, Charles 25
 Lang, Mrs 34
- Lavoisier, Antoine 131
 Lee, John 84
 Lewin, John 12, 13, 22, 33, 64, 70,
 90, 92, 149
 Lewis, William 129
 Liebig, Justus 131
 Lightbown, James 42
 Lister, W C (Bill) 96, 118
 Lovell-Badge, Robin xviii
 Lovelock, James 52, 68, 153, 154,
 158, 165–7, *165*, 169
- MacDonald, Mike 23
 MacDonald, Ramsay 24
 Macfarlane, (Robert) Gwyn 8
 Margery (tea lady) 15
 Marsh, Jonathan 11, *11*, 12, 13,
 15–16, 17, 18, *18*, 19, 20, 22–3,
 24, 26–7, 28, 31, 32, 33–4, 37,
 46, 48–9, 50, 54, 57, 59–60, 62,
 63, 64, 65, 68, 70–1, 76–7, 81,
 82, 83, 84, 85–6, 87, 89–90,
 91–2, 93, 94, 95, 96, 98, 99–100,
 101, 102–4, 104–5, 106, 107–9,
 112–13, 116, 117–18, 119, 120,
 122–3, *122*, 127, 158, **179–80**
 Martin, Archer 41, 43, 96, 153, 155,
 156, 160–3, *162*
 Mathison, Ian xviii, 10–11, *10*, 11,
 12, 15, 18–19, 21, 22, 24–5,
 27–8, 28–30, 31, 34–5, 38–9,
 49–50, 62–3, 71, 73, 75, 79–80,
 84–5, 85–6, 94, 97, 97, 100–1,
 105, 106, 110, 110–11, 111–12,
 113–14, 115–16, 117, 120–1,
 123–4, 171, **180**
 Medawar, Sir Peter 3, 11, 15, 31, 78,
 79–80, 96, **180–1**
 Mitchison, Avrion 116
 Moore, Robert 3
 Moran, Margaret 77

- Morgan, Hilary 16, 16, 20, 21–2, 25, 48, 63, 66, 75, 101–2, 104, 110, 114–15, 119, 123, **181**
- Morris, Peter 3, 16, 17, 36, 36, 129–38, 156, **181–2**
- Newland, Penny 42, 70
- Newman, Ivy 32
- Norman, Frank 4
- Nurse, Sir Paul 46, 71
- Otvos, John 164
- Parkes, Sir Alan 25
- Parsons, John 52, 55
- Payne, C C F 158
- Pearson, Annette 27
- Pearson, George 93
- Perkins, Harold 30
- Perkins, Jack 49, 93
- Perrin, Bill 23
- Perutz, Max 52
- Pickup, John 52
- Pinder, Andrew 46–8, 47, 58, 61, 65, 68–9, 72, 87, 95–6, 98–9, **182**
- Piper, Edwin Anthony (Pip) 13, 62, 103, 118, 152, 154, 158, 159–60, 166, 169
- Pollock, Martin 82
- Popják, George 160
- Porta, Livio Dante 46
- Porter, George (Lord Porter of Luddenham) 102
- Porter, Rodney 21
- Pratt, Ron 66
- Price, Bernard 18
- Prosser, Jack 30, 31
- Pugh, Griffith 12, 13, 20
- Ray, Neil 161
- Rees, Sir Dai 27
- Rogers, Howard 15, 24, 39, 97
- Ronan, Stephen 24
- Rothwell, Denis 40, 46, 71, 74, 84, 88
- Russell, Clive 118
- Ryan, Larry 34
- Satchell, John 122
- Sawkins, John 61–2, 61, 89, 89, 94, 95, 96, 105–6, 115, **182**
- Schunmann, Norman 110
- Sharman, Helen 44
- Sharp, John 41, 43, 46
- Short, Douglas 24, 106
- Short, Ronan 24
- Skehel, Sir John 118, 123, **182–3**
- Slim, Field Marshall 9
- Smith, Jim xvii–xix, *xix*, **183**
- Spensley, Dr 25
- Squire, John 72
- Stean, John 110
- Stevenson, David 164
- Stirling, Vicky 100
- Sutherland, Ian 40–5, 40, 49, 51, 52–4, 55, 56–7, 59, 66, 69–70, 73–4, 75–6, 83, 86–7, 88, 94, **183–4**
- Syngé, Richard 155, 156
- Tansey, Tilli 3–5, 3, 9, 10, 14–15, 20, 21, 28, 30, 31, 34, 35, 36, 37, 50, 51, 52, 67, 69, 73, 75, 79, 90, 91, 92, 93, 94, 96, 98, 102, 116, 124, **184**
- Thatcher, Baroness Margaret 99
- Topham, Mrs 25
- Townend, Pauline 61
- Travis, Anthony 3, 23, 43, 44, 64–5, 64, 67, 102, 104, 149, 151–70, **185**
- Tuckey, Harriet 12, 14
- Turner, Peter 36–7, 37, 38, 50–1, 77–9, 86, 107, 112–13, 120, 121, 123, **185–6**

- Ward, Leonard 10
Wheeler-Robertson, Bernard 159
White, Steven 54, 55, 57–8, 58, 60,
69, 70, 84, 87, 88–9, 93, 123,
145–8, **186**
Wills, John 118
Winterton, Nick 73
Wolff, Heinz 5–6, 5, 6–7, 8–9, 12,
13–14, 19, 20, 21, 23–4, 34, 35,
44, 51, 71–2, 74, **186**
Woodcock, John 79
Woodget, Laurence 154–5, 166
Work, Thomas 27
Wright, Martin 48, 51, 52, 55

VOLUMES IN THIS SERIES*

1. **Technology transfer in Britain: The case of monoclonal antibodies
Self and non-self: A history of autoimmunity
Endogenous opiates
The Committee on Safety of Drugs (1997)** ISBN 1 86983 579 4
2. **Making the human body transparent: The impact of NMR and MRI
Research in general practice
Drugs in psychiatric practice
The MRC Common Cold Unit (1998)** ISBN 1 86983 539 5
3. **Early heart transplant surgery in the UK (1999)** ISBN 1 84129 007 6
4. **Haemophilia: Recent history of clinical management (1999)**
ISBN 1 84129 008 4
5. **Looking at the unborn: Historical aspects of
obstetric ultrasound (2000)** ISBN 1 84129 011 4
6. **Post penicillin antibiotics: From acceptance to resistance? (2000)**
ISBN 1 84129 012 2
7. **Clinical research in Britain, 1950–1980 (2000)**
ISBN 1 84129 016 5
8. **Intestinal absorption (2000)**
ISBN 1 84129 017 3
9. **Neonatal intensive care (2001)**
ISBN 0 85484 076 1
10. **British contributions to medical research and education in Africa
after the Second World War (2001)** ISBN 0 85484 077 X

* All volumes are freely available online at: www.histmodbiomed.org/article/wellcome-witnesses-volumes .They can also be purchased from www.amazon.co.uk; www.amazon.com, and from all good booksellers.

11. **Childhood asthma and beyond (2001)**
ISBN 0 85484 078 8
12. **Maternal care (2001)**
ISBN 0 85484 079 6
13. **Population-based research in south Wales: The MRC Pneumoconiosis Research Unit and the MRC Epidemiology Unit (2002)**
ISBN 0 85484 081 8
14. **Peptic ulcer: Rise and fall (2002)**
ISBN 0 85484 084 2
15. **Leukaemia (2003)**
ISBN 0 85484 087 7
16. **The MRC Applied Psychology Unit (2003)**
ISBN 0 85484 088 5
17. **Genetic testing (2003)**
ISBN 0 85484 094 X
18. **Foot and mouth disease: The 1967 outbreak and its aftermath (2003)**
ISBN 0 85484 096 6
19. **Environmental toxicology: The legacy of *Silent Spring* (2004)**
ISBN 0 85484 091 5
20. **Cystic fibrosis (2004)**
ISBN 0 85484 086 9
21. **Innovation in pain management (2004)**
ISBN 978 0 85484 097 7
22. **The Rhesus factor and disease prevention (2004)**
ISBN 978 0 85484 099 1
23. **The recent history of platelets in thrombosis and other disorders (2005)** ISBN 978 0 85484 103 5

24. **Short-course chemotherapy for tuberculosis (2005)**
ISBN 978 0 85484 104 2
25. **Prenatal corticosteroids for reducing morbidity and mortality after preterm birth (2005)** ISBN 978 0 85484 102 8
26. **Public health in the 1980s and 1990s: Decline and rise? (2006)**
ISBN 978 0 85484 106 6
27. **Cholesterol, atherosclerosis and coronary disease in the UK, 1950–2000 (2006)** ISBN 978 0 85484 107 3
28. **Development of physics applied to medicine in the UK, 1945–1990 (2006)** ISBN 978 0 85484 108 0
29. **Early development of total hip replacement (2007)**
ISBN 978 0 85484 111 0
30. **The discovery, use and impact of platinum salts as chemotherapy agents for cancer (2007)** ISBN 978 0 85484 112 7
31. **Medical ethics education in Britain, 1963–1993 (2007)**
ISBN 978 0 85484 113 4
32. **Superbugs and superdrugs: A history of MRSA (2008)**
ISBN 978 0 85484 114 1
33. **Clinical pharmacology in the UK, c. 1950–2000: Influences and institutions (2008)** ISBN 978 0 85484 117 2
34. **Clinical pharmacology in the UK, c. 1950–2000: Industry and regulation (2008)** ISBN 978 0 85484 118 9
35. **The resurgence of breastfeeding, 1975–2000 (2009)**
ISBN 978 0 85484 119 6
36. **The development of sports medicine in twentieth-century Britain (2009)** ISBN 978 0 85484 121 9

37. **History of dialysis, c.1950–1980 (2009)** ISBN 978 0 85484 122 6
38. **History of cervical cancer and the role of the human papillomavirus, 1960–2000 (2009)** ISBN 978 0 85484 123 3
39. **Clinical genetics in Britain: Origins and development (2010)**
ISBN 978 0 85484 127 1
40. **The medicalization of cannabis (2010)**
ISBN 978 0 85484 129 5
41. **History of the National Survey of Sexual Attitudes and Lifestyles (2011)** ISBN 978 0 90223 874 9
42. **History of British intensive care, c.1950–c.2000 (2011)**
ISBN 978 0 90223 875 6
43. **WHO Framework Convention on Tobacco Control (2012)**
ISBN 978 0 90223 877 0
44. **History of the Avon Longitudinal Study of Parents and Children (ALSPAC), c.1980–2000 (2012)**
ISBN 978 0 90223 878 7
45. **Palliative medicine in the UK c.1970–2010 (2013)**
ISBN 978 0 90223 882 4
46. **Clinical cancer genetics: Polyposis and familial colorectal cancer c.1975–c.2010 (2013)** ISBN 978 0 90223 885 5
47. **Drugs affecting 5-HT systems (2013)**
ISBN 978 0 90223 887 9
48. **Clinical molecular genetics in the UK c.1975–c.2000 (2014)**
ISBN 978 0 90223 888 6
49. **Migraine: Diagnosis, treatment and understanding c.1960–2010 (2014)**
ISBN 978 0 90223 894 7

50. **Monoclonal antibodies to migraine: Witnesses to modern biomedicine, an A–Z (2014)** ISBN 978 0 90223 895 4
51. **The recent history of seasonal affective disorder (SAD) (2014)**
ISBN 978 0 90223 897 8
52. **The development of narrative practices in medicine c.1960–c.2000 (2015)** ISBN 978 0 90223 898 5
53. **The development of brain banks in the UK c.1970–c.2010 (2015)**
ISBN 978 1 91019 5024
54. **Human Gene Mapping Workshops c.1973–c.1991 (2015)**
ISBN 978 1 91019 5031
55. **A history of bovine TB c.1965–c.2000 (2015)**
ISBN 978 1 91019 5055
56. **The development of waste management in the UK c.1960–c.2000 (2015)** ISBN 978 1 91019 5062
57. **Medical genetics: Development of ethical dimensions in clinical practice and research (2016)** ISBN 978 1 91019 5130
58. **Air pollution research in Britain c.1955–c.2000 (2016)**
ISBN 978 1 91019 5147
59. **Technology, techniques, and technicians at the National Institute for Medical Research (NIMR) c.1960–c.2000 (2016)**
ISBN 978 1 91019 5161 (this volume)

UNPUBLISHED WITNESS SEMINARS

- 1994 **The early history of renal transplantation**
- 1994 **Pneumoconiosis of coal workers**
(partially published in volume 13, *Population-based research in south Wales*)
- 1995 **Oral contraceptives**
- 2003 **Beyond the asylum: Anti-psychiatry and care in the community**
- 2003 **Thrombolysis**
(partially published in volume 27, *Cholesterol, atherosclerosis and coronary disease in the UK, 1950–2000*)
- 2007 **DNA fingerprinting**

The transcripts and records of all Witness Seminars are held in archives and manuscripts, Wellcome Library, London, at GC/253.

OTHER PUBLICATIONS

Technology transfer in Britain: The case of monoclonal antibodies

Tansey E M, Catterall P P. (1993) *Contemporary Record* **9**: 409–44.

Monoclonal antibodies: A witness seminar on contemporary medical history

Tansey E M, Catterall P P. (1994) *Medical History* **38**: 322–7.

Chronic pulmonary disease in South Wales coalmines: An eye-witness account of the MRC surveys (1937–42)

P D'Arcy Hart, edited and annotated by E M Tansey. (1998)
Social History of Medicine **11**: 459–68.

Ashes to Ashes – The history of smoking and health

Lock S P, Reynolds L A, Tansey E M. (eds) (1998) Amsterdam: Rodopi BV, 228pp. ISBN 90420 0396 0 (Hfl 125) (hardback). Reprinted 2003.

Witnessing medical history. An interview with Dr Rosemary Biggs

Professor Christine Lee and Dr Charles Rizza (interviewers). (1998)
Haemophilia **4**: 769–77.

Witnessing the Witnesses: Pitfalls and potentials of the Witness Seminar in twentieth century medicine

Tansey E M, in Doel R, Søderqvist T. (eds) (2006) *Writing Recent Science: The historiography of contemporary science, technology and medicine*. London: Routledge: 260–78.

The Witness Seminar technique in modern medical history

Tansey E M, in Cook H J, Bhattacharya S, Hardy A. (eds) (2008) *History of the Social Determinants of Health: Global Histories, Contemporary Debates*. London: Orient Longman: 279–95.

Today's medicine, tomorrow's medical history

Tansey E M, in Natvig J B, Swärd E T, Hem E. (eds) (2009) *Historier om helse (Histories about Health, in Norwegian)*. Oslo: *Journal of the Norwegian Medical Association*: 166–73.

Key to cover photographs

Front cover, left to right

Mrs Rosemary de Rossi

Professor Heinz Wolff

Mr Ian Mathison

Mr Jonathan Marsh

Back cover, left to right

Mrs Hilary Morgan

Mr John Sawkins

Dr Andrew Pinder

Professor Ian Sutherland