



# Application of structural topology optimisation to perforated steel beams



Konstantinos Daniel Tsavdaridis<sup>a,\*</sup>, James J. Kingman<sup>b</sup>, Vassilli V. Toropov<sup>c</sup>

<sup>a</sup> Institute for Resilient Infrastructure, School of Civil Engineering, University of Leeds, Woodhouse Lane, LS2 9JT Leeds, UK

<sup>b</sup> AKT II, 100 St John Str., EC1M 4EH London, UK

<sup>c</sup> School of Engineering and Materials Science, Queen Mary University of London, Mile End Road, E1 4NS London, UK

## ARTICLE INFO

### Article history:

Received 31 July 2014

Accepted 5 May 2015

Available online 19 June 2015

### Keywords:

Castellated

Cellular

Novel web opening

Structural topology optimisation

SIMP technique

Opening configuration

## ABSTRACT

This paper focuses on the application of structural topology optimisation technique to design steel perforated I-sections as a first attempt to replace the traditional cellular beams and better understand the mechanisms involved when subjected to bending and shear actions. An optimum web opening configuration is suggested based on the results of parametric studies. A FE analysis is further employed to determine the performance of the optimised beam in comparison to the conventional widely used cellular type beam. It is found that the optimised beam overperforms in terms of load carrying capacities, deformations, and stress intensities. Barriers to the implementation of the topology optimisation technique to the routine design of beam web are highlighted.

© 2015 The Authors. Published by Elsevier Ltd. This is an open access article under the CC BY license (<http://creativecommons.org/licenses/by/4.0/>).

## 1. Introduction

The judicious placement of holes in the webs of steel beams has been employed to design lighter and stiffer beams for over 100 years. The research focuses on steel I-section beams with perforations in the web which are variously known as; castellated beams (with hexagonal openings) and cellular beams (with circular openings) under the “umbrella” of perforated beams. The most important benefits when using such sections are the improved weight-to-stiffness ratio, the ability to integrate building services into the structural depth and the perceived aesthetic appeal of the beam [1]. The literature on the structural behaviour of steel I-section beams with standard circular, rectangular, and hexagonal web opening configurations is extensive [2–6]. The constant desire for improvement and mature level of understanding of the structural action of perforated steel sections has recently led to novel opening shapes being investigated [7–9]. The novel opening shapes are claimed to have beneficial fabrication, structural performance, usage in terms of service investigation and aesthetic qualities when compared to standard opening types.

The aesthetics of cellular beams have long been a crucial design consideration. The switch from castellated style beams to cellular beams in the early 1990s has been attributed to the perceived

aesthetic appeal of the circular opening [1,5]. More recently the “Angelina” style beam was first suggested by Claude Vasconi, an architect, with the consideration of aesthetic appeal at the fore [10,11].

The progression of the design of beams with web openings, from the original castellated design to the currently used cellular design and the newly developed sinusoidal design clearly shows that ultimate mechanical performance of the section is not always the aim of development. Aesthetic appeal may justify the development of a new section in the absence of any mechanical performance gains.

All of the opening shapes and configurations previously considered in the literature are constrained by the requirement that they can be manufactured by the profile cutting procedure. The profile cutting procedure, also known as castellation, is a method of manufacturing beams with web openings whereby a “parent” steel I-section is selected and a zig-zag pattern is (oxy or plasma) cut along the web of the section. The sections are then expanded and welded along the teeth of the zig-zag to form a deeper section with web openings (Fig. 1a). It is obvious that if a beam is to be formed using this process the possible geometry of the web openings is constrained. The profile cutting procedure is currently regarded as the most economical and standardised method of fabricating beams with web openings. The only exception being when wide elongated web openings are considered.

\* Corresponding author.

E-mail address: [k.tsavdaridis@leeds.ac.uk](mailto:k.tsavdaridis@leeds.ac.uk) (K.D. Tsavdaridis).

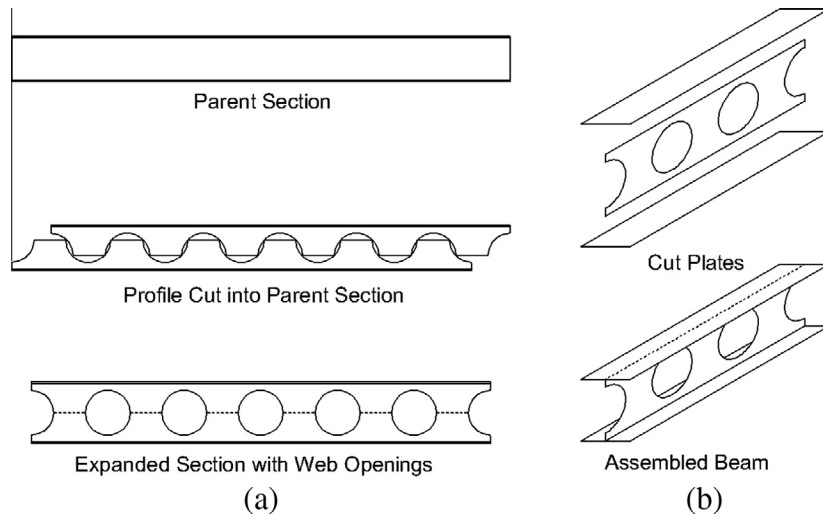

Fig. 1. (a) Castellation manufacturing process, (b) plate assembly manufacturing process.

More recently an alternative fabrication technique, plate assembly (Fig. 1b), has been adopted by several leading fabricators of cellular beams. The plate assembly technique offers significantly increased design freedom in terms of the shape and layout of web hence elongated web openings can be accommodated as well as non-periodically spaced web openings of various sizes and shapes. It is, however, considered an expensive solution due the long welding line along the plates (web and flanges) and the demanding requirements for accuracy when the perforations are engraved.

Nowadays the latter fabrication method is considered as more advantageous and adaptive to the needs of the architect and design engineer, hence it becomes more and more prevalent and efficient for steel construction.

To this point, no research found in the literature presenting any formal structural optimisation studies that have been performed with the aim of improving the design of steel I-section beam web opening shapes used in civil engineering and particularly building applications. Previous advancements in web opening configurations have rather relied upon engineering intuition and experience. Structural topology optimisation is a design tool which can be used to determine information on the optimum number, shape and size of openings within a user defined structural domain.

## 2. Aim of the study

The placement of openings within the web of steel I-section beams improves the mass-to-stiffness ratio of the section. An improved weight-to-stiffness ratio enables the realisation of longer spans without incurring a significant cost penalty in terms of material usage and deflections due to self-weight.

The main aim of the present research study is to investigate the potential for different web opening configurations in structural perforated beams using formalised structural optimisation techniques. Specifically, structural topology optimisation is to be applied to the design of the steel beam web as a first attempt to replace the conventional cellular beams, investigating the alternatives for perforated beams which fulfil certain boundary criteria as well as visualise the structural mechanisms involved when the beams are subjected to bending and shear forces.

The objectives of this study are (i) to apply a structural topology optimisation technique to the design of a steel I-section beam web; (ii) to investigate the structural behaviour of a simply supported beam subjected to vertical shear actions with a topology optimised web, using nonlinear finite element (FE) analysis; (iii) to invent an effective opening configuration for a wide variety of beam

cross-sections found in practice through an extensive parametric study; (iv) to establish a nonlinear FE analysis technique which can be used to determine the web buckling load of the topology optimised beam web concept; and (v) to parametrically investigate the local buckling behaviour of such thin-walled perforated webs while changing the geometric characteristics of the new web opening architecture and compare with existing web opening designs.

## 3. Optimisation

### 3.1. Previous works on optimisation of perforated beams

Within the literature very limited information exists regarding the optimisation of cellular beams. Erdal et al. [12] conducted an investigation into the optimum combination of parent section, number of openings and size of openings for a cellular beam. The problem, as described, is a discrete programming problem and both harmony search and particle swarm optimisation techniques were investigated. The response of the beam, bending capacity, shear capacity and deflection, were calculated using design equations given by BS5950 [13].

An alternative approach has been presented by Lagaros et al. [14]. The design of a steel framed structure, incorporating cellular beam elements, was considered. The cross-sectional dimensions of the sections were defined as size variables whilst the number and size of web openings were defined as shape and topology optimisation variables, respectively. A FE simulation of the frame was employed to determine the structural response. The authors found it necessary to use an evolutionary based optimisation algorithm due to the mixed, discrete-continuous design variables.

Later, Tsavdaridis and D'Mello [7] have presented a parametric optimisation study on an elliptically shaped web opening. The parametric study involved the FE analysis of models with various permutations of the elliptical opening geometric parameters  $\theta$  and  $R$ . Shear-moment interaction curves were produced for various combinations of the geometric parameters. It was reported that the elliptical opening configuration showed enhanced structural performance in comparison to circular and hexagonal web openings.

Kingman et al. [15] have presented the first part of this study in 2013 on structurally optimised perforated beams. The completion of parametric studies as well as the investigation and development of realistic web models with practical opening configurations is further conducted in the current study to acknowledge the potential for use of such optimised beams and the sensitivity of their geometric characteristics.

### 3.2. Structural optimisation

Structural optimisation can be divided into three distinct problem categories; topology, shape and size optimisation [16]. A degree of overlap exists between the three categories, and arguably a combination of two or more of the categories previously defined constitute a fourth category. The most succinct explanation of the three methods is pictorial (Fig. 2).

It can be seen that of the three methods topology optimisation is the most general, yielding information on the number and shape of openings within a generalised material continua. Potential overlap between the three categories is also apparent since it may be possible to derive a structural topology based on sizing optimisation, provided that the minimum size of a member is defined as zero.

Structural optimisation techniques are most commonly applied to the design of automotive and aerospace structures where weight savings are critical. The application of structural optimisation techniques to the design of building and civil/structural engineering structures is, however, a more challenging proposition. These challenges are discussed in this paper.

### 3.3. Structural engineering and optimisation

Design optimisation techniques are generally best applied to products intended for mass production where even small savings, per product, can lead to substantial savings over a large production run [17]. It is, however, generally the case that civil engineering construction projects are of a one off nature and the standardisation of components is limited. Civil engineering structures and components are generally designed based on precedent works and experience.

The civil engineering industry is inherently conservative when considering newly suggested products or techniques [18]. This conservative nature is a direct result of the large risks associated with civil engineering project in terms of both safety and finance. The general perception being that to deviate from precedent leads to unacceptable risks. If a new design is suggested the benefits, in terms of cost saving, must be such that it makes the perceived risk of adopting the new design acceptable.

A further technical challenge of applying design optimisation techniques, within the field of civil structural engineering, is the wide range of disparate and complex design requirements. An elegant design example, presented by Nolan [19], demonstrates that it is often the case that designs will be constrained by factors that are not easily quantifiable, such as manufacturability or aesthetic appeal. Within this context, focusing on an optimisation study, the design of a mass produced component such as perforated beams, may present an opportunity to find material and cost savings within building structures. Moreover, design regulations for such innovative structural elements should be established in the near future to support their use in practice.

## 4. Introductory study on a full length beam section

Initially, a topology optimisation study was performed on the web of a simply supported steel I-section beam of a 5 m span. A typical UB 305 × 165 × 40 was selected on the basis that it is a fairly common section to find in practice and mainly in building applications. Thereafter, the structural behaviour of the optimised beam was compared to a similar beam but with circular web openings, by carrying out a nonlinear FE analysis. The topology optimisation studies were performed using Altair Engineering's Optistruct software. The comparative nonlinear FE analysis studies were performed using ANSYS v.14.0.

### 4.1. Topology optimisation approach and SIMP technique

Structural topology optimisation is concerned with the identification of the optimum number and location of openings, within a defined designable structural continuum to fulfil a given objective, subject to applied loading and constraints. Numerous techniques for the solution of structural topology optimisation problems have been suggested [20–23]. The first solutions to a topology optimisation problem were produced by Michell [24]. Michell's solutions, for cases of simple loading and boundary conditions, provide optimal topologies for truss-like structures. The basic premise of the Michell's solutions is that it is most efficient for structural elements to follow the lines of principal stress within the ground continua. Further analytical solutions have been identified for simple topology optimisation problems [25–27]. However, the complexity of problems of interest to practicing engineers makes the use of analytical solutions impractical.

Rozvany [28] identified the work of Rosow and Taylor [29], on the design of variable thickness sheets, as the first attempt to derive an optimal topology using numerical techniques. The use of FE analysis, coupled with optimisation algorithms, has become the standard procedure for solving topology optimisation problems. Sigmund and Peterson [30] conceptualised the use of FE meshes in topology optimisation problems thus; "one may consider the design domain as a black and white television screen divided into a lot of small pixels (finite elements), and by turning material on and off in each pixel, one can produce a picture of the optimal structure" [30]. Rozvany [28] and Eschenhour and Olhoff [31] presented thorough reviews and critiques of contemporary topology optimisation techniques. Eschenhour and Olhoff [31] suggested that topology optimisation techniques can be defined into two broad categories; material- or micro- approaches and geometrical- or macro approaches.

Micro approaches, and specifically the Solid Isotropic Material with Penalisation (SIMP) technique, are the most widely utilised [28]. The SIMP technique, after Bendsoe [32], is a micro approach where the optimal structural topology is sought by varying the density of the material within the designable domain. A FE analysis of the structure is performed to determine the structural response of interest which may include; stress, displacement, compliance and buckling load, amongst others. Numerous developments and extensions of the SIMP method have been developed, accounting for a wide variety of structural behaviours.

Evolutionary Structural Optimisation (ESO), a macro approach, proposed by Xie and Steven [20] is currently the only potentially viable alternative to the SIMP method. The basic concept of ESO is to remove material, in the form of finite elements, from areas of the designable domain that are underutilised. This type of macro approach differs from the aforementioned material approaches in the respect that the FE mesh itself is altered during the optimisation process. Criticisms of the ESO method [28,33] focus on its heuristic nature. Improvements and extensions of ESO have been suggested, most notable Bi-directional Evolutionary Structural Optimisation [34], but the basic criticism remains unaddressed.

Newly developed structural topology optimisation techniques, including; the bubble method [21], level-set method [22] and topological derivative methods [23], can be described as macro approaches. Whilst many of these techniques are potentially improvements on currently available methods, none are currently at a stage of development that allows their commercial application [28].

It is generally desirable to develop the so called 0-1 design where the final distribution of material, within the design space, is comprised entirely of either solid material or voids. The solution of the 0-1 problem directly has been attempted, for instance the

ESO technique. It is however, generally the case that the application of such techniques is computationally prohibitive due to the number of finite elements necessary to model the design space. The SIMP technique addresses this problem by defining the material within each finite element as a continuous design variable. It is worth to mention that by converting the design variable from discrete to continuous, it is possible to use more computationally efficient mathematical programming methods for the solution of the original problem [35].

Intermediate density material, which neither takes the value of solid nor void, is generally not desirable since it is not possible to realise such intermediate densities within a real world structure. In order to avoid the presence of intermediate densities, within the final design, a penalisation is used to disproportionately decrease the benefit derived by the presence of intermediate density material. Penalisation of intermediate densities is achieved, within SIMP, by relating the stiffness of the material to the density thus:

$$E = \rho^P$$

In practical implementation it has been found that by specifying a large value of  $P$ , it may result in convergence to a local minima and a poor final design. A continuation method, whereby the value of the penalisation factor is gradually increased through the iterations, has been implemented but does not guarantee convergence to a global optimum 0-1 design [36].

Two basic approaches to topology optimisation using the SIMP technique exist:

- **Minimum Compliance Design:** The minimisation of a specific performance measure subject to a constraint on the available resources. Usually the compliance of the structure will be defined as the optimisation objective with a constraint on the available material.
- **Minimum Weight Design:** The minimisation of the mass of the structure with constraints on specific performance measures. The specific performance measures will usually be defined as stress, displacement, buckling load factor or any combination thereof.

Both of the approaches have been examined in the literature. The efficacy of the two approaches is debated with numerous advantages and disadvantages associated with each as shown below.

MINIMUM COMPLIANCE DESIGN	MINIMUM WEIGHT DESIGN
<ul style="list-style-type: none"> <li>▪ Most commonly used approach.</li> <li>▪ Well understood formulation with efficient solvers enabling rapid studies.</li> <li>▪ Most effectively applied at conceptual design stage (cannot be easily translated to viable structural designs).</li> <li>▪ Performance targets such as maximum stress cannot be specified in the optimisation process.</li> </ul>	<ul style="list-style-type: none"> <li>▪ Specific performance targets such as maximum stress or buckling load can be specified in the problem formulation.</li> <li>▪ The use of common structural responses such as stress, buckling load, and natural frequency as constraints can cause convergence issues and are limited to specialised solution techniques.</li> </ul>

The SIMP technique [34] is currently cited as being the most prevalent method of solving topology optimisation problems with the firmest mathematical basis [28,31].

#### 4.2. Study model of full length web beam

A FE model of the steel beam section was created to determine the structural response of the entire beam for use in the optimisation algorithm. The beam was modelled using shell elements with

a nominal size of 10 mm. A linear elastic material model was used with Young's Modulus and Poisson's Ratio of 200 GPa and 0.3, respectively. Uniform pressure loading was applied to the top flange of the beam. Constraints were applied to the end of the lower flange to model the support conditions. A standard linear static FE analysis approach was employed herein.

The maximisation of structural stiffness subject to a constraint on the available material has been shown to be effective when attempting to identify conceptual designs [37]. The optimisation approach taken was, therefore, the one of minimising compliance subject to a constraint on the available material.

It is worth to mention that the implementation of the SIMP technique, for the solution of practical problems, results in numerical complications [30]. The main numerical complications are the mesh dependency and the checkerboard problem. As a high number of finite elements used to discretise the design space, an increased number of openings within the design space will be present in the final design. Numerous techniques have been suggested for generating mesh independent solutions including; perimeter constraints, local density gradient constraints, filtering of densities, filtering of sensitivities and Monotonicity based minimum Length scale (MOLE) controls. Whilst all of the methods listed control the geometry of the final solution, the MOLE technique, after Poulsen [38], allows an explicit statement of the minimum desired member size. The added advantage of this technique being that manufacturability can be directly incorporated into the topology optimisation problem.

Consequently, in order to prevent the emergence of small scale features in the topology optimisation results, the so called minimum member size control was used in this study. A minimum member size of 30 mm was specified in order to prevent any design features at a scale smaller than this from emerging in the topology optimisation results.

As it was aforementioned, the SIMP technique was used to solve the topology optimisation problem. In order to identify a discrete solid-void final design using the SIMP technique, it is necessary to specify an appropriate value for the intermediate density material penalisation factor [35]. The most appropriate penalisation factor for this specific problem was investigated through sensitivity studies and it was found that a factor of 4 was satisfactory.

The topology optimisation study was performed initially considering variations in the maximum available material constraint. The material constraint is specified in terms of a volume fraction,

where the maximum material allowed in the final design is described as a fraction of the material present at the beginning of the optimisation. Volume fraction constraints of 0.5, 0.4 and 0.3 were studied. A penalisation factor of 3 was initially specified as it was recommended [39].

#### 4.3. Results

The results of the topology optimisation studies are presented in the form of element density plots in Fig. 3. Note that the element



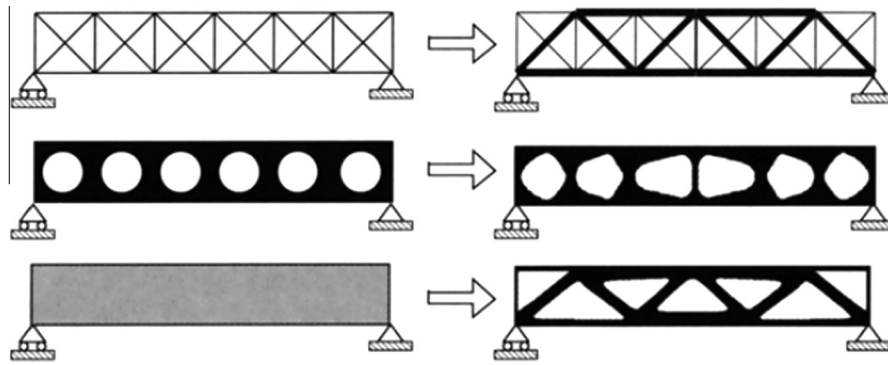

Fig. 2. The three categories of structural optimisation: (a) sizing optimisation of a truss structure, (b) shape optimisation, and (c) topology optimisation; the initial problems (left) and the optimal solutions (right).

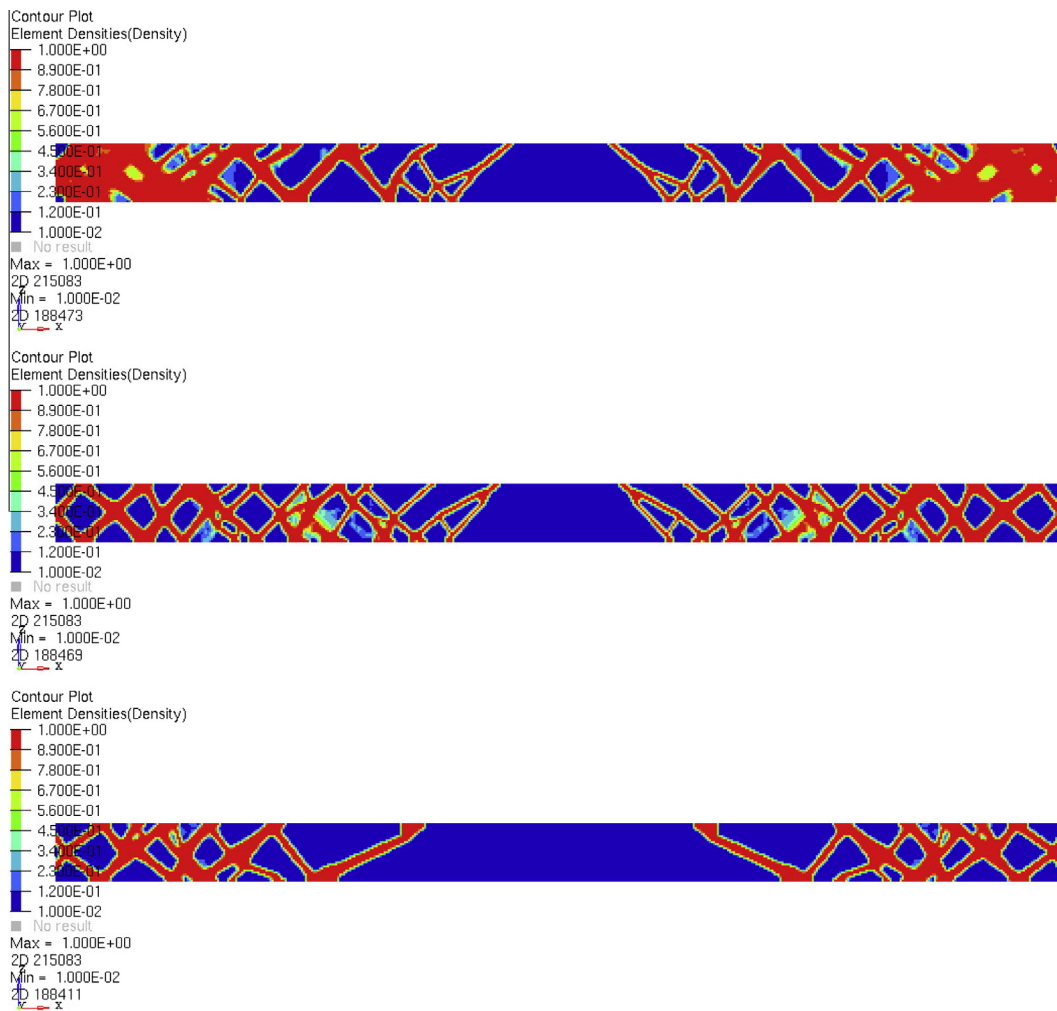

Fig. 3. Results of topology optimisation studies on 5 m span UB 305 × 165 × 40 with varying volume fraction constraints.

density plots represent the optimal material distribution upon convergence of the optimisation. The red<sup>1</sup> (light colour) zones represent the solid material, whilst the blue (dark colour) zones represent the suggested locations for openings. The transitional zones represent material of an intermediate density.

<sup>1</sup> For interpretation of colour in Fig. 3, 4, 5, 11, 12, and 13, the reader is referred to the web version of this article.

It is observed that a complex and irregular truss-like design was formed. It is also noted that more material appeared to be distributed to areas of high shear, towards the supports. Where bending forces are predominant in the flanges, towards the mid-span, the topology optimisation suggested the placement of no web material. It is also appeared that the beam web elements, as suggested by the topology optimisation, follow lines of the principle stresses in the beam web.

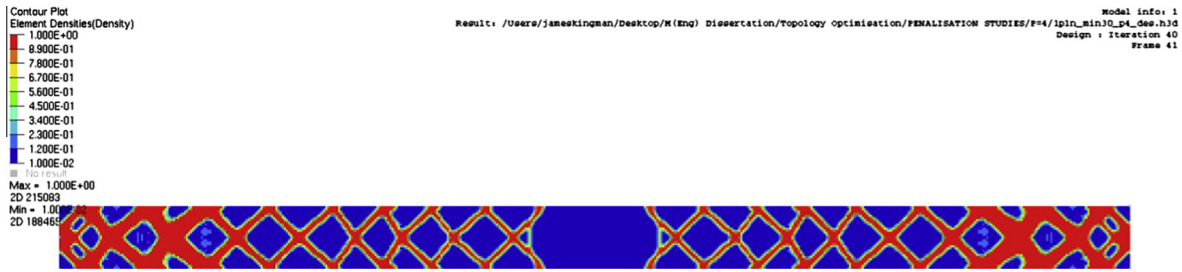

Fig. 4. Symmetry constrained topology optimisation study on 5 m span UB 305 × 165 × 40 with a constraint on the volume fraction of 0.4.

It is generally the case that structures designed using topology optimisation will have a more complex geometry than those developed from engineering intuition. This can limit the applicability of topology optimisation derived designs in practice as it may not be possible to manufacture them.

The issue of manufacturability has been addressed through the inclusion of manufacturing constraints in the topology optimisation problem. Suggested manufacturing constraints include: symmetry, casting constraints [32], extrusion constraints [40], and pattern graduation [41]. More recently a novel approach has been suggested for enforcing vertical beam like elements only in topology optimisation results [42].

Following, a symmetry constrained topology optimisation was performed. Lines of symmetry about the centreline and longitudinal axis of the beam were specified in both vertical and horizontal planes and a topology optimisation was performed using a volume fraction constraint of 0.4. The results of the symmetry constrained topology optimisation study (Fig. 4) showed a more rational truss-like design with rhomboidal web openings which periodically change along the length of the beam. Similarly, a large opening was suggested at the mid-span of the beam. It became visible that the material is distributed within the beam web

according to the ratio of shear and bending moment acting on the section.

It is evident that none of the designs suggested in the topology optimisation study could be manufacturable using the profile cutting procedure. The plate assembly technique, therefore, need to be implemented to realise the designs.

4.4. Comparison of cellular and topology optimised beams

4.4.1. Post-processing topology optimisation results

It was necessary to post-process the topology optimisation results in order to define the beam web geometry to be used in the comparative study. The first step in the post-processing procedure was completed using the OSSmooth feature of Altair Engineering’s Hypermesh FE pre- and post-processing software. An element density threshold was specified defining the element density above which the design was interpreted as solid geometric surfaces. Thereafter, Laplacian smoothing is performed by OSSmooth to smooth the boundaries of the design (Fig. 5). Following the initial geometry extraction using OSSmooth, a manual intervention was necessary in order to define the geometry of the beam web as a series of curves in AutoCAD.

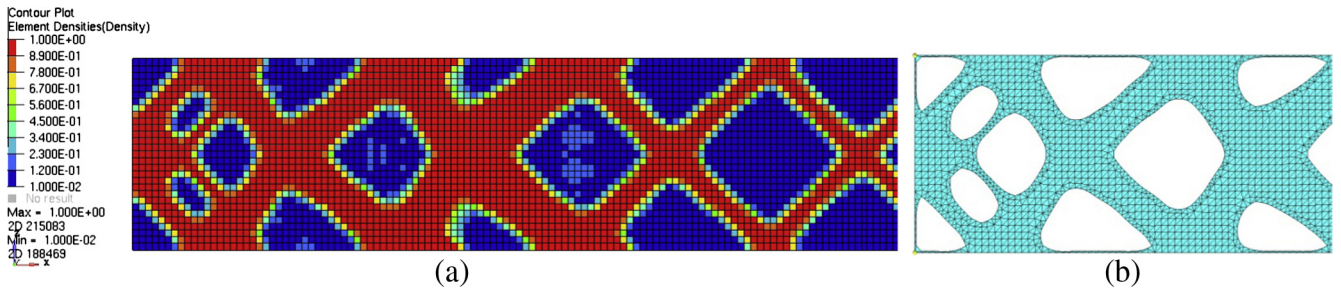

Fig. 5. Extracting geometry from element density results of topology optimisation using OSSmooth: (a) element density plot, (b) geometrically defined surfaces.

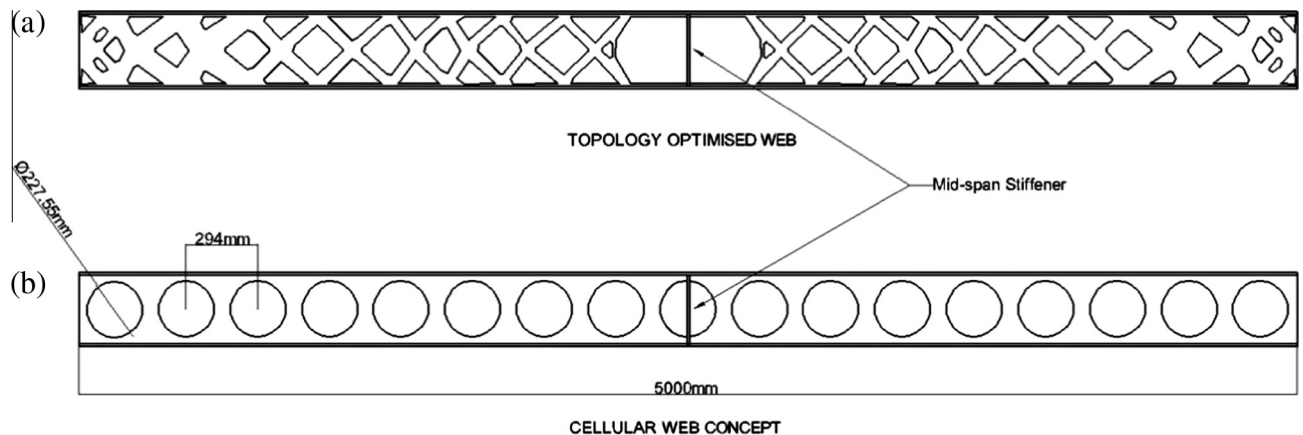

Fig. 6. Beam models compared: (a) topology optimised beam web design, (b) cellular beam design.

4.4.2. FE model

Cellular beams often exhibit complex structural behaviour including localised buckling modes or yielding and redistribution

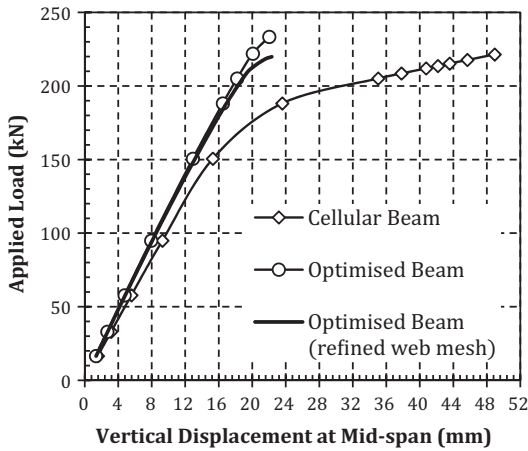

Fig. 7. Comparison of load versus mid-span deflection for cellular beam and topology optimised beam.

of stresses around the openings. A FE technique has been previously presented [43] that can capture these complex failure modes. The basis of the FE analysis technique employed is a three-step process whereby an initial pre-stress was applied to the model and a linear static analysis was performed. The results of the linear static analysis were then used in an Eigenvalue analysis to determine the first buckling frequency and the associated mode shape. Imperfections were then applied to the FE mesh, using the mode shape which was taken from the Eigenvalue analysis, with a magnitude of the web thickness divided by 200. A geometric and materially nonlinear FE analysis is finally performed to determine the load at which the beam will buckle. The analysis was performed using the solver of the FE package of ANSYS. A full detailed description of the technique, along with a verification of the results against experimental data, can be found in [44].

The Young's Modulus, Poisson Ratio, Yield Stress and Tangent Modulus were defined as 200 GPa, 0.3, 355 MPa and 2000 MPa, respectively, using a bi-linear elasto-plastic material model.

4.4.3. FE study

The topology optimised beam web design was compared with a cellular type beam with an identical UB 305 × 165 × 40 cross-section. To compare the relative efficiency of the beams, in terms of material usage against load capacity, the cellular beam

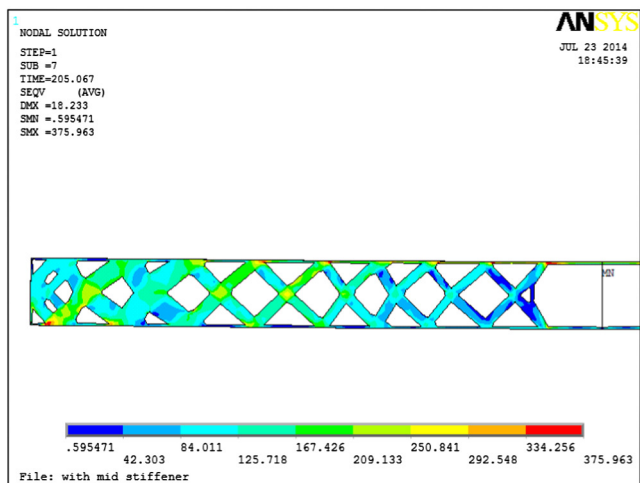
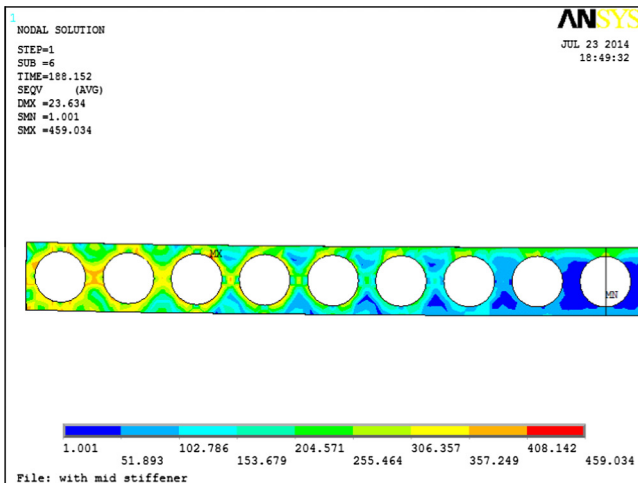

Fig. 8. Von Mises stress plots for cellular and topology optimised beams at yield load level.

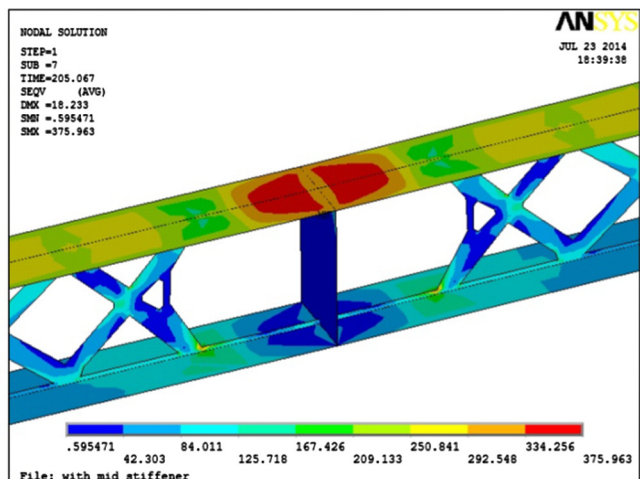
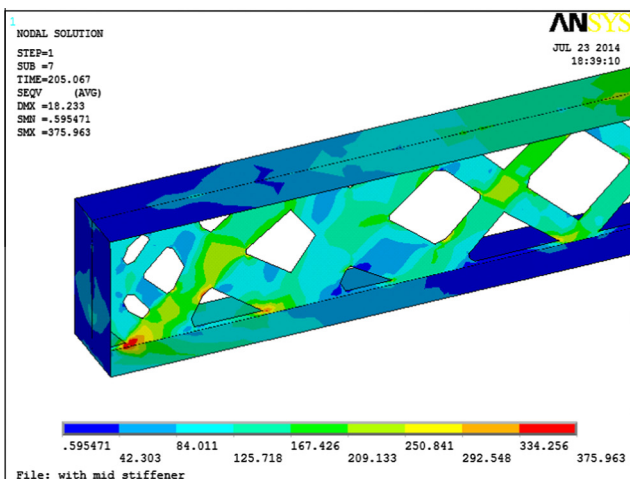

Fig. 9. Localised stress concentrations observed at yield load in cellular beam: (left) support, (right) mid-span.

was specified such that its mass is as similar as possible to the mass of the optimised beam (Fig. 6). A typical opening depth of 0.75 times the web depth was specified, with openings at regular 294 mm intervals. If the density of steel is taken as a typical value of 7850 kg/m<sup>3</sup>, the weight of the topology optimised beam is 169.87 kg, whilst the one of the cellular beam is 173.64 kg, hence only a 2.17% percentage of difference.

In both cases, a stiffener was provided at mid-span in order to more effectively transfer the shear forces between the top and bottom flange of the beam. This practice was proved appropriate particularly for the optimised beam, where there is a wide large web gap at the mid-span, which can cause localised stresses in the beam flanges due to high bending. Moreover, it was a prerequisite that the design of the cellular beam should follow the current specifications in terms of web opening size and spacing and early failure is not anticipated. In the case of the topology optimised design, it was found to be necessary to manually refine the FE mesh to prevent divergence of the solution due to highly distorted elements.

#### 4.4.4. Results

The yield load of the cellular beam is found to be 188.15 kN with a corresponding deflection of 23.58 mm. The yield load of the optimised beam is found to be 207.96 kN with a corresponding deflection of 19.21 mm. The expected ultimate load of the optimised beam is also going to be higher than the cellular beam. Load against mid-span deflection plots for the analyses (Fig. 7) show that the optimised beam is stiffer than the cellular beam in the linear region. It is worth to note that the analyses with the optimised models stopped suddenly due to high stress concentrations at the mid-span of the beam sections. Healing the non-convergence issue at this stage in order to capture the post-elastic behaviour of the beams is beyond the scope of this study, as the stiffness and yielding loads are essentially compared. In addition, such a weak design at the mid-span of the optimised beam is not anticipated to be used in practice.

Von Mises stress plots (Figs. 8 and 9) for both examined beams at the yield load level, show that despite some high localised stress concentrations in the optimised beam due to corners resulted from the openings' shape, the stress distribution is generally more uniform. In contrast stresses in the cellular beam tend to increase significantly towards the supports, and therefore the connections.

It is further observed that the cellular beam suffered a localised buckling failure in the web-posts towards the support. On the other hand, the primary failure mode of the optimised beam is difficult to be concluded from this preliminary investigation. Localised buckling within the web depth is observed at failure. Also, high stress concentrations in the vicinity of the large central web opening are found, whilst both of these features are observed to occur concurrently.

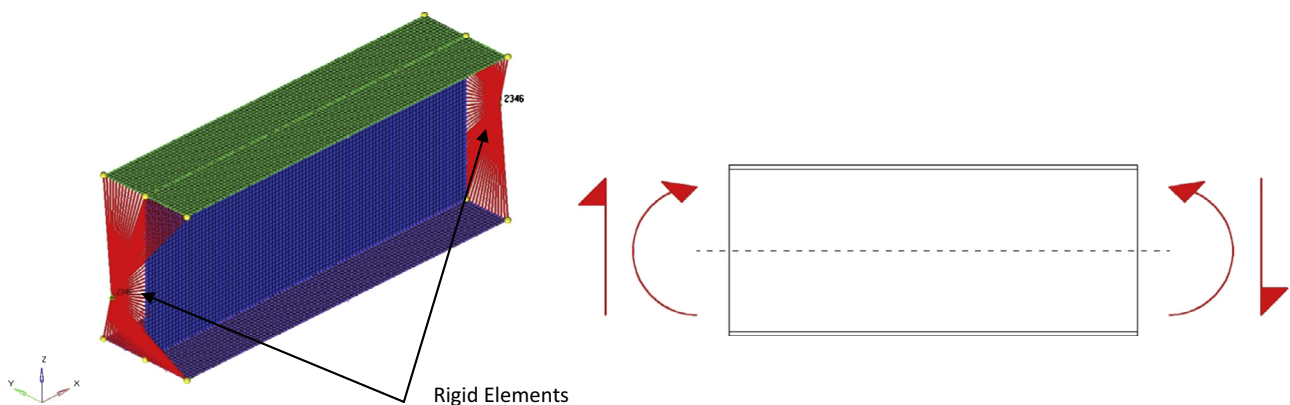

Fig. 10. FE model and loading approach taken in parametric study.

Table 1

Illustrative example of compliance weighting calculation.

	Load case		
	Moment	Shear	Moment-shear
Compliance of plain webbed section	97,951	33,177	61,237
Weighting	0.509	0.172	0.318

Table 2

Sections used in topology optimisation studies considering variation to section depth.

Length (mm)	Breadth (mm)	Depth (mm)	Flange thickness (mm)	Web thickness (mm)
576	150	240	6	10
648	168.75	270	6	10
720	187.5	300	6	10
960	250	400	6	10
1344	350	560	6	10
1680	437.5	700	6	10
2160	562.5	900	6	10

Table 3

Sections used in topology optimisation studies considering variations in flange thickness ratios.

Length (mm)	Breadth (mm)	Depth (mm)	Flange thickness (mm)	Web thickness (mm)
960	250	400	6	10
960	250	400	10	10
960	250	400	15	10
960	250	400	20	10
960	250	400	25	10
960	250	400	30	10

#### 4.5. Discussion

The web design of an I-section steel beam is developed using topology optimisation. When compared to a conventional cellular beam, it was found that the topology optimised beam has advantageous structural behaviour in terms of the initial stiffness, the yield load, and the stress profile. The investigation was therefore considered to be an effective proof of concept demonstrating that there are more effective ways of distributing the material within the beam web depth in order to enhance the structural performance of a lightweight perforated section.

It is worth mentioning that the effort required to develop the topology optimised beam web design was not trivial. It would be necessary to perform such lengthy topology optimisation, geometry extraction and load verification procedure for every new section, span or load combination considered. Moreover, the load



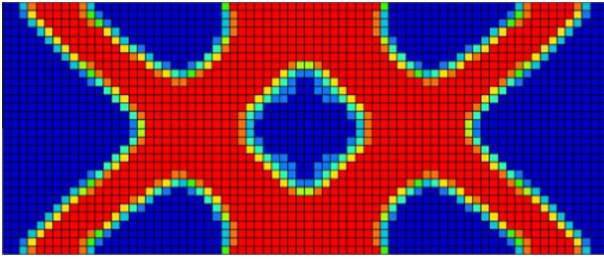

Fig. 11. Identification of generalised opening type from topology optimisation studies on short section of beam.

capacity of the optimised beam web cannot be verified using standardised design equations due to the complexity of the new geometry.

### 5. Development of a topologically optimum web opening type

In light of the observations detailed above, it was concluded that the topology optimisation is a useful tool for identifying alternative improved beam web opening designs. However, when it was applied to a full length beam, the resulting design was rather complex and difficult to apply in a general sense.

In order to establish a topologically optimum opening architecture that can be applied to all beam cross-sections and positioned at any location along the length of the beam, a local modelling

approach was followed. Rather than considering a full length beam with externally applied loading, a short section of a beam was modelled and internal shear and bending moments were applied directly to the section. This approach enables a wide variety of cross-sections to be investigated, and results in a new opening type that could be utilised generally.

#### 5.1. Parametric topology optimisation approach

A FE model of a short beam section was developed. Loading was applied to the model in the form of bending moments and shear forces. Rigid elements were used in the application of the bending moment and shear force (Fig. 10).

Three load cases were considered in the topology optimisation: (i) bending moments only, (ii) shear forces only, and (iii) a combination of shear forces and bending moments.

A weighted compliance approach was established when considering the three load cases in the optimisation. The weighting for each of the individual compliances was defined relative to the compliance of the plain webbed section subject to each of the load cases. The process of determining the weightings for an illustrative example is summarised in Table 1.

The parameters varied were the depth of the section and the ratio of flange and web thickness. Full details of all of the cross-sections considered in the parametric study of the depth variation (Table 2) and the flange ratio variation (Table 3) are included.

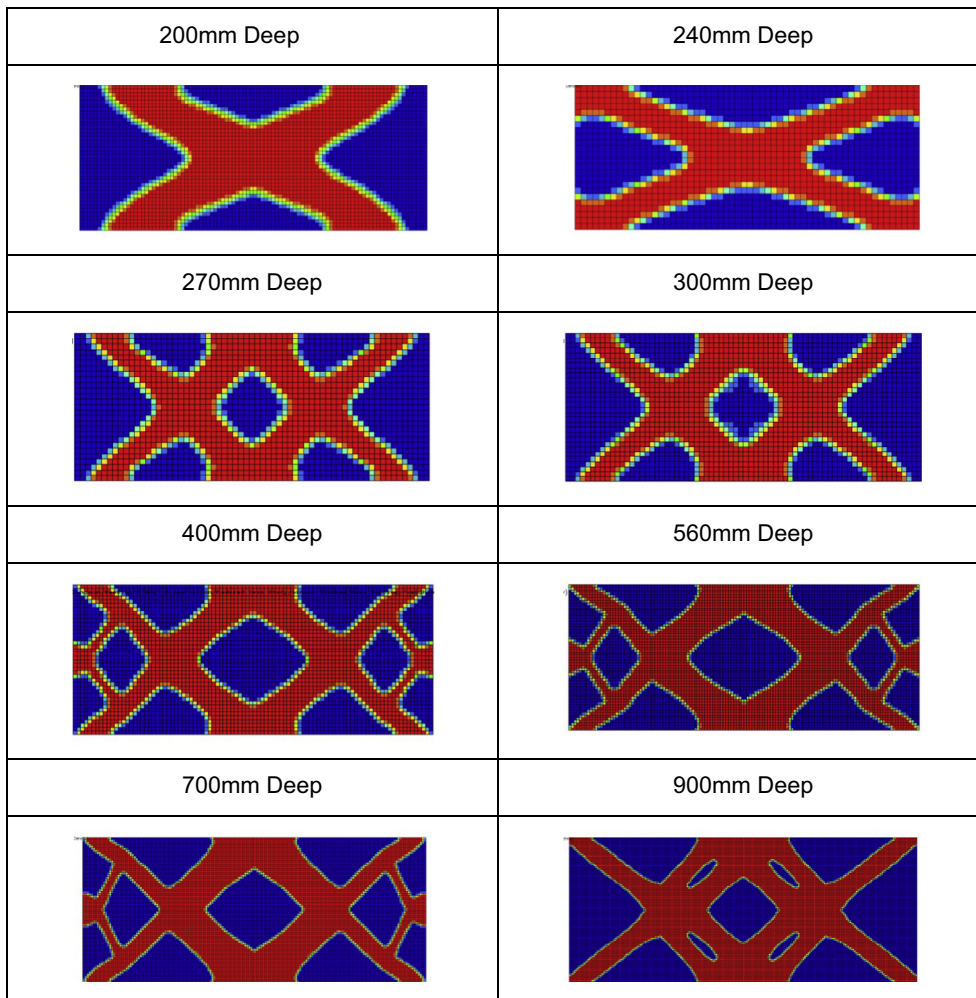

Fig. 12. Results of parametric topology optimisation studies considering variations in beam depth.

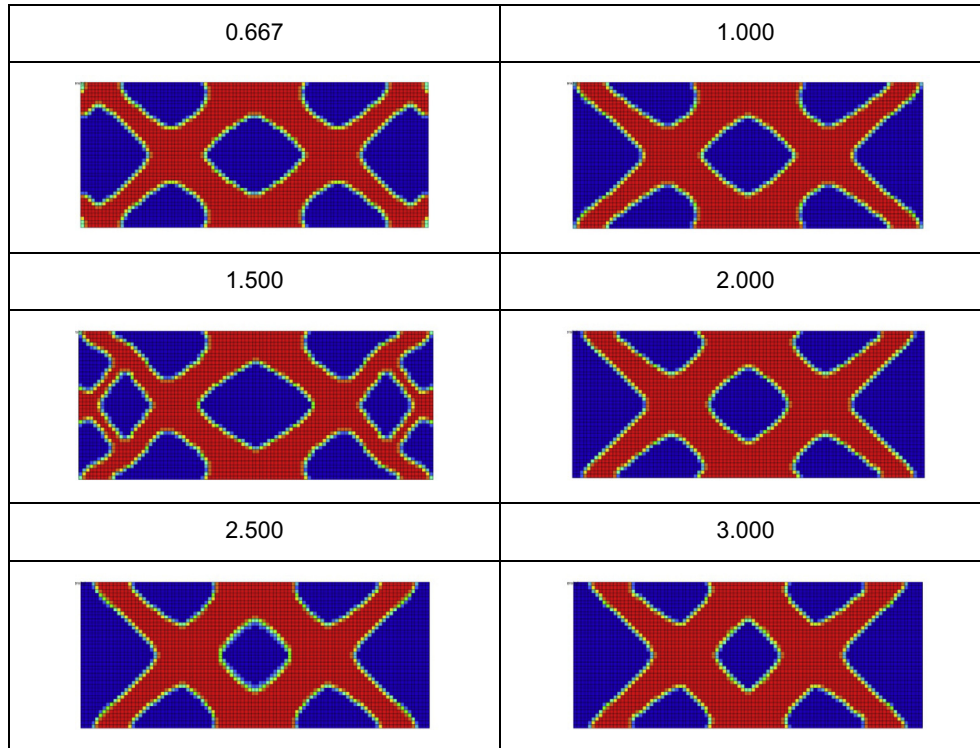

Fig. 13. Results of parametric topology optimisation studies considering variations in ratio of flange thickness to web thickness.

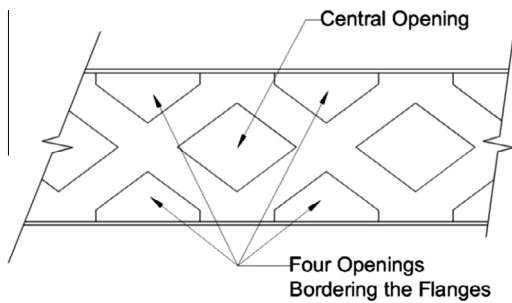

Fig. 14. Suggested topologically optimum web opening concept.

5.2. Discussion

It should be noted that when interpreting the results of the topology optimisation studies, only the opening pattern emerging in the centre of the beam (Fig. 11) is of interest in terms of developing a web opening type that could be periodically applied along the length of the beam.

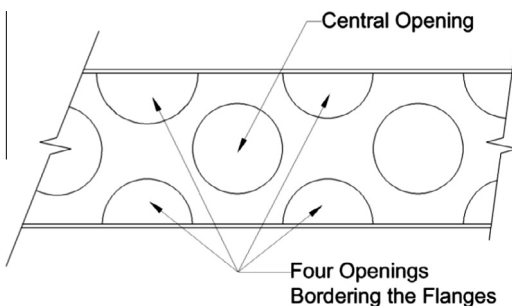

Fig. 15. Alternative interpretation of topologically optimum web opening concept.

It was found that the ratio of the flange thickness to the web thickness did not alter the resulting optimal topology, but the actual shape of the suggested web opening was altered (Fig. 12). The depth of the section did have an impact on the optimal topology (Fig. 13). In the depth range between 270 mm and approximately 750 mm, it was found that the optimal opening topology was consistent. For shallower beams, it was found that an elongated cross shape was the most efficient design. In the case of beams deeper than 750 mm, extra openings were recommended by the topology optimisation results to keep a balance between stiffness and weight.

The consistency of the results in the depth range between 270 mm and 750 mm indicate that the same topology is optimal for most of beam sections that may be found in practice.

5.3. Topologically optimum web opening architecture

Based on the results of the parametric studies, an optimum web opening type has been developed (Fig. 14). It should be noted that this optimum topology may be interpreted using various opening

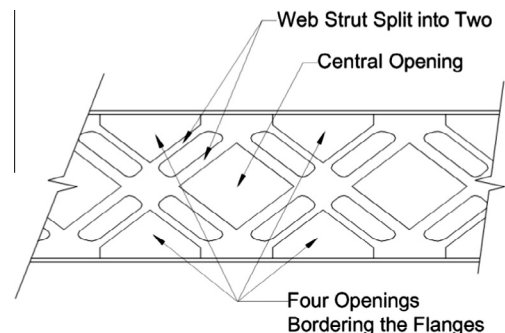

Fig. 16. Topologically optimum web opening concept for beam greater than 750 mm deep.

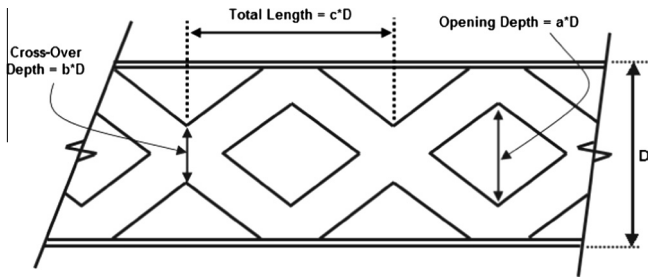

Fig. 17. Key geometric parameters of suggested beam web opening concept and beam web geometry defined as functions of beam depth.

shapes, such as circular openings depicted in Fig. 15. It is anticipated that a shape optimisation study would further yield valuable information regarding the optimum shape of the openings.

The concept of this opening architecture is suggested to be topologically optimal for all beam cross-sections in the depth range between 270 mm and 750 mm. In the case of beams deeper than 750 mm deep, an alternative opening architecture is recommended as being topologically optimal (Fig. 16).

It is aforementioned that it would not be possible to create beams with the suggested web opening topologies using the profile cutting procedure. However, it would be possible to create such beams based on the plate assembly method of fabrication. This conforms to the current trends of the leaders in steel fabrication industry (eg. Fabsec, ASD Westok, ArcelorMittal, and Macsteel), in which the plated beam design is now vastly utilised and promoted to accommodate architects' and designer's needs. It is worth to notify that the reduced connectivity of the web to the flanges due to the top and bottom edge web openings implied a rather high sensitivity to torsional loads. This unwanted structural behaviour can be limited by the use of an additional strip of steel at the top and bottom edges of the web plate, similarly to the result from the full length model (Figs. 8 and 9).

## 6. Shear buckling study of the short beam section

A new beam web design configuration is suggested based on the results of the topology optimisation investigations performed so far. A detailed description of the suggested beam web configuration is given and a preliminary investigation into the behaviour and performance of the new beam web design is presented herein.

### 6.1. Geometric properties

An interpretation of the optimal topology is presented and a description of the key geometric parameters is given (Fig. 17). It should be noted that this particular interpretation was made due to its simplicity as an initial investigation. It is expected that future studies may investigate alternative opening architectures and configurations while the scope of this research is to introduce the concept and highlight the steps that need to be followed to establish the new designs.

Table 4  
Material properties.

Parameter	Experimentally determined		Nominal
	Web	Flange/Stiffeners	
Young's Modulus (N/mm <sup>2</sup> )	200,000	200,000	200,000
Yield stress (N/mm <sup>2</sup> )	375.30	359.70	355.00
Ultimate stress (N/mm <sup>2</sup> )	492.70	480.90	510.00
Tangent Modulus (N/mm <sup>2</sup> )	580	580	580

The three key geometric parameters (Fig. 17) are defined as multiples of the beam depth. The value of "a" defines the depth of the large central opening as a multiple of beam depth, D. The value of "b" defines the depth of the cross-over of the web struts as a multiple of D. Finally "c" describes the "aspect ratio" of the openings as a multiple of D. It is therefore possible to fully describe the geometry of the beam web openings through a combination of the values a, b, and c.

### 6.2. Buckling behaviour

The initial study into the behaviour of beams with the newly suggested web opening architecture focused on web buckling behaviour under shear loading. The purpose of this initial investigation is to determine how the buckling behaviour of the topology optimised web opening concept behaves and later compares to that of cellular, castellated and other perforated beams with novel configurations. A local approach, considering only a short section of the beam web, is taken as only local instabilities are of interest hereby.

### 6.3. FE analysis

The buckling behaviour of beam webs with openings under shear loading is known to be complex [43]. A materially and geometric nonlinear FE analysis approach was implemented to determine the buckling load of the beam web. A three-step analysis approach, similar to that previously utilised in the analysis of the full length topology optimised beam, is implemented to determine the buckling load of the beam web. Radioss, a FE solver also developed by Altair Engineering, was used in the analysis of the topology optimised web opening. The model developed uses four-node quadrilateral shell elements with six degrees of freedom (6DOF) at each node. The Batoz–Dhatt shell element formulation was used in the nonlinear analysis. The automesh function, available within Hypermesh, was used to generate the FE mesh. A nominal element size of 10 mm was specified to ensure a sufficient number of elements within the depth of the web to accurately model the behaviour of the beam. A bilinear elasto-plastic material model, with post-elastic strain hardening, was specified. Details of the parameters used in the material model can be found in Table 4 and Tsavdaridis and D'Mello [43]. A linear static analysis, using a unit load applied in the location of the applied load, was the first

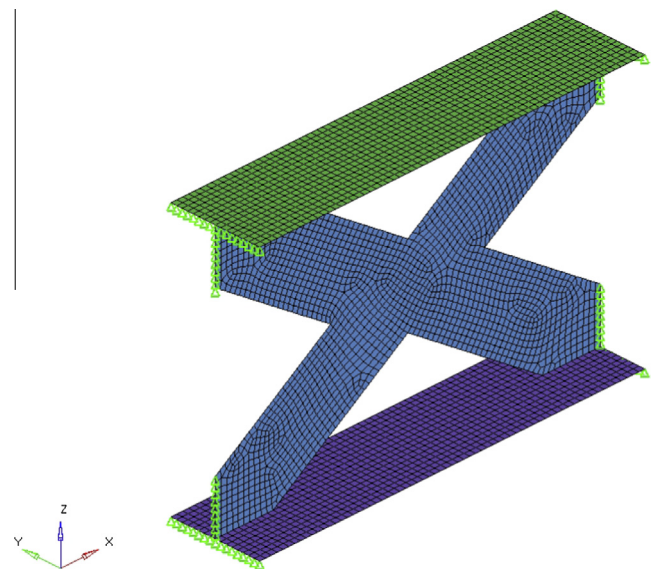

Fig. 18. Local model developed for topology optimised web concept buckling study.



**Table 5**  
Constraints applied to local model for topology optimised web buckling study.

Part	Constraints
Left side flanges	Translation: $x$ and $z$ Rotation: $x$ and $y$
Left side web	Translation: $x$ , $y$ and $x$ Rotation: $x$ and $z$
Right side flanges	Translation: $y$ Rotation: $x$ , $y$ and $z$
Right side web	Translation: $y$ Rotation: $y$ and $z$

step in the analysis process. An Eigenvalue analysis was subsequently performed. The Block Lanczos method is used to extract the Eigenvalues. The five lowest Eigenvalues and associated buckling modes were requested. Following the computation of the Eigen modes, geometric imperfections were applied to the FE mesh. The imperfections were applied in the direction of the Eigen mode as extracted by the lowest Eigenvalue. The magnitude of the imperfections was defined as the thickness of the web divided by 200 following recent studies [44]. A nonlinear static analysis was finally performed using the FE mesh including imperfections. Monotonically increasing loading is applied to the FE model. The modified Newton-Raphson method is used to solve the nonlinear problem at each loading increment. The convergence criterion was defined as total work with a tolerance of 0.01. Automatic time-step control, based on the arc-length method, was used to control and speed the convergence of the analysis.

#### 6.4. Local model

It has been shown that a local modelling approach is the most effective one when attempting to determine the web buckling

behaviour of beams with web openings [44]. The local model (Fig. 18) represents a section of the beam from centreline to centreline of centrally positioned web openings. Constraints are cautiously applied to the ends of the beam section to conservatively replicate the restraint which would be present in a full length beam. A summary of the constraints is given in Table 5. Shear force is applied only to the web of the local beam model.

#### 6.5. Parametric study

The topology optimised beam web architecture differs significantly to previously investigated web opening designs. It was therefore decided to perform a parametric study investigating as a wide range of topology optimised web opening configurations. A total of 96 models were examined. The depth of the large central opening was varied between 0.5 and 0.8 times the beam depth with increments of 0.1. The depth of the cross-over was varied between 0.1 times the beam depth and 0.8 times the beam depth in increments of 0.1. Values of 1.0, 1.5, and 2.0 times the beam depth were investigated for the value of  $c$ . A full summary of all of the configurations used in the parametric study can be found in Table 6.

The same beam cross-section, a standard  $457 \times 152 \times 52$  UB, was used in all of the studies. This section was selected on the basis that previous studies [6,8,43], considering the web buckling of alternative opening types, have been performed using this particular cross-section. Comparisons between the buckling behaviour of the topology optimised web opening configuration and currently used opening types is therefore possible.

#### 6.6. Results

Each of the web configurations described was analysed using the Radioss FEM. The buckling load was defined as the point at

**Table 6**  
Summary of all of the combinations of parameters  $a$ ,  $b$  and  $c$ .

Test reference	$a$	$b$	$c$	Buckling load (kN)	Test reference	$a$	$b$	$c$	Buckling load (kN)	Test reference	$a$	$b$	$c$	Buckling load (kN)
1	0.5	0.1	1	215.81	33	0.5	0.1	1.5	110.58	65	0.5	0.1	2	74.5
2	0.5	0.2	1	232.52	34	0.5	0.2	1.5	157.16	66	0.5	0.2	2	104.8
3	0.5	0.3	1	289.16	35	0.5	0.3	1.5	216.09	67	0.5	0.3	2	144.59
4	0.5	0.4	1	370.3	36	0.5	0.4	1.5	287.59	68	0.5	0.4	2	205.74
5	0.5	0.5	1	415.74	37	0.5	0.5	1.5	373.74	69	0.5	0.5	2	282.02
6	0.5	0.6	1	452.28	38	0.5	0.6	1.5	419.62	70	0.5	0.6	2	359.02
7	0.5	0.7	1	476.38	39	0.5	0.7	1.5	467.9	71	0.5	0.7	2	368.67
8	0.5	0.8	1	482.17	40	0.5	0.8	1.5	455.37	72	0.5	0.8	2	366.02
9	0.6	0.1	1	157.54	41	0.6	0.1	1.5	107.92	73	0.6	0.1	2	67.51
10	0.6	0.2	1	225.16	42	0.6	0.2	1.5	145.16	74	0.6	0.2	2	95.8
11	0.6	0.3	1	281.45	43	0.6	0.3	1.5	205.09	75	0.6	0.3	2	139.09
12	0.6	0.4	1	331.59	44	0.6	0.4	1.5	276.59	76	0.6	0.4	2	193.74
13	0.6	0.5	1	370.09	45	0.6	0.5	1.5	365.91	77	0.6	0.5	2	268.02
14	0.6	0.6	1	391.74	46	0.6	0.6	1.5	351.02	78	0.6	0.6	2	317.02
15	0.6	0.7	1	397.74	47	0.6	0.7	1.5	352.02	79	0.6	0.7	2	303.02
16	0.6	0.8	1	427.44	48	0.6	0.8	1.5	352.02	80	0.6	0.8	2	303.02
17	0.7	0.1	1	133.16	49	0.7	0.1	1.5	91.57	81	0.7	0.1	2	57.01
18	0.7	0.2	1	199.3	50	0.7	0.2	1.5	129.16	82	0.7	0.2	2	82.3
19	0.7	0.3	1	251.45	51	0.7	0.3	1.5	183.09	83	0.7	0.3	2	125.9
20	0.7	0.4	1	314.03	52	0.7	0.4	1.5	243.59	84	0.7	0.4	2	175.74
21	0.7	0.5	1	361.35	53	0.7	0.5	1.5	252.87	85	0.7	0.5	2	233.02
22	0.7	0.6	1	319.74	54	0.7	0.6	1.5	282.02	86	0.7	0.6	2	240.02
23	0.7	0.7	1	324.4	55	0.7	0.7	1.5	282.02	87	0.7	0.7	2	240.02
24	0.7	0.8	1	324.02	56	0.7	0.8	1.5	285	88	0.7	0.8	2	240.02
25	0.8	0.1	1	108.12	57	0.8	0.1	1.5	70.72	89	0.8	0.1	2	42.87
26	0.8	0.2	1	158.08	58	0.8	0.2	1.5	105.87	90	0.8	0.2	2	69.16
27	0.8	0.3	1	233.85	59	0.8	0.3	1.5	149.8	91	0.8	0.3	2	105.16
28	0.8	0.4	1	248.24	60	0.8	0.4	1.5	185.8	92	0.8	0.4	2	146.45
29	0.8	0.5	1	256.51	61	0.8	0.5	1.5	206.45	93	0.8	0.5	2	170.42
30	0.8	0.6	1	245.36	62	0.8	0.6	1.5	217.74	94	0.8	0.6	2	181.74
31	0.8	0.7	1	248.88	63	0.8	0.7	1.5	223.74	95	0.8	0.7	2	193.74
32	0.8	0.8	1	219.02	64	0.8	0.8	1.5	229.74	96	0.8	0.8	2	193.74



which the maximum out-of-plane displacement of the beam web reached a value of 0.2 mm as this was observed to be the point at which the out-of-plane displacement rapidly increased indicating a buckling failure (Fig. 19). Also, it can be observed that the higher is the total length,  $c$ , the more linear proved to be the buckling load capacity evaluation when ranging the cross-over depth,  $b$  (Fig. 19 – polynomial trends presented).

6.7. Discussion

It was found that as the depth,  $a$ , of the large central opening is increased the buckling load capacity of the beam web reduces. It was also found that as the width,  $c$ , is increased, the buckling load of the beam web is also reduced. These relationships are intuitively correct.

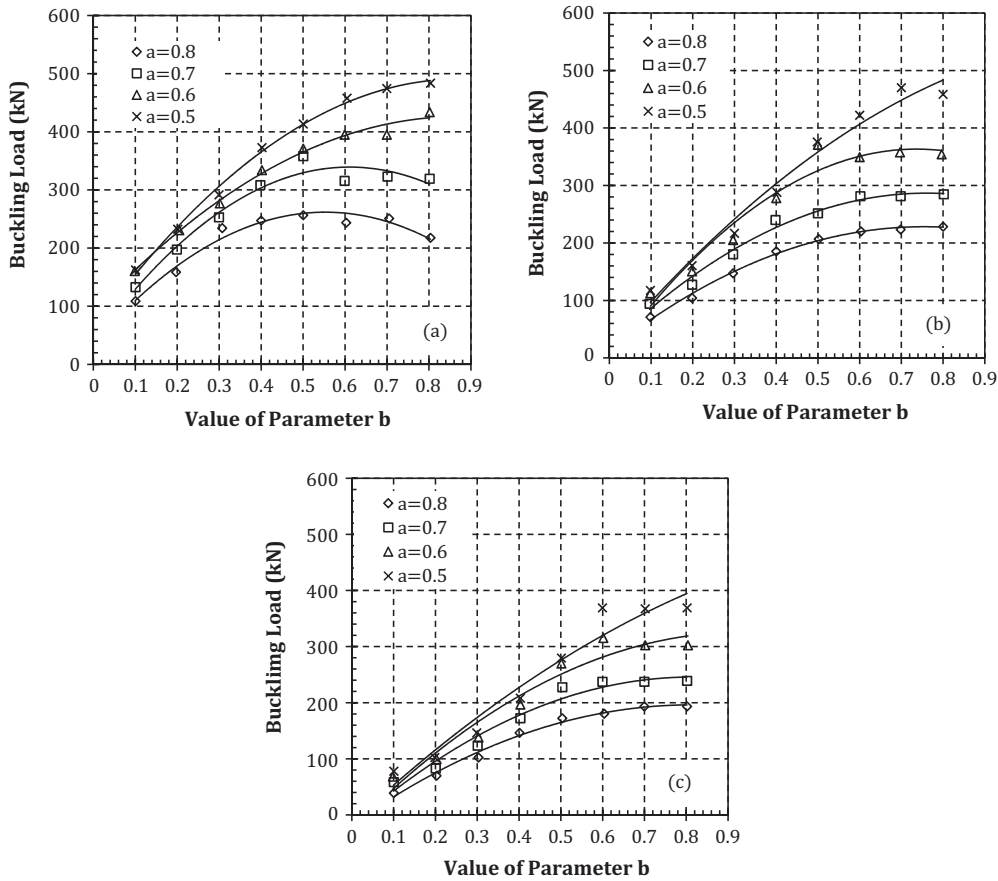

Fig. 19. Shear buckling capacities: (a) parameter  $c = 1.0$ , (b) parameter  $c = 1.5$ , (c) parameter  $c = 2.0$ .

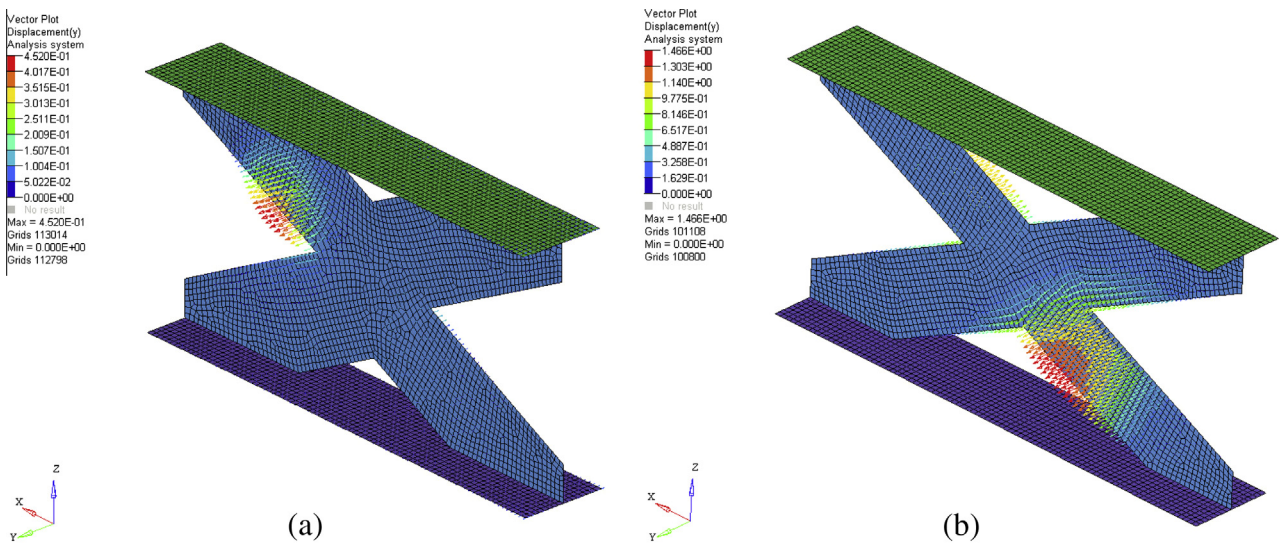

Fig. 20. Out-of-plane displacement vectors: (a) buckling along edge of central opening in test 96, (b) buckling along edge of perimeter opening in test 94.

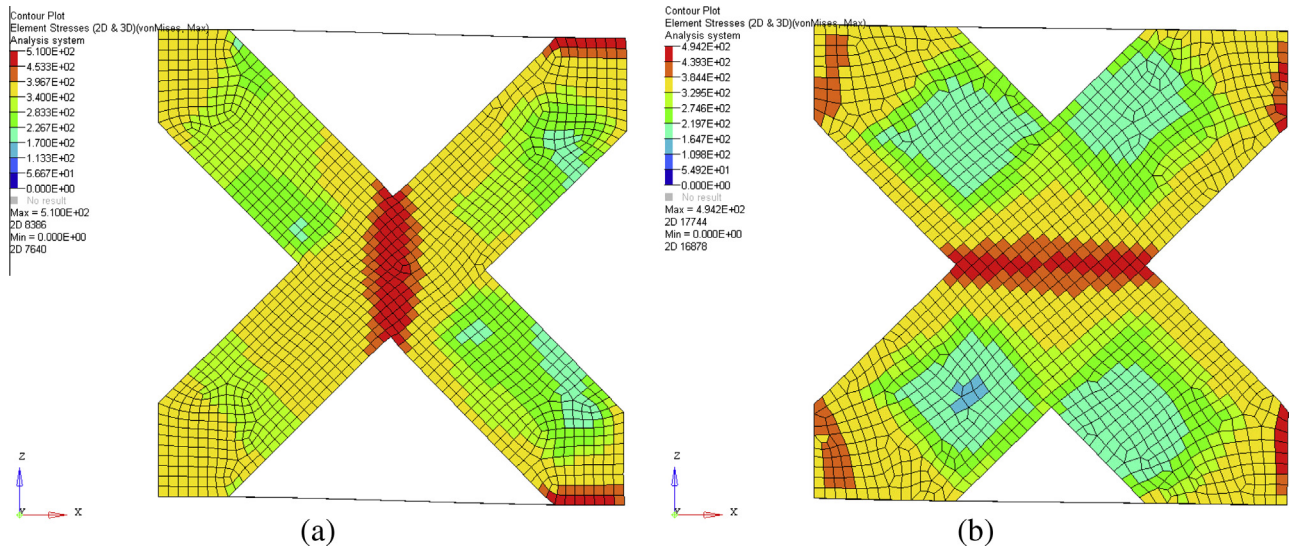

Fig. 21. Von Mises stress plots for: (a) test 11, (b) test 14.

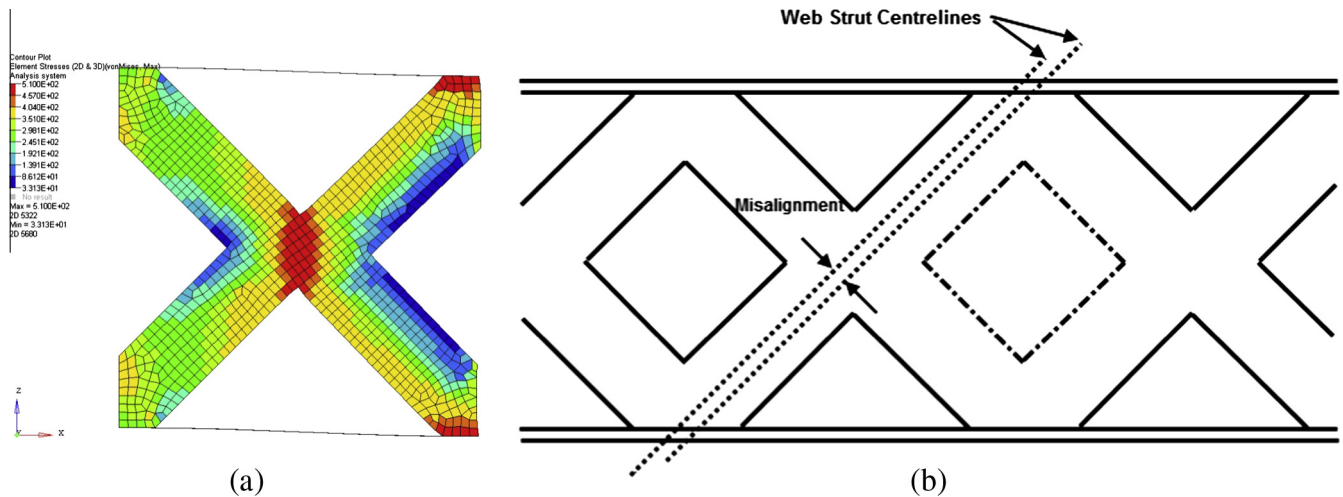

Fig. 22. (a) Misalignment of web struts, (b) resulting uneven stress distribution across the breadth of the web strut.

The relationship between the depth,  $b$ , of the cross-over and the buckling load is more complex. It was concluded that the relationship between the cross-over depth and the buckling load is approximately linear until a limiting value is reached, at which point the buckling load tends to an approximately constant value. For the web configurations investigated, it was estimated that the cross-over depth at which the buckling load tends to a constant value was between 0.5 and 0.6 times the beam depth.

The limiting shear buckling capacity was reached when the web buckled along the edge of the central web opening (Fig. 20a) rather than the edge of the perimeter opening (Fig. 20b). It can be concluded from this that if the edge length of the perimeter opening is maintained below the edge length of the central opening the shear buckling capacity of the web will not be altered.

Significant yielding and distortion of the web in the cross-over area zone (Fig. 21) was observed in tests 1–32 from Table 4, where the value  $c$  was defined as 1.00, prior to the buckling load being reached. This would indicate that the critical failure mode in these instances is not the web buckling, but a Vierendeel type failure which cannot be accurately modelled using the local study approach [45].

In the course of the parametric study a major limitation of this topology optimised beam web architecture, as currently described, was identified. It became apparent that the method of defining the geometry of the topology optimised beam web leads to misalignment of the web struts across the cross-over point (Fig. 22). This misalignment of the web struts generates an uneven stress distribution across the breadth of the strut. The resulting increased stress towards the edge of the opening, promotes a premature buckling along the web opening.

Consequently, it is recommended that a future study is conducted to investigate the impact of aligning the web struts. It is anticipated that alignments of the web struts will enhance the buckling characteristics of the beam web.

## 7. Limitations and concluding remarks

The application of structural topology optimisation techniques to the design of steel I-section perforated beams has been investigated for the first time. A web opening design for a 5 m span universal beam section was developed using the solid isotropic material with the penalisation technique of topology optimisation. A geometric and material nonlinear FE analysis, using ANSYS, was

employed in order to predict the load carrying capacity of the topology optimised beam. It was found that when compared to a cellular type beam, the optimised design had increased stiffness and yield load. Various restrictions to the routine application of topology optimisation, including the complexity of the web geometry as well as the analysis difficulties, were highlighted. It is expected that different depth-to-span ratios will result different web opening patterns of a similar architecture developed by the topology optimisation study.

Thereafter, a parametric topology optimisation study has been performed on a short section of a beam in order to develop a topologically optimum web opening architecture for the wide variety of beam cross-sections that may be found in practice. An optimum web opening architecture has been developed (Figs. 14 and 15), whilst it is effective for beams of depth between 270 mm and 750 mm. An alternative optimum web opening architecture is suggested for beams deeper than 750 mm (Fig. 16). This initial suggestion is made as to potential shapes for the web openings, and their geometry is described as a function of beam depth. It is envisaged that this short section with a web opening architecture can be then repeated to form a beam of any span.

Furthermore, the shear buckling behaviour of the suggested short section web architecture was investigated using nonlinear FE buckling analysis, and a comprehensive parametric study was conducted to investigate a wide range of possible configurations. It was observed that the optimised section has a higher buckling capacity, when subjected to shear load, compared to a cellular section of the same weight.

Due to certain limitations, further work is anticipated to focus on the optimisation of the opening shapes to be employed in the topologically optimum web opening architecture. Investigations of the ultimate load carrying capacities and the associated failure modes of the topologically optimum web opening configurations are deemed necessary. Following preliminary analyses, it was considered of paramount importance to investigate the results of various complex loading and support conditions as well as depth-to-span ratios which may trigger other failure modes. Similarly to the design of cellular, castellated, and other perforated beams with various standard and non-standard web opening shapes, the diversity of loading and supports conditions is to be dealt in the beam design process as well as introducing web and flange stiffeners and/or using partial factors. In case of a steel frame structure is considered, the engineer is able to use the optimised beams as formed by the periodical position of the short sections, and treat each beam of the frame whilst using its equivalent static properties assuming constant cross-section along its length (Euler beam theory). The ultimate aim of this research project is the development of design equations that can be used in the routine design of beams employing such optimum web opening configurations.

The cost of such optimised beams is related to the cost of the steel used (plus the scrap metal) as well as the manufacturing process. Cost analysis has not been introduced in this paper since the new opening architecture is not yet finalised.

## Acknowledgements

The first author, Dr. K.D. Tsavdaridis, would like to thank J.J. Kingman for the work that he conducted during his MEng thesis at the University of Leeds (2012–13) under his and Prof. V.V. Toropov's supervision. He would like to acknowledge the contribution of the EPSRC DTG CASE (201324) and ASD Westok Ltd. for their generous support. The authors would also like to thank Dianzi Liu for the technical assistance on the use of Hypermesh and Optistruct software packages and Luca Frattari of Altair Engineering Inc. for the assistance on the post-processing of the results.

## References

- [1] Knowles PR. Castellated beams. *Proc Inst Civ Eng* 1991;90:521–36.
- [2] Redwood RG. The strength of steel beams with unreinforced web holes. *Civil Eng Public Works Rev* 1969;64:559–62.
- [3] Kerdal D, Methercot DA. Failure modes of castellated beams. *J Constr Steel Res* 1984;4:295–315.
- [4] Hosain MU, Speirs WG. Experiments on castellated beams. *J Am Weld Soc* 1973;52(8):329–42.
- [5] Ward JK. Design of composite and non-composite cellular beams (P100). Ascot: Steel Construction Institute; 1990.
- [6] Chung KF, Liu TCH, Ko ACH. Investigation on Vierendeel mechanism in steel beams with circular web openings. *J Constr Steel Res* 2001;57:467–90.
- [7] Tsavdaridis KD, D'Mello C. Optimisation of novel elliptically-based web opening shapes of perforated steel. *J Constr Steel Res* 2012;76:39–53.
- [8] Tsavdaridis KD, D'Mello C. Vierendeel bending study of perforated steel beams with various novel shapes of web openings, through non-linear finite element analyses. *J Struct Eng – ASCE* 2012;138(10):1214–30.
- [9] Durif S, Bouchair A, Vassart O. Experimental tests and numerical modeling of cellular beams with sinusoidal openings. *J Constr Steel Res* 2013;82:72–87.
- [10] Wang P, Ma Q, Wang X. Investigation of Vierendeel mechanism failure of castellated steel beams with fillet corner web openings. *Eng Struct* 2014;74:44–51.
- [11] Vassart O. Development of a new type of composite cellular beam. *Singapore Eng* 2008;3:14–6.
- [12] Erdal F, Doğan E, Saka MP. Optimum design of cellular beams using harmony search and particle swarm optimizers. *J Steel Constr Res* 2011;67:237–47.
- [13] BS5950-1:2000. Structural use of steelwork in building. Code of practice for design, rolled and welded sections.
- [14] Lagaros ND, Psarras LD, Papadrakakis M, Panagiotou G. Optimum design of steel structures with web openings. *Eng Struct* 2008;30:2528–37.
- [15] Kingman JJ, Tsavdaridis KD, Toropov VV. Application of topology optimisation to the design of steel I-section webs. In: The 14th international conference of civil, structural and environmental engineering computing, 3–6 September. Cagliari, Sardinia, Italy; 2013. <http://dx.doi.org/10.4203/ccp.102.223>.
- [16] Christensen PW, Klarbring A. An introduction to structural optimisation. Sweden: Springer Science & Business Media B.V.; 2009.
- [17] Belegundu AD, Chandrupatal TR. Optimisation concepts and applications in engineering. 2nd ed. New York: Cambridge University Press; 2011.
- [18] Engineering Science and Physical Research Panel. EPSRC review of UK academic research in ground and structural engineering; 2009.
- [19] Nolan J. Cost versus value – the role of the consulting engineer. *Struct Eng* 2012;90(2):20–1.
- [20] Xie YM, Steven GP. An evolutionary procedure for structural optimisation. *Comput Struct* 1993;49(5):885–96.
- [21] Eschenauer HA, Kobelev HA, Schumacher A. Bubble method for topology and shape optimisation of structures. *Struct Multidiscipl Optim* 1994;8(1):42–51.
- [22] Wang MY, Wang X, Guo D. A level set method for structural topology optimisation. *Comput Methods Appl Mech Eng* 2003;192(1–2):227–46.
- [23] Norato JA, Bendsoe MP, Haber RB, Tortorelli DA. A topological derivative method for topology optimisation. *Struct Multidiscipl Optim* 2007;22(4–5):375–86.
- [24] Michell AGM. The limits of economy of material in frame structures. *Phil Mag* 1904;8(6):589–97.
- [25] Rozvany GIN, Prager W. Optimal design of partially discretised grillages. *J Mech Phys Solids* 1976;24(2/3):125–36.
- [26] Lewinski T, Rozvany GIN. Exact analytical solutions for some popular benchmark problems in topology optimisation II: three-sided polygonal supports. *Struct Multidiscipl Optim* 2007;33(4–5):337–50.
- [27] Lewinski T, Rozvany GIN. Exact analytical solutions for some popular benchmark problems in topology optimisation III: L-shaped domains. *Struct Multidiscipl Optim* 2008;35(2):165–74.
- [28] Rozvany GIN. A critical review of established methods of structural and topology optimisation. *Struct Multidiscipl Optim* 2008;37(3):217–37.
- [29] Rossow MP, Taylor JE. A finite element method for the optimal design of variable thickness sheets. *AIAA J* 1973;11(11):1566–9.
- [30] Sigmund O, Petersson J. Numerical instabilities in topology optimisation: a survey on procedures dealing with checkerboards, mesh-dependencies and local minima. *Struct Optim* 1998;16:68–75.
- [31] Eschenauer HA, Olhoff N. Topology optimisation of continuum structures: a review. *Appl Mech Rev* 2001;54(4):331–90.
- [32] Zhou M, Rozvany GIN. On the validity of ESO type methods in topology optimisation. *Struct Multidiscipl Optim* 2001;21(1):80–3.
- [33] Querin OM, Steven GP, Xie YM. Evolutionary structural optimisation (ESO) using a bi-directional algorithm. *Eng Comput* 1998;15(8):1031–48.
- [34] Bendsoe MP. Optimal shape design as a material distribution problem. *Struct Optim* 1989;1(4):193–202.
- [35] Bendsoe MP, Sigmund O. Topology optimisation: theory, methods, and applications. 2nd ed. Berlin: Springer Verlag; 2003.
- [36] Stolpe M, Svanberg K. On the trajectories of penalisation methods in topology optimisation. *Struct Multidiscipl Optim* 2001;21:128–39.
- [37] Cervellera P, Zhou M, Schramm U. Optimisation driven design of shell structures under stiffness, strength and stability requirements. In: 6th world congress of structural and multidisciplinary optimisation, 30th May – 3rd June 2005. Rio de Janeiro, Brazil; 2005.

- [38] Poulsen TA. A new scheme for imposing minimum length scale in topology optimisation. *Int J Numer Method Eng* 2003;57(6):741–60.
- [39] Altair Engineering Inc. Hyperworks 11.0; Radioss, motion solve and optistruct user's guide; 2012.
- [40] Zhou M, Fleury R, Shyy YK, Thomas H, Brennan JM. *Progress in topology optimisation with manufacturing constraints*. United States of America: American Institute of Aeronautics; 2002.
- [41] Stromberg LL, Beghini A, Baker WF, Katz N, Paulino GH. *Connecting engineering and architecture through structural topology optimisation*; 2011.
- [42] Leiva JP. A topology optimization method to extract optimal beam-like, plate-like, or shell-like structures from a solid finite element mesh. In: *Eng Opt, 3rd International Conference on Engineering Optimization*, Rio de Janeiro, Brazil; 01–05 July 2012.
- [43] Tsavdaridis KD, D'Mello C. Web buckling study of the behaviour and strength of perforated steel beams with different novel web opening shapes. *J Constr Steel Res* 2011;67(10):1605–20.
- [44] Tsavdaridis KD, D'Mello C. Finite element investigation on web-post buckling of perforated steel beams with various web opening shapes subjected under different shear-moment interaction. In: *6th European conference on steel and composite structures – EUROSTEEL*, 31 August – 2 September 2011, vol. C. Budapest, Hungary; 2011. p. 1851–56.
- [45] Tsavdaridis KD, D'Mello C. *Vierendeel bending study of perforated steel beams with various novel shapes of web openings, through non-linear finite element analyses*. *J Struct Eng, ASCE* 2012;138(10):1214–30.